



**memmert**

# Incubators

PERFECTLY COORDINATED. PERFECTLY CONTROLLED.

INCUBATOR I

CO<sub>2</sub> INCUBATOR ICO

COMPRESSOR-COOLED INCUBATOR IC<sub>Peco</sub>/ICP

PELTIER-COOLED INCUBATOR IPP<sub>Peco</sub>

**MADE IN GERMANY.**

[www.memmert.com](http://www.memmert.com)



# Stable. Safe. Sensitive.

Memmert incubators for microbiology.  
Energy efficient and precise.

Even slight temperature deviations in the working chamber of an incubator may cause a test to fail. For this reason, the heating and control system of Memmert incubators are perfectly adapted to each other. During heating up and cooling down as well as in running operation, all appliances precisely keep the desired parameters within the smallest tolerance limits. Not only at one measuring point, but in the entire working chamber. Each individual Memmert incubator complies with the strict requirements of DIN 12880:2007-05 and is equipped with a maximum of safety functions.

**INCUBATORS I****PAGE 4 - 8**

Microbiological tests, colony counts, virology, toxicology

**CO<sub>2</sub> INCUBATORS ICO****PAGE 9 - 14**

Microbiological tests, colony counts, virology and toxicology

**COMPRESSOR-COOLED INCUBATORS ICP<sub>eco</sub>****PAGE 15 - 19**

Microbiological tests, colony counts, virology, toxicology, cultivation above and below room temperature, alternate stability tests

**COMPRESSOR-COOLED INCUBATORS ICP****PAGE 20 - 21**

Microbiological tests, colony counts, virology, toxicology, cultivation above and below room temperature, alternate stability tests

**PELTIER-COOLED INCUBATORS IPP<sub>eco</sub>****PAGE 22 - 26**

Protein crystallography, microbiological tests, colony counts, virology, toxicology, cultivation above and below room temperature, alternate stability tests

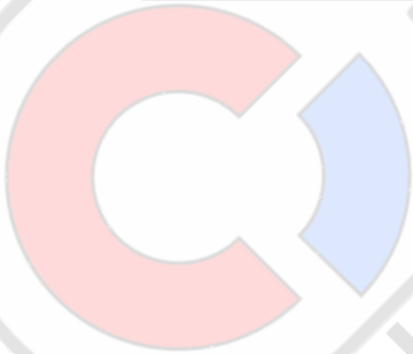
**ADDITIONAL INFORMATION****PAGE 27**



Incubator IN and IF with SingleDISPLAY  
Incubator INplus and IFplus  
with TwinDISPLAY  
Natural convection or forced air circulation  
AtmoCONTROL software

Model sizes:  
30 / 55 / 75 / 110 / 160 / 260 / 450 / 750  
+20 °C to +80 °C

**INCUBATOR I** Memmert incubators I are at home in the world of research, pharmaceuticals and food technology. The heating and control system are especially optimised for low temperatures of up to +80 °C. To prevent temperature overshoots, temperature is increased within a very narrow control range and kept exactly at the setpoint value. As required, the models with natural convection or with forced air circulation are available.

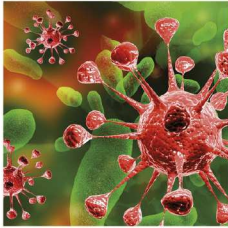
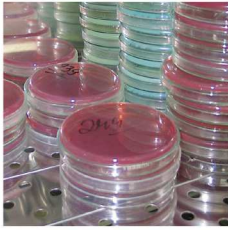

## As little air circulation as possible in the incubator

Forced air convection may destroy the protective layer from moist air that is generated during incubation over the samples. This would lead to dehydration of the culture. In a Memmert incubator, the perfect combination of all-round surface heating and temperature control system ensures that incubation generally takes place without forced air circulation. Provided the chamber is fully loaded and forced air circulation is required, it can be precisely adjusted in 10 % steps from 0 to 100 %.

## Sterilisation

The chamber of the incubators INplus/IFplus, including all installations and sensors, can be sterilised at +160 °C in a 4-hour programme to guarantee optimum hygiene.

## Fresh air is preheated

Temperature deviations caused by fresh air can influence sample characteristics or prolong drying. In Memmert incubators, the fresh air is therefore fed through a pre-heating chamber and seamlessly introduced into the working chamber.

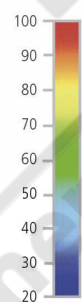

Temperature [°C]

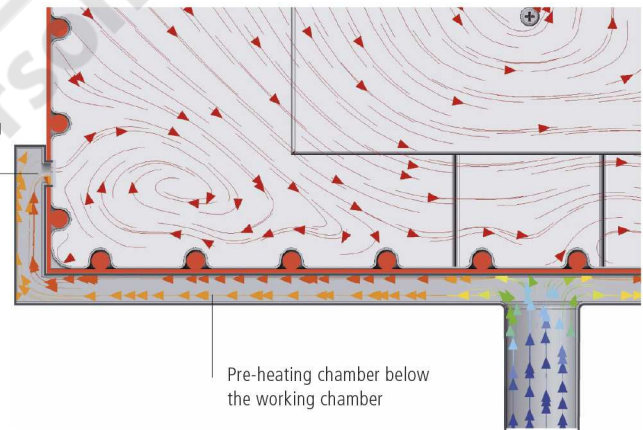

Pre-heating chamber below the working chamber

Air supply from outside

## INCUBATORS I

according to DIN 12880:2007-05, EN 61010-1 (IEC 61010-1), EN 61010-2-010

Standard units are safety-approved and bear the test marks:



**Interior:** Stainless steel, material 1.4301 (ASTM 304) with all-round deep-drawn ribs to integrate the large-area heating with ceramic-metal sheath

**Housing:** Textured stainless steel, rear zinc-plated steel, intuitively operated SingleDISPLAY or TwinDISPLAY (TFT colour display) with touchscreen; inner glass door, outside fully insulated stainless steel door (from size 450 two leaves)

**Fresh air:** Admixture of pre-heated fresh air by electronically adjustable airflap

**Connection:** Mains cable with plug (German type)

**Installation:** 4 feet; sizes 450/750 mounted on lockable castors

**Interfaces:**  

USB: only TwinDISPLAY

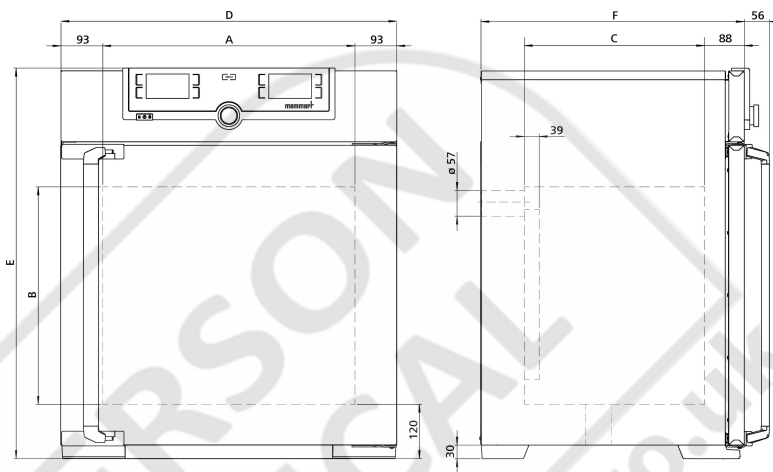

Model sizes/Description			30	55	75	110	160	260	450	750	
Stainless steel interior	Volume	approx. l	32	53	74	108	161	256	449	749	
	Width	(A) mm	400		560		640		1040		
	Height	(B) mm	320	400	560	480	720	800	720	1200	
	Depth (less 39 mm for fan)	(C) mm	250	330		400		500		600	
	Max. number of grids/shelves	number	3	4	6	5	8	9	8	14	
	Max. loading per grid/shelf	kg	20						30		
	Max. loading of chamber	kg	60	80	120	175	210	300			
	Max. loading per slide-in drip tray	kg	1,5		3		4		8		
Max. loading per bottom drip tray	kg	1,5		3		4		8			
Textured stainless steel exterior	Width	(D) mm	585		745		824		1224		
	Height (size 450, 750 with castors)	(E) mm	704	784	944	864	1104	1183	1247	1720	
	Depth (without door handle, depth of handle +56 mm)	(F) mm	434	514		584		684		784	
Standard equipment	Stainless steel grids, electropolished	number	1			2					
	Standard works calibration certificate (measuring point chamber center)	°C	+37								
Temperature	Working temperature range	°C	at least 5 (IN/INplus) 10 (IF/IFplus) above ambient temperature up to +80								
	Setting temperature range	°C	+20 to +80								
	Setting accuracy	°C	0.1								
Further data	Electrical load at 230 V, 50/60 Hz	approx. W	1600	1000	1250	1400	1600	1700	1800	2000	
	Electrical load at 115 V, 50/60 Hz	approx. W	800	900			1500		1800		
Packing data	Net weight	approx. kg	48	57	66	76	96	110	161	217	
	Gross weight (packed in carton)	approx. kg	64	76	85	101	122	161	227	288	
	Width	approx. mm	660	730		830		930		1330	
	Height	approx. mm	890	950	1130	1050	1300	1380	1440	1910	
	Depth	approx. mm	650	670		800		930		1050	
<b>Order No. Incubators</b>		<b>IN30</b>	<b>IN55</b>	<b>IN75</b>	<b>IN110</b>	<b>IN160</b>	<b>IN260</b>	<b>IN450</b>	<b>IN750</b>		
I = Incubator		<b>IN30plus</b>	<b>IN55plus</b>	<b>IN75plus</b>	<b>IN110plus</b>	<b>IN160plus</b>	<b>IN260plus</b>	<b>IN450plus</b>	<b>IN750plus</b>		
N = Natural convection		<b>IF30</b>	<b>IF55</b>	<b>IF75</b>	<b>IF110</b>	<b>IF160</b>	<b>IF260</b>	<b>IF450</b>	<b>IF750</b>		
F = Forced convection		<b>IF30plus</b>	<b>IF55plus</b>	<b>IF75plus</b>	<b>IF110plus</b>	<b>IF160plus</b>	<b>IF260plus</b>	<b>IF450plus</b>	<b>IF750plus</b>		
plus = Model with TwinDISPLAY											

Options	30	55	75	110	160	260	450	750
Voltage 115 V, 50/60 Hz								X2
Extended overtemperature protection by additionally integrated Pt100 sensor for independent temperature monitoring for models with SingleDISPLAY								A6
Chamber modification for the application of reinforced perforated stainless steel shelves or stainless steel grids (bearing rails mounted in the working chamber) - includes replacement of standard grids by reinforced grids								K1
Interior lighting for observing the load								R0
Interior socket (can only be ordered with limited temperature range - max. +70 °C), ampacity 230 V, 2.2 A, can be switched off with the On/Off switch, cannot be switched individually, moisture tight IP68 (only with SingleDISPLAY), (option A8 necessary)								R3
Entry port, 23 mm clear diameter, for introducing connections at the side, can be closed by flap and silicone stopper, standard positions								F0 F1 F2 F3
Entry port, 23 mm clear diameter, can be closed by flap, in special positions (please state location)								F4 F5 F6
Entry port, 14 mm clear diameter, can be closed by flap, in special positions in the back wall (please state location)								D6
Entry port, 38 mm clear diameter, can be closed by flap, in special positions in the back wall (please state location)								F7
Entry port, 57 mm clear diameter, can be closed by flap, in special positions in the back wall (please state location; not possible for IF/IFplus size 30-75)								F8
Entry port, 100 mm clear diameter, can be closed by flap, in special positions in the back wall (please state location; not possible for IF/IFplus size 75)								F9
4 - 20 mA current loop interface (0 to +90 °C = 4 - 20 mA)								V3 V6
Temperature controller, actual value of a Pt100 sensor positioned flexibly in chamber for external temperature monitoring (max. 1 SingleDISPLAY, max. 3 TwinDISPLAY) - price per sensor								
Fan speed monitoring with switching-off the heating and with alarm in case of failure - only for IFplus								V4
Works calibration certificate for 3 temperatures: +37, +52, +70 °C								D00126
Works calibration certificate for one (freely selectable) temperature value according to customer specification								D00109
Door with lock and key (safety lock)								B6
Door hinged on the left								B8
Potential-free contact for combination error message (e.g. supply failure, sensor fault, fuse)								H6
Door-open-recognition (only for units with TwinDISPLAY)								V5
MobileALERT, notification by SMS in case of any error or alarm of the device (requires option H6)								C3
Temperature restriction; Temperatures: +50, +55, +60, +65, +70 or +75 °C (Please indicate upon ordering)								A8
Fresh-air filter (filtration efficiency 80 %) mounted at the appliance bottom (for IF/IFplus, for sizes 30 – 260 requires castor frame R9 or subframe)								R8
Castor frame (2-part), height 140 mm								R9
								-
Accessories	30	55	75	110	160	260	450	750
Stainless steel grid, electropolished	E28884	E20164		E20165		E28891		E20182
Reinforced stainless steel grid, electropolished, max. loading 60 kg; from size 450 with guide bars and fixing screws (only in connection with option K1). Please consider max. loading of chamber				E29767		E29766		B32190
Perforated stainless steel shelf	B29727	B03916		B00325		B29725		B00328
Reinforced stainless steel shelf, max. loading 60 kg; with guide bars and fixing screws (requires option K1). Please consider max. loading of chamber								B32191
Stainless steel slide-in drip tray, 15 mm rim (may affect the temperature distribution, not in connection with option K1)	E02070	E02072		E02073		E29726		E02075
Stainless steel slide-in drip tray, 15 mm rim, with guide bars and fixing screws (may affect the temperature distribution, only in connection with option K1)								B32763
Stainless steel bottom drip tray, 15 mm rim (may affect the temperature distribution, not in connection with option K1)	B04356	B04358		B04359		B29722		B04362
Stainless steel bottom drip tray, 15 mm rim (may affect the temperature distribution, only in connection with option K1)								B34055
Wall bracket for wall mounting	B29755	B29756	B29757	B29758	B29759			-
Guarantee extension by 1 year			GA1Q5					GA2Q5
USB-Ethernet adapter						E06192		
Ethernet connection cable 5 m for computer interface						E06189		

Accessories	30	55	75	110	160	260	450	750
USB User-ID stick (with User-ID licence): Oven-linked authorisation licence (User-ID-programme) on Memory-stick, prevents undesired manipulation by unauthorised third parties. When reordering please specify serial number (only for units with TwinDISPLAY)	B33170							
USB stick with documentation software AtmoCONTROL and operation manual for products with SingleDISPLAY (the standard equipment of appliances with TwinDISPLAY includes one USB stick with AtmoCONTROL). When reordering please specify serial number	B33172							
Set of height adjustable feet (4 pcs)	B29768						-	
Stacking set (4 pcs) for stacking of appliances of same size	B29744				-			
Plug-in tube extension (outer diam. 60.3 mm, inner 57 mm), straight, for exhaust air ducting (if necessary for connection by hose)	B29718							
Plug-in tube extension (outer diam. 60.3 mm, inner 57 mm), angled, for exhaust air ducting (if necessary for connection by hose)	B29719							
Flush-fit unit (stainless steel frame covering gap between oven and wall opening), with air slots	B29728	B29730	B29732	B29734	B29736	B29738	B29740	B29742
Flush-fit unit (stainless steel frame covering gap between oven and wall opening), without air slots	B29729	B29731	B29733	B29735	B29737	B29739	B29741	B29743
Subframe, adjustable in height (size 30 to 75: height 600 mm, size 110 to 450: height 500 mm)	B29745	B29747		B29749		B29751	B29753	-
Subframe, on castors (size 30 to 75: height 660 mm, size 110 to 160: height 560 mm)	B29746	B29748		B29750		-		
Subframe, adjustable in height, height 130 mm, for example for units with fresh air filter	B33657	B33659		B33661		B33664	-	
Software conforming to FDA AtmoCONTROL. Meets the requirements for the use of electronically stored data sets and electronic signatures as laid down in Regulation 21 CFR Part 11 of the US Food and Drug Administration (FDA). Base licence for the control of one unit (only for units with TwinDISPLAY). Respective IQ/OQ documents available in German and English language (without surcharge)	FDAQ1							
Integration of one additional unit (up to max. 31 units) into an already existent FDA-software licence (only for units with TwinDISPLAY)	FDAQ2							
DAkkS calibration for one free-selectable temperature value according to method C (DKD-R 5-7)	E39696							
DAkkS calibration for further temperature values according to method C (DKD-R 5-7)	E39697							
IQ document with device-specific works test data, OQ/PQ check list as support for validation by customer	D00124							
IQ/OQ document with device-specific works test data for one free-selectable temperature value, incl. temperature distribution survey at Memmert for 9 measuring points (size 30), 27 measuring points (sizes 55 - 1060) to DIN 12880:2007-05. PQ check list as support for validation by customer. 305 € for further temperature values	D00125		D00127					
On-site IQ/OQ for a freely selectable temperature value, including temperature distribution survey for 9 measuring points (size 30), 27 measuring points (sizes 55 - 750) to DIN 12880:2007-05 (excluding travel costs, not subject to discount, GER, AT, FR only)	DLQ100							
Extension of DLQ100 by an additional freely selectable temperature value (not subject to discount)	DLQ100A							
Individual on-site Performance Qualification (PQ)	DLQ200							
Maintenance UIS - carrying out and documentation according to Memmert maintenance plan (excluding travel costs, not subject to discount, GER, AT, FR only)	S00311							
Maintenance contract UIS - carrying out and documentation according to Memmert maintenance plan, minimum duration 3 years (excluding travel costs, not subject to discount, GER, AT, FR only)	S00311J							
Calibration of one freely selectable temperature value (excluding travel costs, not subject to discount, GER, AT, FR only)	S00205							
Calibration of an additional temperature value (not subject to discount)	S00215							



Lined area for personal notes, featuring a large watermark logo for Henderson Biomedical and the website address www.henderson-biomedical.co.uk.





CO<sub>2</sub> Incubator ICO with TwinDISPLAY  
AtmoCONTROL software

Model sizes: 50 / 105 / 150 / 240

+18 °C to +50 °C

Humidity 40 to 97 % rh

CO<sub>2</sub> concentration 0 to 20 %

O<sub>2</sub> concentration 1 to 20 %

**CO<sub>2</sub> INCUBATOR ICO** Safety at all times. When it comes to safety and user friendliness, the highly modern CO<sub>2</sub> incubator ICO is the perfect solution: Thanks to the battery-buffered ControlCOCKPIT, the operating display, logging and CO<sub>2</sub> control remain fully functional even when there is a power failure. All parameters are logged in accordance with the FDA and, when individually adjusted ranges for CO<sub>2</sub>, O<sub>2</sub>, temperature and humidity are exceeded, notifications can be sent to a mobile phone in addition to an alarm.

The control technology is so finely tuned that the setpoint temperature is guaranteed to be reached without temperature overshoots. With its rounded corners, the interior is easy to clean and can be sterilised for 60 minutes at 180 °C (including all sensors).

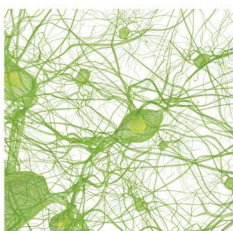

## Unrivalled user friendliness

All parameters can be set easily and intuitively both with the ControlCOCKPIT or the AtmoCONTROL software. The shutter box can be opened, allowing fast access to controls. Maintenance is possible even if the appliances are stacked. The appliance has USB and Ethernet connections as well as a data logger with a ten-year storage capacity. Data can be read and programmes can be transferred by remote access.



## Minimising vaporisation and condensation

The active humidity control minimises vaporisation in the interior and ensures short recovery times after the door has been opened. Together with the heating of the interior from all six sides including the heated inner glass door, it prevents the dangerous formation of condensation and offers maximum protection for cell and tissue cultures. The turbulence-free chamber ventilation ensures a constant and uniform atmosphere.





HENDERSON  
BIOMEDICAL  
www.henderson-biomedical.co.uk



CO<sub>2</sub> INCUBATORS ICO

according to DIN 12880:2007-05, EN 61010-1 (IEC 61010-1), EN 61010-2-010

Standard units are safety-approved and bear the test marks:   

Interior: Stainless steel, material 1.4301 (ASTM 304), deep-drawn, seamlessly welded

Housing: Textured stainless steel, rear zinc-plated steel, intuitively operated TwinDISPLAY (TFT colour display) with touchsreen; fully insulated stainless steel door and heated inner glass door

Automatic sterilisation: Humidity and CO<sub>2</sub> sensor sterilised inside the CO<sub>2</sub> incubator

Connection: Mains cable with plug (German type)

Installation: 4 adjustable feet

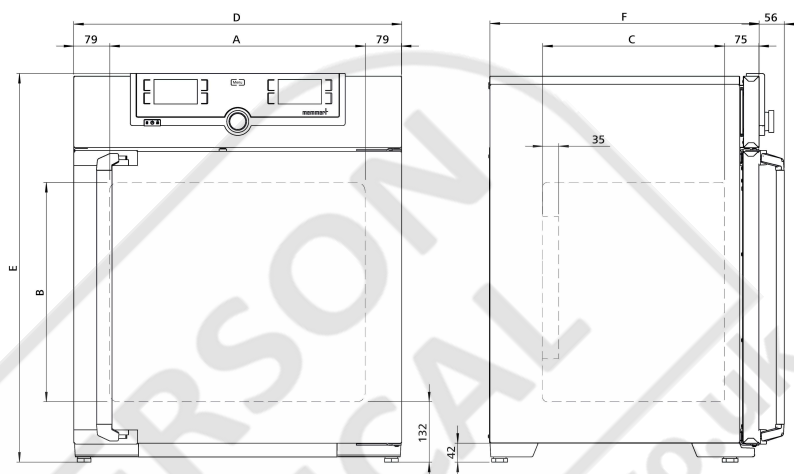
Interfaces:  

Model sizes/Description			50	105	150	240
Stainless steel interior	Volume	approx. l	56	107	156	241
	Width	(A) mm	400	560	600	600
	Height	(B) mm	425	480	700	810
	Depth (less 35 mm for fan)	(C) mm	330	400	500	500
	Max. number of perforated shelves	number	5	6	10	12
	Max. loading per perforated shelf	kg	15			
Textured stainless steel exterior	Max. loading of chamber	kg	75	90	120	140
	Width	(D) mm	559	719	759	759
	Height (variable through adjustable feet)	(E) mm	795	850	1070	1180
	Depth (without door handle, depth of handle +56 mm)	(F) mm	521	591	691	691
	Fully insulated heated stainless steel door			●		
	Additional heated inner glass door			●		
Standard equipment	Stainless steel shelves, perforated	number	1	2		
	Stainless steel water dish (not applicable with option K7)	number		1		
	Works calibration certificate (measuring point chamber centre) at +37 °C, 5 % CO <sub>2</sub> for standard units			●		
	Works calibration certificate at +37 °C, 5 % CO <sub>2</sub> , 90 % rh and 10 % O <sub>2</sub> (requires option K7 and option T6); standard equipment for units with O <sub>2</sub> control			●		
	Works calibration certificate at +37 °C, 5 % CO <sub>2</sub> and 90 % rh (requires option K7); standard equipment for units with active humidity control			●		
	CO <sub>2</sub> connection set: hose with coupling and clamp			●		
	Standard sterilisation programme (without removing the sensors), humidity and CO <sub>2</sub> sensor sterilised inside the CO <sub>2</sub> incubator			60 minutes at 180 °C		
Temperature	Membrane filter (in order to remove impurities and pollutants, all incoming gases pass through a membrane filter before they reach the chamber)			●		
	Working temperature range	°C	at least 5 above ambient temperature up to +50			
	Setting temperature range	°C	+18 to +50			
	Setting accuracy	°C	0.1			
	Temperature fluctuations with time at +37 °C	K	+/- 0.1			
Humidity	Temperature variation in chamber at +37 °C	K	+/- 0.3			
	Humidity limitation thanks to a Peltier element; when water dish is full and inserted, the Peltier element limits the value of relative humidity in the interior to 93 % rh +/- 2.5 %		●			
	Setting range active humidity control (with option K7)	% rh	40 to 97 and rh-Off			
CO <sub>2</sub> / O <sub>2</sub>	Setting accuracy	% rh	0.5			
	Digital electronic CO <sub>2</sub> control with dual beam NDIR system, with auto-diagnostic system and acoustic fault indication, barometric pressure compensation		●			
	Setting range CO <sub>2</sub>	% CO <sub>2</sub>	0 to 20			
	Variation in time CO <sub>2</sub>	% CO <sub>2</sub>	+/- 0.2			
	Setting accuracy CO <sub>2</sub>	% CO <sub>2</sub>	0.1			
Further data	Setting range O <sub>2</sub>	% O <sub>2</sub>	1 to 20			
	Setting accuracy O <sub>2</sub>	% O <sub>2</sub>	0.1			
Further data	Electrical load at 230/115 V, 50/60 Hz	approx. W	1100	1300	1500	1650

Model sizes/Description		50	105	150	240	
Packing data	Net weight	approx. kg	55	75	90	110
	Gross weight (packed in carton)	approx. kg	74	100	116	145
	Width	approx. mm	730	800		840
	Height	approx. mm	950	1030	1250	1360
	Depth	approx. mm	640	800		900
<b>Order No. CO<sub>2</sub> Incubators</b>			<b>ICO50</b>	<b>ICO105</b>	<b>ICO150</b>	<b>ICO240</b>
Options		50	105	150	240	
Voltage 115 V, 50/60 Hz				X2		
Battery-buffered ControlCOCKPIT: Uninterrupted supply for the entire display unit (ControlCOCKPIT) and therefore complete documentation of all parameters even when there is a power failure. The CO <sub>2</sub> parameter is continuously regulated				C2		
Two gas connections with quick release connectors for automatic switch-over of gas cylinders; incl. two CO <sub>2</sub> connection sets: hose with coupling and clamp				T1		
Electropolished interior				T2		
Active microprocessor control for humidifying and dehumidifying (40 - 97 % rh), incl. digital indication and auto-diagnostic system ensures even more rapid reaching of set humidity and very short recovery times while avoiding condensate formation. Humidity supply with water (only for demineralised water with a conductivity of 5 to 10 µS/cm and a pH value between 5 and 7; from an external tank) by a self-priming pump; integral bacteria block by generating hot steam, dehumidifying via sterile filter (combination of options K7 and F7 for ICO50 not possible)				K7		
Control of oxygen concentration by N <sub>2</sub> inlet; adjustment range 1 % up to 20 % O <sub>2</sub> ; setting accuracy 0.1 % (requires option K7). Incl. N <sub>2</sub> connection set: hose with coupling and clamp				T6		
Peltier cooling unit enables a working temperature of +37 °C even at higher ambient temperatures of up to +35 °C				K5		
Capacitive humidity sensor for measuring and displaying the relative humidity				K6		
Entry port (silicone), 40 mm clear diameter, moisture tight, can be closed by silicone stopper, at the back, centre right; not available for ICO50 with active humidity control (option K7) or humidity display (option K6)				F7		
Heated inner door with partitioned glass doors; size105/150/240 has 2/3/4 partitioned glass doors		-		K4		
4 - 20 mA current loop interface	Temperature controller, actual value (0 to +70 °C = 4 - 20 mA)			V3		
	Humidity controller, actual value (0 to 100 % rh = 4 - 20 mA) (requires option K7 or K6)			V7		
	CO <sub>2</sub> controller, actual value (0 to 25 % CO <sub>2</sub> = 4 - 20 mA)			V9		
	O <sub>2</sub> controller, actual value (0 to 25 % O <sub>2</sub> = 4 - 20 mA) (requires option T6)			V1		
Works calibration certificate for 5 %, 7 % and 10 % CO <sub>2</sub> (measured at +37 °C) special works calibration certificates upon request				D00106		
Works calibration certificate for one (freely selectable) temperature, humidity and CO <sub>2</sub> value according to customer specification (requires option K7)				D00131		
Works calibration certificate for one (freely selectable) temperature, humidity, CO <sub>2</sub> and O <sub>2</sub> value according to customer specification (requires option T6)				D00143		
Door hinged on the left				B8		
Potential-free contact for combination error message (e.g. supply failure, sensor fault, fuse)				H6		
MobileALERT, notification by SMS in case of any error or alarm of the device (requires option H6)				C3		
MobileALERT for up to 4 alarm notifications; notification by SMS. temperature and CO <sub>2</sub> alarm (standard), additionally humidity alarm (when equipped with option K7) and O <sub>2</sub> alarm (when equipped with option T6)				C4		
Door with lock and key (safety lock)				B6		
Accessories		50	105	150	240	
Perforated stainless steel shelf		E35160	E37418	E35158		
Water dish			B38737			
Subframe (622 mm high) adjustable in height (sizes 150/240: should not be used for 2 stacked units)		B33504	B33505	B33506		
Subframe (130 mm high); sizes 150/240: only in combination with the corresponding stacking sets for stacked appliances		B33507	B33508	B33509		
Subframe, on castors (height 120 mm; stainless steel, material 1.4301)			-	B43598		
HEPA14-filter for chamber according to EN 1822, packed in sterile condition, incl. fixing unit			B49800			
3 HEPA14-filters (B49800) for chamber according to EN 1822, packed in sterile condition, incl. fixing unit			B39698			
CO <sub>2</sub> pressure reducing valve to DIN 8546, incl. gas cylinder monitor			E02087			
N <sub>2</sub> pressure reducing valve to DIN EN ISO 2503, incl. gas cylinder monitor (requires option T6)			E06162			
Central water supply, with filter cartridges for connection to the domestic water supply (requires option K7). Product information on demand			ZWVR6			
Central water supply, without filter cartridges for connection to the domestic water supply (only for demineralised water with a conductivity of 5 to 10 µS/cm and a pH value between 5 and 7, requires option K7). Product information on demand			ZWVR7			
Guarantee extension by 1 year			GA3Q5			
Celltron benchtop shaker (not subject to discount) - accessories upon request (only in combination with E06726)			-	E06724		
Base plate with sticky stuff (not subject to discount) (only in combination with E06724)			-	E06726		
USB-Ethernet adapter			E06192			

Accessories	50	105	150	240
Ethernet connection cable 5 m for computer interface			E06189	
USB User-ID stick (with User-ID licence): Oven-linked authorisation licence (User-ID-programme) on Memory-stick, prevents undesired manipulation by unauthorised third parties. When reordering please specify serial number			B33170	
Stacking set (4 pcs) for stacking of appliances of same size	B29744		-	
Stacking set (consisting of stacking corners, one connecting plate for the rear, two wall brackets) for stacking of two units of same size	-	B42114		-
Stacking set (consisting of stacking corners, one connecting plate for the rear, two wall brackets) for stacking of two units of same size (only in connection with subframe B33509 or B43598)	-			B48129
FDA conforming software AtmoCONTROL (FDA edition). Meets the requirements for the use of electronically stored data sets and electronic signatures as laid down in Regulation 21 CFR Part 11 of the US Food and Drug Administration (FDA). Base licence for the control of one unit. Respective IQ/OQ documents available in German and English language (without surcharge)			FDAQ1	
Integration of additional units (up to max. 31 units) into an already existent FDA-software licence			FDAQ2	
External measuring instrument with additional measuring head for temperature and humidity measurement. Product information on demand			B04714	
DAkkS calibration for one (freely selectable) temperature and humidity value according to method C (DKD-R 5-7) (requires option K7)			E48847	
DAkkS calibration for further temperature and humidity values according to method C (DKD-R 5-7) (requires option K7)			E48848	
IQ document with device-specific works test data, OQ/PQ check list as support for validation by customer			D00124	
IQ/OQ document with device-specific works test data for one free-selectable CO <sub>2</sub> and temperature value, incl. temperature distribution survey at Memmert for 27 measuring points to DIN 12880:2007-05, PQ check list as support for validation by customer. 475 € for further CO <sub>2</sub> and temperature values			D38898	
IQ/OQ document with device-specific works test data for one free-selectable CO <sub>2</sub> , humidity and temperature value, incl. temperature distribution survey at Memmert for 27 measuring points to DIN 12880:2007-05, PQ check list as support for validation by customer (requires option K7). 605 € for further CO <sub>2</sub> , humidity and temperature values			D38897	
On-site IQ/OQ for a freely selectable temperature and CO <sub>2</sub> value, including temperature distribution survey for 27 measuring points to DIN 12880: 2007-05 (excluding travel costs, not subject to discount, GER, AT, FR only)			DLQ102	
Extension of DLQ102 by an additional freely selectable temperature and CO <sub>2</sub> value (not subject to discount)			DLQ102A	
On-site IQ/OQ for a freely selectable temperature, humidity and CO <sub>2</sub> value, including temperature distribution survey for 27 measuring points to DIN 12880: 2007-05 (requires option K7) (excluding travel costs, not subject to discount, GER, AT, FR only)			DLQ103	
Extension of DLQ103 by an additional freely selectable temperature, humidity and CO <sub>2</sub> value (requires option K7) (not subject to discount)			DLQ103A	
On-site IQ/OQ for a freely selectable temperature, CO <sub>2</sub> and O <sub>2</sub> value, including temperature distribution survey for 27 measuring points to DIN 12880:2007-05 (requires option T6) (excluding travel costs, not subject to discount, GER, AT, FR only)			DLQ104	
Extension of DLQ104 by an additional freely selectable temperature, CO <sub>2</sub> and O <sub>2</sub> value (requires option T6) (not subject to discount)			DLQ104A	
On-site IQ/OQ for a freely selectable temperature, humidity, CO <sub>2</sub> and O <sub>2</sub> value, including temperature distribution survey for 27 measuring points to DIN 12880: 2007-05 (requires option K7 and T6) (excluding travel costs, not subject to discount, GER, AT, FR only)			DLQ105	
Extension of DLQ105 by an additional freely selectable temperature, humidity, CO <sub>2</sub> and O <sub>2</sub> value (requires option K7 and T6) (not subject to discount)			DLQ105A	
Individual on-site Performance Qualification (PQ)			DLQ200	
Maintenance ICO/ ICOfed active humidity - carrying out and documentation according to Memmert maintenance plan (requires option K7) (excluding travel costs, not subject to discount, GER, AT, FR only)			S00312	
Maintenance contract ICO/ ICOfed active humidity - carrying out and documentation according to Memmert maintenance plan, minimum duration 3 years (requires option K7) (excluding travel costs, not subject to discount, GER, AT, FR only)			S00312J	
Maintenance ICO/ ICOfed passive humidity - carrying out and documentation according to Memmert maintenance plan (excluding travel costs, not subject to discount, GER, AT, FR only)			S00323	
Maintenance contract ICO/ ICOfed passive humidity - carrying out and documentation according to Memmert maintenance plan, minimum duration 3 years (excluding travel costs, not subject to discount, GER, AT, FR only)			S00323J	
Calibration of one freely selectable temperature value (excluding travel costs, not subject to discount, GER, AT, FR only)			S00205	
Calibration of an additional temperature value (not subject to discount)			S00215	
Calibration of one freely selectable temperature and humidity value (requires Option K7) (excluding travel costs, not subject to discount, GER, AT, FR only)			S00207	
Calibration of an additional temperature and humidity value (requires option K7) (not subject to discount)			S00216	
Calibration of one freely selectable temperature and humidity value including CO <sub>2</sub> (requires option K7) (excluding travel costs, not subject to discount, GER, AT, FR only)			S00211	
Calibration of an additional temperature and humidity value including CO <sub>2</sub> (requires option K7) (not subject to discount)			S00217	

HENDERSON  
BIOMEDICAL  
www.henderson-biomedical.co.uk



KEEP COOL.  
WE CARE

CO<sub>2</sub>-cooled incubator ICPeco  
with TwinDISPLAY  
AtmoCONTROL software

Model sizes: 110 / 260 / 450 / 750  
-12 °C to +60 °C

**COMPRESSOR-COOLED INCUBATOR ICPeco** These environmentally-friendly cooled incubators are cooled with climate-friendly CO<sub>2</sub>. Thanks to this refrigerant's excellent thermodynamic properties and the finely adjusted control technology, an ICPeco is both powerful and high-precision. Without critical temperature overshoots, it keeps the temperatures exactly at the setpoint.





## Refrigerant CO<sub>2</sub> is climate-friendly

A CO<sub>2</sub>-cooled incubator ICPeco is in every respect positive for the ecological balance of a laboratory. Legal restrictions for use are completely excluded in the future, as the refrigerant CO<sub>2</sub> (R744), unlike fluorine-based refrigerants, has no greenhouse gas reduction potential. It is a by-product of industrial processes, which is why far less energy is used for its manufacture than for synthetic, fluorinated refrigerants. R744 is neither flammable nor toxic and does not cause ozone depletion in the atmosphere.



## Refrigerant CO<sub>2</sub> ensures better cooling performance

The contribution to process optimisation is also impressive. An ICPeco is extremely powerful. Compared to appliances with R134a as refrigerant, it has faster temperature change rates during cooling-down.



## Completely enclosed working chamber

Cooling and heating units are situated outside the working chamber inside the air jacket temperature control system surrounding the entire chamber interior ensuring quick and precise temperature control. The motor-driven forced air circulation, adjustable in 10 % steps via the ControlCOCKPIT ensures optimum temperature distribution.

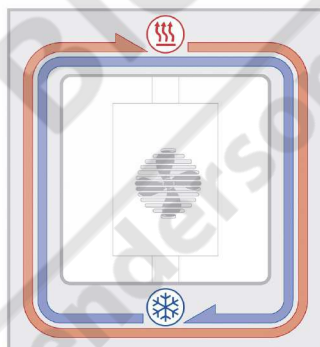
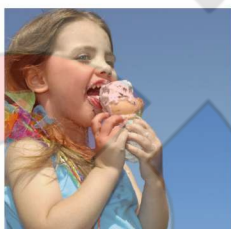

ICP air jacket temperature control system

## Integrated energy saving function

The cooling unit works extremely energy-efficient because the heating is completely switched off in cooling mode. An intelligent DEFROST function enables defrosting as required.



## COMPRESSOR-COOLED INCUBATORS ICPeco

according to DIN 12880:2007-05, EN 61010-1 (IEC 61010-1), EN 61010-2-010

Standard units are safety-approved and bear the test marks: 

**Interior:** Stainless steel, material 1.4301 (ASTM 304)  
**Housing:** Textured stainless steel, rear zinc-plated steel, intuitively operated TwinDISPLAY (TFT colour display) with touchscreen; inside glass door, outside fully insulated stainless steel door (from size 450 two leaves)

**Connection:** Mains cable with plug (German type)

**Installation:** Mounted on lockable castors

**Interfaces:**

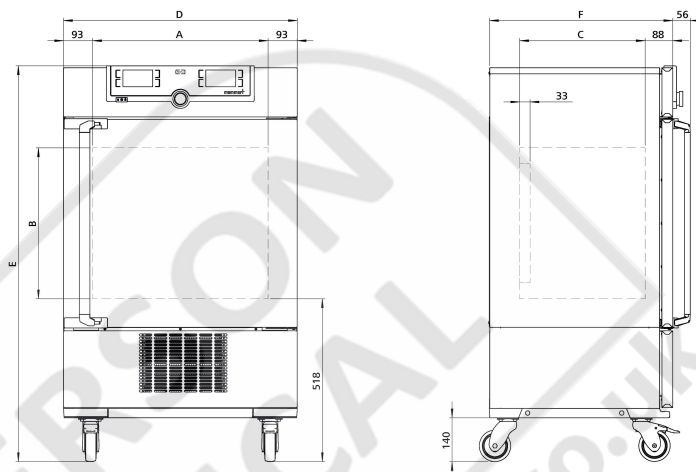

Model sizes/Description			110	260	450	750
Stainless steel interior	Volume	approx. l	108	256	449	749
	Width	(A) mm	560	640	1040	
	Height	(B) mm	480	800	720	1200
	Depth (less 33 mm for fan)	(C) mm	400	500	600	
	Max. number of grids/shelves	number	5	9	8	14
	Max. loading per grid/shelf	kg	20		30	
	Max. loading of chamber	kg	150	200		
	Max. loading per slide-in drip tray	kg	3	4	8	
	Max. loading per bottom drip tray	kg	3	4	8	
Textured stainless steel exterior	Width	(D) mm	745	824	1224	
	Height (with castors)	(E) mm	1233	1552	1467	1950
	Depth (without door handle, depth of handle +56 mm)	(F) mm	584	684	784	
Standard equipment	Stainless steel grids, electropolished	number	2			
	Standard works calibration certificate (measuring point chamber center)	°C	+10 and +37			
Temperature	Working temperature range (not suitable for long-term storing at sub-zero temperatures. During permanent operation, the inner glass door may ice over)	°C	-12 to +60			
	Setting temperature range	°C	-12 to +60			
	Setting accuracy	°C	0.1			
Further data	Electrical load at 230 V, 50 Hz	approx. W	1200			
Packing data	Net weight	approx. kg	118	162	222	254
	Gross weight (packed in carton)	approx. kg	146	219	287	324
	Width	approx. mm	880	930	1330	
	Height	approx. mm	1410	1760	1700	2150
	Depth	approx. mm	810	930	1050	

**Order No. Compressor-Cooled Incubators**

ICP110eco | ICP260eco | ICP450eco | ICP750eco

Options	110	260	450	750
Chamber modification for the application of reinforced perforated stainless steel shelves or stainless steel grids (bearing rails mounted in the working chamber) - includes replacement of standard grids by reinforced grids	-			K1
Interior socket, ampacity 230 V/2.2 A, can be switched off with the On/Off switch, cannot be switched individually, moisture tight IP68			R3	
Entry port, 23 mm clear diameter, for introducing connections at the side, can be closed by flap and silicone stopper, standard positions		left centre/centre left centre/top right centre/top	F0 F1 F3	
Entry port (silicone), 40 mm clear diameter, moisture tight, can be closed by silicone stopper, at the back (please state location)			F7	
4 - 20 mA current loop interface		Temperature controller, actual value (-20 to +70 °C = 4 - 20 mA)	V3	
		Temperature of a Pt100 sensor positioned flexibly in chamber for external temperature monitoring (max. 3) - price per sensor (-20 to +70 °C = 4 - 20 mA)	V6	
Fan speed monitoring with switching off the heating and with alarm in case of failure			V4	
Works calibration certificate for 3 temperatures: 0, +37, +60 °C			D00130	
Works calibration certificate for one (freely selectable) temperature value according to customer specification			D00109	
Door with lock and key (safety lock)			B6	
Potential-free contact for combination error message (e.g. supply failure, sensor fault, fuse)			H6	
Door-open-recognition			V5	
MobileALERT, notification by SMS in case of any error or alarm of the device (requires option H6)			C3	

Accessories	110	260	450	750
Stainless steel grid, electropolished	E20165	E28891		E20182
Reinforced stainless steel grid, electropolished, max. loading 60 kg; from size 450 with guide bars and fixing screws (only in connection with option K1). Please consider max. loading of chamber	E29767	E29766		B32190
Perforated stainless steel shelf	B00325	B29725		B00328
Reinforced stainless steel shelf, max. loading 60 kg; with guide bars and fixing screws (requires option K1). Please consider max. loading of chamber		-		B32191
Stainless steel slide-in drip tray, 15 mm rim (may affect the temperature distribution, not in connection with option K1)	E02073	E29726		E02075
Stainless steel slide-in drip tray, 15 mm rim, with guide bars and fixing screws (may affect the temperature distribution, only in connection with option K1)		-		B32763
Stainless steel bottom drip tray, 15 mm rim (may affect the temperature distribution, not in connection with option K1)	B04359	B29722		B04362
Stainless steel bottom drip tray, 15 mm rim (may affect the temperature distribution, only in connection with option K1)		-		B34055
USB-Ethernet adapter			E06192	
Ethernet connection cable 5 m for computer interface			E06189	
USB User-ID stick (with User-ID licence): Oven-linked authorisation licence (User-ID-programme) on Memory-stick, prevents undesired manipulation by unauthorised third parties. When reordering please specify serial number			B33170	
FDA conforming software AtmoCONTROL (FDA edition). Meets the requirements for the use of electronically stored data sets and electronic signatures as laid down in Regulation 21 CFR Part 11 of the US Food and Drug Administration (FDA). Base licence for the control of one unit. Respective IQ/OQ documents available in German and English language (without surcharge)			FDAQ1	
Integration of additional units (up to max. 31 units) into an already existent FDA-software licence			FDAQ2	
DAkkS calibration for one free-selectable temperature value according to method C (DKD-R 5-7)			E39696	
DAkkS calibration for further temperature values according to method C (DKD-R 5-7)			E39697	
IQ document with device-specific works test data, OQ/PQ check list as support for validation by customer			D00124	
IQ/OQ document with device-specific works test data for one free-selectable temperature value, incl. temperature distribution survey at Memmert for 27 measuring points to DIN 12880:2007-05. PQ check list as support for validation by customer. 305 € for further temperature values			D00127	
On-site IQ/OQ for a freely selectable temperature value, including temperature distribution survey for 27 measuring points to DIN 12880: 2007-05 (excluding travel costs, not subject to discount, GER, AT, FR only)			DLQ100	
Extension of DLQ100 by an additional freely selectable temperature value (not subject to discount)			DLQ100A	
Individual on-site Performance Qualification (PQ)			DLQ200	
Maintenance ICP/ ICPEco - carrying out and documentation according to Memmert maintenance plan (excluding travel costs, not subject to discount, GER, AT, FR only)			S00315	
Maintenance contract ICP/ ICPEco - carrying out and documentation according to Memmert maintenance plan, minimum duration 3 years (excluding travel costs, not subject to discount, GER, AT, FR only)			S00315J	
Calibration of one freely selectable temperature value (excluding travel costs, not subject to discount, GER, AT, FR only)			S00205	
Calibration of an additional temperature value (not subject to discount)			S00215	

## COMPRESSOR-COOLED INCUBATORS ICP

according to DIN 12880:2007-05, EN 61010-1 (IEC 61010-1), EN 61010-2-010

Standard units are safety-approved and bear the test marks: 

**Interior:** Stainless steel, material 1.4301 (ASTM 304)  
**Housing:** Textured stainless steel, rear zinc-plated steel, intuitively operated TwinDISPLAY (TFT colour display) with touchscreen; inside glass door, outside fully insulated stainless steel door (from size 450 two leaves)

**Connection:** Mains cable with plug (German type)

**Installation:** Mounted on lockable castors

**Interfaces:**

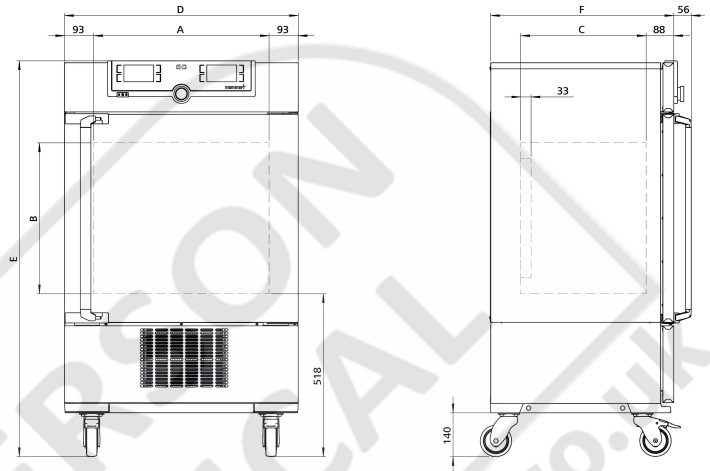
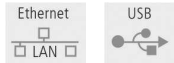

Model sizes/Description			110	260	450	750
Stainless steel interior	Volume	approx. l	108	256	449	749
	Width	(A) mm	560	640	1040	
	Height	(B) mm	480	800	720	1200
	Depth (less 33 mm for fan)	(C) mm	400	500	600	
	Max. number of grids/shelves	number	5	9	8	14
	Max. loading per grid/shelf	kg	20		30	
	Max. loading of chamber	kg	150	200		
	Max. loading per slide-in drip tray	kg	3	4	8	
	Max. loading per bottom drip tray	kg	3	4	8	
Textured stainless steel exterior	Width	(D) mm	745	824	1224	
	Height (with castors)	(E) mm	1233	1552	1467	1950
	Depth (without door handle, depth of handle +56 mm)	(F) mm	584	684	784	
Standard equipment	Stainless steel grids, electropolished	number	2			
	Standard works calibration certificate (measuring point chamber center)	°C	+10 and +37			
Temperature	Working temperature range (not suitable for long-term storing at sub-zero temperatures. During permanent operation, the inner glass door may ice over)	°C	-12 to +60			
	Setting temperature range	°C	-12 to +60			
	Setting accuracy	°C	0.1			
Further data	Electrical load at 230/115 V, 50/60 Hz	approx. W	1200			
Packing data	Net weight	approx. kg	113	157	217	249
	Gross weight (packed in carton)	approx. kg	141	214	282	319
	Width	approx. mm	880	930	1330	
	Height	approx. mm	1410	1760	1700	2150
	Depth	approx. mm	810	930	1050	
<b>Order No. Compressor-Cooled Incubators</b>			<b>ICP110</b>	<b>ICP260</b>	<b>ICP450</b>	<b>ICP750</b>

Options	110	260	450	750
Voltage 115 V, 50/60 Hz			X2	
Chamber modification for the application of reinforced perforated stainless steel shelves or stainless steel grids (bearing rails mounted in the working chamber) - includes replacement of standard grids by reinforced grids		-		K1
Interior socket, ampacity 230 V/2.2 A, can be switched off with the On/Off switch, cannot be switched individually, moisture tight IP68			R3	
Entry port, 23 mm clear diameter, for introducing connections at the side, can be closed by flap and silicone stopper, standard positions			F0 F1	F3
Entry port (silicone), 40 mm clear diameter, moisture tight, can be closed by silicone stopper, at the back (please state location)			F7	
4 - 20 mA current loop interface	4 - 20 mA current loop interface (-20 to +70 °C = 4 to 20 mA)		V3	
	Temperature of a Pt100 sensor positioned flexibly in chamber for external temperature monitoring (max. 3) - price per sensor (-20 to +70 °C = 4 - 20 mA)		V6	
Fan speed monitoring with switching off the heating and with alarm in case of failure			V4	
Works calibration certificate for 3 temperatures: 0, +37, +60 °C			D00130	
Works calibration certificate for one (freely selectable) temperature value according to customer specification			D00109	
Door with lock and key (safety lock)			B6	
Potential-free contact for combination error message (e.g. supply failure, sensor fault, fuse)			H6	
Door-open-recognition			V5	
MobileALERT, notification by SMS in case of any error or alarm of the device (requires option H6)			C3	

Accessories	110	260	450	750
Stainless steel grid, electropolished	E20165	E28891		E20182
Reinforced stainless steel grid, electropolished, max. loading 60 kg; from size 450 with guide bars and fixing screws (only in connection with option K1). Please consider max. loading of chamber	E29767	E29766		B32190
Perforated stainless steel shelf	B00325	B29725		B00328
Reinforced stainless steel shelf, max. loading 60 kg; with guide bars and fixing screws (requires option K1). Please consider max. loading of chamber		-		B32191
Stainless steel slide-in drip tray, 15 mm rim (may affect the temperature distribution, not in connection with option K1)	E02073	E29726		E02075
Stainless steel slide-in drip tray, 15 mm rim, with guide bars and fixing screws (may affect the temperature distribution, only in connection with option K1)		-		B32763
Stainless steel bottom drip tray, 15 mm rim (may affect the temperature distribution, not in connection with option K1)	B04359	B29722		B04362
Stainless steel bottom drip tray, 15 mm rim (may affect the temperature distribution, only in connection with option K1)		-		B34055
USB-Ethernet adapter			E06192	
Ethernet connection cable 5 m for computer interface			E06189	
USB User-ID stick (with User-ID licence): Oven-linked authorisation licence (User-ID-programme) on Memory-stick, prevents undesired manipulation by unauthorised third parties. When reordering please specify serial number			B33170	
FDA conforming software AtmoCONTROL (FDA edition). Meets the requirements for the use of electronically stored data sets and electronic signatures as laid down in Regulation 21 CFR Part 11 of the US Food and Drug Administration (FDA). Base licence for the control of one unit. Respective IQ/OQ documents available in German and English language (without surcharge)			FDAQ1	
Integration of additional units (up to max. 31 units) into an already existent FDA-software licence			FDAQ2	
DAkkS calibration for one free-selectable temperature value according to method C (DKD-R 5-7)			E39696	
DAkkS calibration for further temperature values according to method C (DKD-R 5-7)			E39697	
IQ document with device-specific works test data, OQ/PQ check list as support for validation by customer			D00124	
IQ/OQ document with device-specific works test data for one free-selectable temperature value, incl. temperature distribution survey at Memmert for 27 measuring points to DIN 12880:2007-05. PQ check list as support for validation by customer. 305 € for further temperature values			D00127	
On-site IQ/OQ for a freely selectable temperature value, including temperature distribution survey for 27 measuring points to DIN 12880: 2007-05 (excluding travel costs, not subject to discount, GER, AT, FR only)			DLQ100	
Extension of DLQ100 by an additional freely selectable temperature value (not subject to discount)			DLQ100A	
Individual on-site Performance Qualification (PQ)			DLQ200	
Maintenance ICP/ ICPEco - carrying out and documentation according to Memmert maintenance plan (excluding travel costs, not subject to discount, GER, AT, FR only)			S00315	
Maintenance contract ICP/ ICPEco - carrying out and documentation according to Memmert maintenance plan, minimum duration 3 years (excluding travel costs, not subject to discount, GER, AT, FR only)			S00315J	
Calibration of one freely selectable temperature value (excluding travel costs, not subject to discount, GER, AT, FR only)			S00205	
Calibration of an additional temperature value (not subject to discount)			S00215	



Peltier-cooled incubator IPPeeco  
with SingleDISPLAY  
Peltier-cooled incubator IPPeecoplus  
with TwinDISPLAY  
with Advanced Peltier Technology  
AtmoCONTROL software

Model sizes:

IPP: 30 / 55

IPPeeco: 110 / 260 / 410 / 750 / 1060

0 °C to +70 °C

Model sizes:

IPPeeco: 1400 / 2200

+15 °C to +60 °C

**PELTIER-COOLED INCUBATOR IPPeeco** Heating and cooling seamlessly with one system thanks to Peltier technology. In this respect, cooled incubators IPPeeco not only contribute to climate protection, but it also achieves an additional decrease in operating costs of up 90 % compared to compressor technology. This perfect development from the environmentally friendly and energy-saving heating/cooling technology by Memmert convinces by outstanding control precision and extremely small fluctuations.



## Smooth running

The fact that no compressor is required saves space and brings peace and quiet to the laboratory. As Peltier-cooled incubators IPPeco are almost vibration-free, they can also be applied in entomology. If defined humidity is also required, an alternative would be the constant climate chamber HPPeco, which is also equipped with the Advanced Peltier technology.

## No condensation in the interior chamber

Due to the closed Peltier cooling system, no outside air is exchanged. Physically derived, unavoidable formation of condensation during the cooling process does not take place in the interior chamber but on the outside heat sink. In addition, the in the Peltier elements integrated fans ensure a rapid transport of energy as well as an absolutely homogenous distribution of temperature.

Despite the significantly reduced energy consumption, the IPPeco's performance is impressive. Heating up, cooling down and recovering after opening the door occur fine-tuned and yet at top speed.

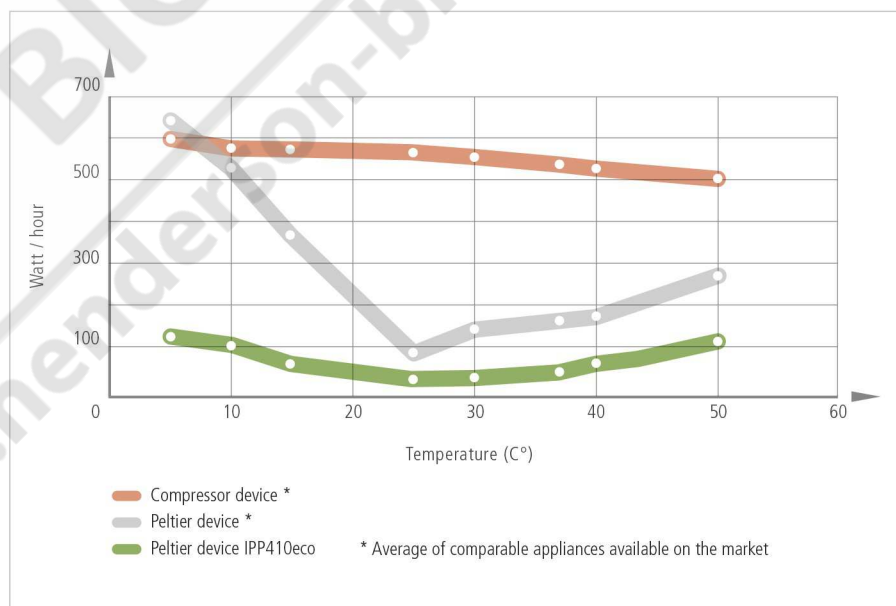

## PELTIER-COOLED INCUBATORS IPPeco

according to DIN 12880:2007-05, EN 61010-1 (IEC 61010-1), EN 61010-2-010

Standard units are safety-approved and bear the test marks:



**Interior:** Stainless steel, material 1.4301 (ASTM 304), deep-drawn

**Housing:** Textured stainless steel, rear zinc-plated steel, intuitively operated SingleDISPLAY or TwinDISPLAY (TFT colour display) with touchscreen

**Double doors:** Outside stainless steel, fully insulated, inside glass (size 1400/2200 stainless steel doors with glass sector, fully heated inner glass panes integrated in the full-sight glass door with 2-point locking – compression door lock). Sizes 750, 1060 and 1400 two leaves, size 2200 three leaves

**Connection:** Mains cable with plug (German type)

**Installation:** 4 feet; sizes 410, 750 and 1060 mounted on lockable castors, 1400 and 2200 mounted on height-adjustable and lockable castors

**Interfaces:**

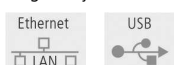

USB: only for TwinDISPLAY

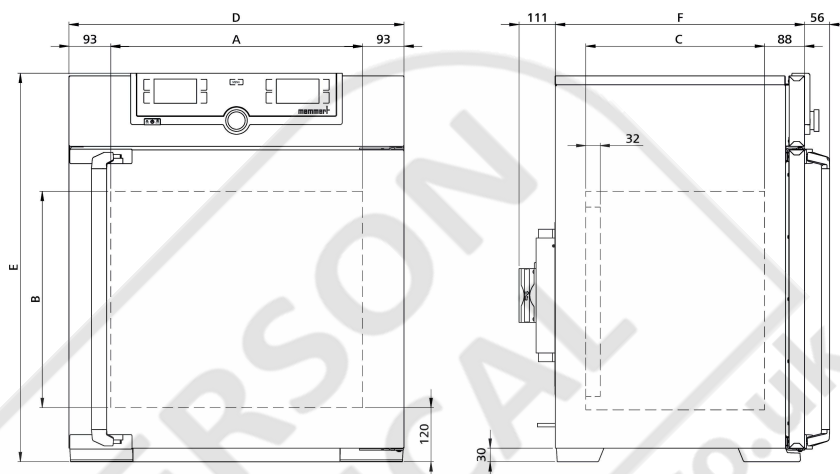

Model sizes/Description			30	55	110	260	410	750	1060	1400	2200		
Stainless steel interior	Volume	approx. l	32	53	108	256	384	749	1060	1360	2140		
	Width	(A) mm	400		560	640		1040		1250	1972		
	Height	(B) mm	320	400	480	800	1200		1450				
	Depth (less 10 mm (sizes 30 and 55), less 32 mm (sizes 110 to 2200) for fan – Peltier)	(C) mm	250	330	400	500		600	850	750			
	Max. number of grids/shelves	number	3	4	5	9	14		28		42		
	Max. loading per grid/shelf	kg				20	30		20		30		
	Max. loading of chamber	kg	60	80	150	200		250		330			
Max. loading per slide-in drip tray	kg	1,5		3	4		8		-				
Max. loading per bottom drip tray	kg	1,5		3	4		8		-				
Textured stainless steel exterior	Width	(D) mm	585		745	824		1224		1435	2157		
	Height (sizes 410, 750, 1060 with castors)	(E) mm	704	784	864	1183	1720		1913				
	Depth (without door handle, depth of handle +56 mm)	(F) mm	434	514	555	655		755	1005	905			
Standard equipment	Stainless steel grids, electropolished	number	1		2				4		6		
	Standard works calibration certificate (measuring point chamber center)	°C	+10 and +37						+25 and +40				
Temperature	Working temperature range without light	°C	0 (at least 20 below ambient temperature) to +70							+15 (at least 10 below ambient temperature) to +60			
	Working temperature range with light	°C	-		+10 to +40				-				
	Setting temperature range	°C	0 to +70							+15 to +60			
	Setting accuracy	°C	0.1										
Further data	Electrical load at 230 V, 50/60 Hz	approx. W	140	275	320	600		1200		1800			
	Electrical load at 115 V, 50/60 Hz	approx. W	140	275	320	600		1200		-			
	Peltier elements in the rear	number	1			2		4		6			
Packing data	Net weight	approx. kg	40	52	78	114	157	230	255	450	493		
	Gross weight (packed in carton)	approx. kg	56	71	103	165	210	301	419	639	730		
	Width	approx. mm	660	730	830	930		1330	1370	1560	2300		
	Height	approx. mm	890	950	1050	1380	1930	1910	1970	2200			
	Depth	approx. mm	650	670	800	930		1050	1300	1190			

### Order No. Peltier-Cooled Incubators

IPP = Peltier-Cooled Incubators

plus = Model with TwinDISPLAY

(IPP1400eco/ IPP1400ecoplus and IPP2200eco/ IPP2200ecoplus available from Q2 2021)

IPP30	IPP55	IPP110eco	IPP260eco	IPP410eco	IPP750eco	IPP1060eco	IPP1400eco	IPP2200eco
IPP30plus	IPP55plus	IPP110ecoplus	IPP260ecoplus	IPP410ecoplus	IPP750ecoplus	IPP1060ecoplus	IPP1400ecoplus	IPP2200ecoplus



Options	30	55	110	260	410	750	1060	1400	2200
Chamber modification for the application of reinforced perforated stainless steel shelves or stainless steel grids (bearing rails mounted in the working chamber) - includes replacement of standard grids by reinforced grids (standard with 1060)						K1		-	
Light module cold white 6,500 K: light strips arranged on the side walls of the interior, 10 strips for model 110, 14 for model 260/410/750, programme-controlled dimming from 0 to 100 % (in 1 % steps), ramp programming in combination with temperature (only with TwinDISPLAY; not in combination with F6, F7, D8)	-				T7			-	
Light module cold white 6,500 K + warm white 2,700 K: LED light strips - 10 strips for model 110, 14 for model 260/410/750 - (6 resp. 8 alternating cold white light strips and 4 resp. 6 warm white light strips) on the side walls of the interior, programme-controlled dimming from 0 to 100 % (in 1 % steps), ramp programming in combination with temperature (only with TwinDISPLAY; not in combination with F6, F7, D8)	-				T8			-	
Light module warm white 2,700 K: light strips arranged on the side walls of the interior, 10 strips for model 110, 14 for model 260/410/750, programme-controlled dimming from 0 to 100 % (in 1 % steps), ramp programming in combination with temperature (only with TwinDISPLAY; not in combination with F6, F7, D8)	-				T9			-	
Interior socket, ampacity 230 V/2.2 A, can be switched off with the On/Off switch, cannot be switched individually, moisture tight IP68					R3				-
Entry port, 23 mm clear diameter, for introducing connections at the side, can be closed by flap, standard positions (F0 and F2 not for model size 260 with light module; F0 - F3 not for model size 110 with light module)					left centre/centre	F0			-
					left centre/top	F1			-
					right centre/centre	F2			-
					right centre/top	F3			-
Entry port, 23 mm clear diameter, can be closed by flap (please state location)					left	F4			
					right	F5			
					rear	F6			-
Entry port, 38 mm clear diameter, can be closed by flap, in special positions in the back wall (please state location; not in combination with T7, T8, T9)						F7			-
Entry port (silicone), 40 mm clear diameter, moisture tight, can be closed by silicone stopper, standard position rear (not in combination with T7, T8, T9)									D8
4 - 20 mA current loop interface (-10 to +80 °C = 4 - 20 mA)									V3
Works calibration certificate for 3 temperatures: +5, +37, +60 °C						D00129			-
Works calibration certificate for one (freely selectable) temperature value according to customer specification									D00109
Door with lock and key (safety lock)						B6			-
						-		B62	-
						-			B63
Door hinged on the left				B8					-
Potential-free contact for combination error message (e.g. supply failure, sensor fault, fuse)						H6			
Process-dependent programmable door lock (only for units with TwinDISPLAY)						D4			-
						-		D42	-
						-			D43
Door-open-recognition (only for units with TwinDISPLAY)						V5			-
						-		V52	-
						-			V53
MobileALERT, notification by SMS in case of any error or alarm of the device (requires option H6)						C3			
Castor frame (2-part), height 140 mm				R9					-

Accessories	30	55	110	260	410	750	1060	1400	2200
Stainless steel grid, electropolished	E28884	E20164	E20165	E28891	E20182	B41251	B38955		
Reinforced stainless steel grid, electropolished, max. loading 60 kg; size 750 with guide bars and fixing screws (requires option K1). Please consider max. loading of chamber		-	E29767	E29766	B32190	B32550		-	
Perforated stainless steel shelf	B29727	B03916	B00325	B29725	B00328			-	
Reinforced stainless steel shelf, max. loading 60 kg; with guide bars and fixing screws (requires option K1). Please consider max. loading of chamber			-		B32191	B32549		-	
Stainless steel slide-in drip tray, 15 mm rim (may affect the temperature distribution, not in connection with option K1)	E02070	E02072	E02073	E29726	E02075	B32599		-	
Stainless steel slide-in drip tray, 15 mm rim, with guide bars and fixing screws (may affect the temperature distribution, only in connection with option K1)			-		B32763			-	
Stainless steel bottom drip tray, 15 mm rim (may affect the temperature distribution, not in connection with option K1)	B04356	B04358	B04359	B29722	B04362	B29769		-	
Stainless steel bottom drip tray, 15 mm rim (may affect the temperature distribution, only in connection with option K1)			-		B34055			-	

Accessories	30	55	110	260	410	750	1060	1400	2200
Guarantee extension by 1 year	GA1Q5			GA2Q5			GA4Q5		
USB-Ethernet adapter					E06192				
Ethernet connection cable 5 m for computer interface					E06189				
USB User-ID stick (with User-ID licence): Oven-linked authorisation licence (User-ID-programme) on Memory-stick, prevents undesired manipulation by unauthorised third parties. When reordering please specify serial number (only for units with TwinDISPLAY)					B33170				
USB stick with documentation software AtmoCONTROL and operation manual for products with SingleDISPLAY (the standard equipment of appliances with TwinDISPLAY includes one USB stick with AtmoCONTROL). When reordering please specify serial number					B33172				
Set of height adjustable feet (4 pcs)	B29768				-				
Stacking set (4 pcs) for stacking of appliances of same size	B29744				-				
Flush-fit unit (stainless steel frame covering gap between oven and wall opening), with air slots	B29728	B29730	B29734	B29738	B42116	B29742	-		
Flush-fit unit (stainless steel frame covering gap between oven and wall opening), without air slots	B29729	B29731	B29735	B29739	B42117	B29743	-		
Subframe, adjustable in height (size 30 and 55: height 600 mm, size 110 and 260: height 500 mm)	B29745	B29747	B29749	B29751	-				
Subframe, on castors (size 30 and 55: height 660 mm, size 110: height 560 mm)	B29746	B29748	B29750	-					
Subframe, adjustable in height, height 130 mm, for example for units with fresh air filter	B33657	B33659	B33661	B33664	-				
Software conforming to FDA AtmoCONTROL. Meets the requirements for the use of electronically stored data sets and electronic signatures as laid down in Regulation 21 CFR Part 11 of the US Food and Drug Administration (FDA). Base licence for the control of one unit (only for units with TwinDISPLAY). Respective IQ/OQ documents available in German and English language (without surcharge)					FDAQ1				
Integration of one additional unit (up to max. 31 units) into an already existent FDA-software licence (only for units with TwinDISPLAY)					FDAQ2				
External measuring instrument with sensors for daylight and UV-light. Product information on demand (models IPPecoplus/ IPPplus)				B04713			-		
External measuring instrument with additional measuring head for temperature and humidity measurement. Product information on demand (models IPPecoplus/ IPPplus)					B04714				
DAkkS calibration for one free-selectable temperature value according to method C (DKD-R 5-7)					E39696				
DAkkS calibration for further temperature values according to method C (DKD-R 5-7)					E39697				
IQ document with device-specific works test data, OQ/PQ check list as support for validation by customer					D00124				
IQ/OQ document with device-specific works test data for one free-selectable temperature value, incl. temperature distribution survey at Memmert for 9 measuring points (size 30), 27 measuring points (sizes 55 - 1060, 2200) and 26 measuring points (size 1400) according to DIN 12880:2007-05. PQ check list as support for validation by customer. 305 € for further temperature values	D00125		D00127						
On-site IQ/OQ for a freely selectable temperature value, including temperature distribution survey for 9 measuring points (size 30), 27 measuring points (sizes 55 - 1060, 2200) and 26 measuring points (size 1400) to DIN 12880: 2007-05 (excluding travel costs, not subject to discount, GER, AT, FR only)					DLQ100				
Extension of DLQ100 by an additional freely selectable temperature value (not subject to discount)					DLQ100A				
Individual on-site Performance Qualification (PQ)					DLQ200				
Maintenance IPP/ IPPeco - carrying out and documentation according to Memmert maintenance plan (excluding travel costs, not subject to discount, GER, AT, FR only)					S00317				
Maintenance contract IPP/ IPPeco - carrying out and documentation according to Memmert maintenance plan, minimum duration 3 years (excluding travel costs, not subject to discount, GER, AT, FR only)					S00317J				
Calibration of one freely selectable temperature value (excluding travel costs, not subject to discount, GER, AT, FR only)					S00205				
Calibration of an additional temperature value (not subject to discount)					S00215				

The image shows a large sheet of white paper with horizontal lines, intended for personal notes. A large, semi-transparent watermark is overlaid diagonally across the page. The watermark features a stylized 'C' logo on the left, composed of a red upper half and a blue lower half. To the right of the logo, the text 'HENDERSON BIOMEDICAL' is written in a large, bold, sans-serif font. Below this, the website address 'www.henderson-biomedical.co.uk' is written in a smaller font. In the bottom right corner, a woman with dark hair, wearing a red shirt, is peeking over the edge of the paper and pointing towards the watermark.

## MODEL VARIANTS

SingleDISPLAY ControlCOCKPIT with one TFT display	TwinDISPLAY ControlCOCKPIT with two TFT displays
<b>AVAILABLE APPLIANCES</b> UN / UF / IN / IF / IPPeco / IPP / UNm / UFm / INm / IFm / SN / SF / IFbw	<b>AVAILABLE APPLIANCES</b> HPPeco / ICHeco / ICH / HCP / UNplus / UFplus / UF TS / UNpa / VO / INplus / IFplus / ICO / IPPecoplus / IPPplus / ICPeco / ICP / UNmplus / UFmplus / INmplus / IFmplus / SNplus / SFplus / ICOfmed
One high-resolution TFT colour display with touch-sensitive buttons for selection of functions	Two high-resolution TFT colour displays with touch-sensitive buttons for selection of functions
Available parameters on the ControlCOCKPIT: Temperature (Celsius or Fahrenheit), fan speed, exhaust air flap position, programme time	Available parameters on the Control COCKPIT: All parameters of the SingleDISPLAY and device-specific parameters like relative humidity, illumination and CO <sub>2</sub>
One temperature sensor Pt100 DIN class A in a 4-wire circuit	Two Pt100 sensors DIN class A in a 4-wire circuit for mutual monitoring, taking over functions in case of an error
	HeatBALANCE function for application specific adjustment of heat output distribution (balance) between the upper and lower heating groups in an adjustment range between -50 % and +50 % (not valid for models 30, HPP110eco, IPP110ecoplus, ICPeco, ICP, ICHeco, ICH)
AtmoCONTROL software <sup>1)</sup> for reading out, managing and organising the data logger via Ethernet interface (temporary trial version can be downloaded). USB stick with AtmoCONTROL software available as accessory (on demand)	AtmoCONTROL software <sup>1)</sup> on a USB stick for programming, managing and transferring programmes via Ethernet interface or USB port
	ControlCOCKPIT with USB port for uploading programmes, reading out protocol logs, activating the User-ID function
	Displaying of already logged protocol data on the ControlCOCKPIT (max 10,000 values correspond to approx. 1 week)
Ethernet interface on the rear of the appliance for reading out the protocol log and for online logging	Ethernet interface on the rear of the appliance for reading out the protocol log and for uploading programmes and for online logging
Double overtemperature protection: Electronic temperature monitoring with freely adjustable monitoring temperature, for models U, I, S with option A6 TWW/TWB (protection class 3.1 or 2), mechanical temperature limiter TB acc. to DIN 12880	Multiple overtemperature protection: Electronic temperature monitoring TWW/TWB (protection class 3.1 or 2 resp. 3.3 for units with active cooling) and mechanical temperature limiter TB (protection class 1) acc. to DIN 12880, AutoSAFETY automatically adjusts to the set value within a freely adjustable tolerance range. Setting individual MIN / MAX values for over/undertemperature and also for all other parameters such as relative humidity, CO <sub>2</sub>
PID microprocessor control with integrated auto-diagnostic system	
Structured stainless steel housing, scratch-resistant, robust and durable; rear of zinc-plated steel	
High-temperature connectors on the rear of the appliance for single-phase power connection according to country specific systems and IEC standards	
Internal data logger with a storage capacity of at least 10 years	
German, English, French, Spanish, Polish, Czech, Hungarian language settings available on the ControlCOCKPIT	
Digital backwards counter with target time setting, adjustable from 1 minute to 99 days	
The SetpointWAIT function guarantees that the process time does not start until the set temperature is reached at all measuring points – optional for temperature values recorded by the freely positionable Pt100 sensors inside the chamber	
Adjustment of three calibration values for temperature and additional appliance specific parameters directly at the ControlCOCKPIT	

<sup>1)</sup> As a manufacturer, Memmert GmbH + Co. KG clearly labels its devices, which are medical devices in the sense of the European legislation. The AtmoCONTROL software is not a medical device. All Memmert medical devices can be used for their purpose without the software AtmoCONTROL. AtmoCONTROL is only intended for reading the data logging in conjunction with Memmert GmbH + Co. KG medical devices.

## SOFTWARE AtmoCONTROL

### AtmoCONTROL

The innovative control and logging software

Parameters such as temperature and humidity as well as the process time can be set directly at the ControlCOCKPIT. Ramp programming is done via the control and logging software AtmoCONTROL.

### Drag, drop & go!

Numerical and graphic programming of complex processes is a thing of the past. Today, programming is done via AtmoCONTROL by means of the mouse or touchpad on your notebook. Even the most complex ramp programmes are created within minutes. Simply drag & drop the graphical symbols for the desired parameters to the input field and change the values according to your wishes with a mouse click.

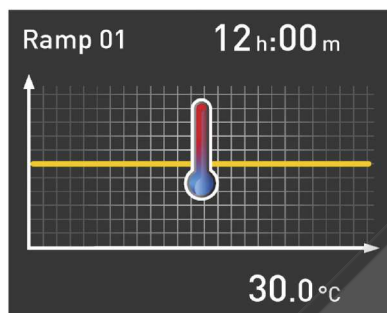

### Programme functions for appliances with SingleDISPLAY and TwinDISPLAY

- Reading out, managing and organising the data logger
- Saving the log memory in various formats
- Online monitoring of up to 32 connected appliances
- Optical alarms when the alarm limits individually set at the ControlCOCKPIT are exceeded
- Automatic alarm to one or several e-mail addresses

### Additional functions for appliances with TwinDISPLAY

- Intuitive programming and archiving of ramps and programme sequences
- Synchronous visualisation of the created programme sequence during programming
- Application-specific repeat functions (loops) can be inserted within a temperature control programme in any place
- Simple creation of repeating weekly programmes
- Programming, managing and transferring programmes via Ethernet interface or USB port

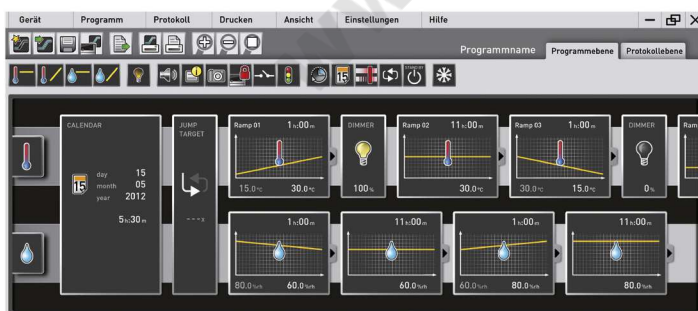

## Device Modifications - Proven and Good

### The perfect extension for your Memmert appliance

Our mission at Memmert is to provide you with the best possible solution for your individual application. With the increasing complexity of customer processes, a custom-fit modification of our appliances has many advantages for your application. Through modifications, process and set-up times can be significantly reduced or errors in the application can be completely ruled out by monitoring devices. Even small measures, such as individually adapted accessories, have a noticeable influence on the ergonomics and user-friendliness in the operation of the appliance.

You as a customer have the best ideas - and often already have a specific idea of how our products can be better used in your working environment.

Tell us about your thoughts and let us create an individual solution together with you! Please contact us and call us at +49 9122-925-0 or send us an email to [sonderbau@memmert.com](mailto:sonderbau@memmert.com).

The Memmert customisation department team is looking forward to hearing from you!

## Versatile modifications for our standard appliances



### Mechanics

- Customised interior fittings
- Individual entry ports in all sizes and shapes
- Telescopic slide pull-outs for ergonomic loading



### Electronics

- Extended parameter monitoring e.g. by means of additional measuring sensors
- Optical and acoustic process monitoring e.g. by means of a traffic light system



### Software

- Additional interfaces for data evaluation
- Individual temperature, humidity and CO<sub>2</sub> parameters



### Accessories

- Tailor-made subframe and stacking options
- Modified grids and shelves
- Individual air filters

## Customised solutions for your requirements

### Our expertise as a development partner in plant and project business

The Memmert customisation department has been active in the project business for over 20 years now and has proven itself in countless projects as a strong and reliable partner. The experts in customisation benefit from two aspects: Access to the complete capacities of an ultra-modern and specialised production line, as well as the entire technical know-how of the Memmert company in designing climate and temperature control appliances. Combined with the experience of our project managers, the Memmert customisation department is also able to find a solution for the most complex requirements.

### Special sizes

Does your product not fit into a standard unit? We build appliances to measure! Whether you need more volume in the interior or there is not enough space for installation at the installation location, we have the expertise to design your appliance individually. Ask us!

### Process and plant integration

Integrate our technology seamlessly into your plant or your work organisation. We will find the right solution together for your process integration:

- Preparation for integration into your plant
- Integration of your processes into our appliances
- Inclusion of customer-specific installations
- Interface for semi-automatic assembly

### Project business

Are you a project developer with ideas for innovative products and looking for a strategic cooperation? Take advantage of our know-how and manufacturing capacities for your project. Our customisation department will be pleased to hear from you!



www.henderson-biomedical

# memmert

## CLIMATE CHAMBERS

CONSTANT CLIMATE CHAMBERS HPPeco

HUMIDITY CHAMBERS HCP

CLIMATE CHAMBERS ICHeco / ICH

ENVIRONMENTAL TEST CHAMBERS CTC / TTC

## HEATING AND DRYING OVENS

UNIVERSAL OVENS U

PASS-THROUGH OVENS UFTS

PARAFFIN OVENS UNpa

VACUUM OVENS VO

## INCUBATORS

INCUBATORS I

CO<sub>2</sub> INCUBATORS ICO

COMPRESSOR-COOLED INCUBATORS ICPeco / ICP

PELTIER-COOLED INCUBATORS IPPeco

## MEDICAL DEVICES

UNIVERSAL OVENS Um

INCUBATORS Im

STERILISERS S

CO<sub>2</sub> INCUBATORS ICOmed

BLANKET WARMERS IFbw

## WATERBATHS

WATERBATHS WTB

YOUR MEMMERT PARTNER



Memmert GmbH + Co. KG  
P.O. Box 1720 | D-91107 Schwabach  
Tel. +49 9122 925-0 | Fax +49 9122 14585  
E-Mail: sales@memmert.com  
facebook.com/memmert.family  
instagram.com/memmert.family





**LABORATORY EQUIPMENT MAINTENANCE, REPAIR, CALIBRATION AND SALES**

Established in 1987, Henderson Biomedical is the UK's leading laboratory equipment sales and service provider. Our knowledgeable team can provide you with excellent sales advice on a range of different types of laboratory equipment including centrifuges, refrigerators, freezers and heat sealers.

Henderson Biomedical is also able to provide you with first class after-sales service and calibration of your laboratory equipment. We are an **ISO 17025 (UKAS) accredited calibration test laboratory** and our team of Field Service Engineers cover the whole of the United Kingdom.

Please contact us for more information on the types of equipment we supply and the different after-sales services we can offer.

**Henderson Biomedical**

Unit 3, Swan Close  
Croydon CR0 2DZ  
United Kingdom

**Tel: 020 8663 4610**

For sales enquiries: [sales@henderson-biomedical.co.uk](mailto:sales@henderson-biomedical.co.uk)  
For all other enquiries: [info@henderson-biomedical.co.uk](mailto:info@henderson-biomedical.co.uk)  
[www.henderson-biomedical.co.uk](http://www.henderson-biomedical.co.uk)

