

**memmert**

# Climate chambers

ALWAYS AN EYE ON LONG-TERM STABILITY.

CONSTANT CLIMATE CHAMBER HPPeco

HUMIDITY CHAMBER HCP

CLIMATE CHAMBER ICHeco/ICH

ENVIRONMENTAL TEST CHAMBER CTC/TTC

**MADE IN GERMANY.**

[www.memmert.com](http://www.memmert.com)



# Reliable. Precise.

Perfect simulation of reality.  
Reproducible, standard compliant, economic.

Each climate chamber creates a climate of temperature and humidity. For Memmert climate chambers, however, that is not enough. Each individual climate chamber is perfectly designed for the high requirements of stability and climate tests, conditioning or ageing. In each individual appliance, there is a homogenous and stable temperature and humidity distribution over the entire chamber. Operation, programming and documentation options feature top-notch convenience. Each individual Memmert climate chamber complies with the strict requirements of DIN 12880:2007-05 and is equipped with a maximum of safety functions.

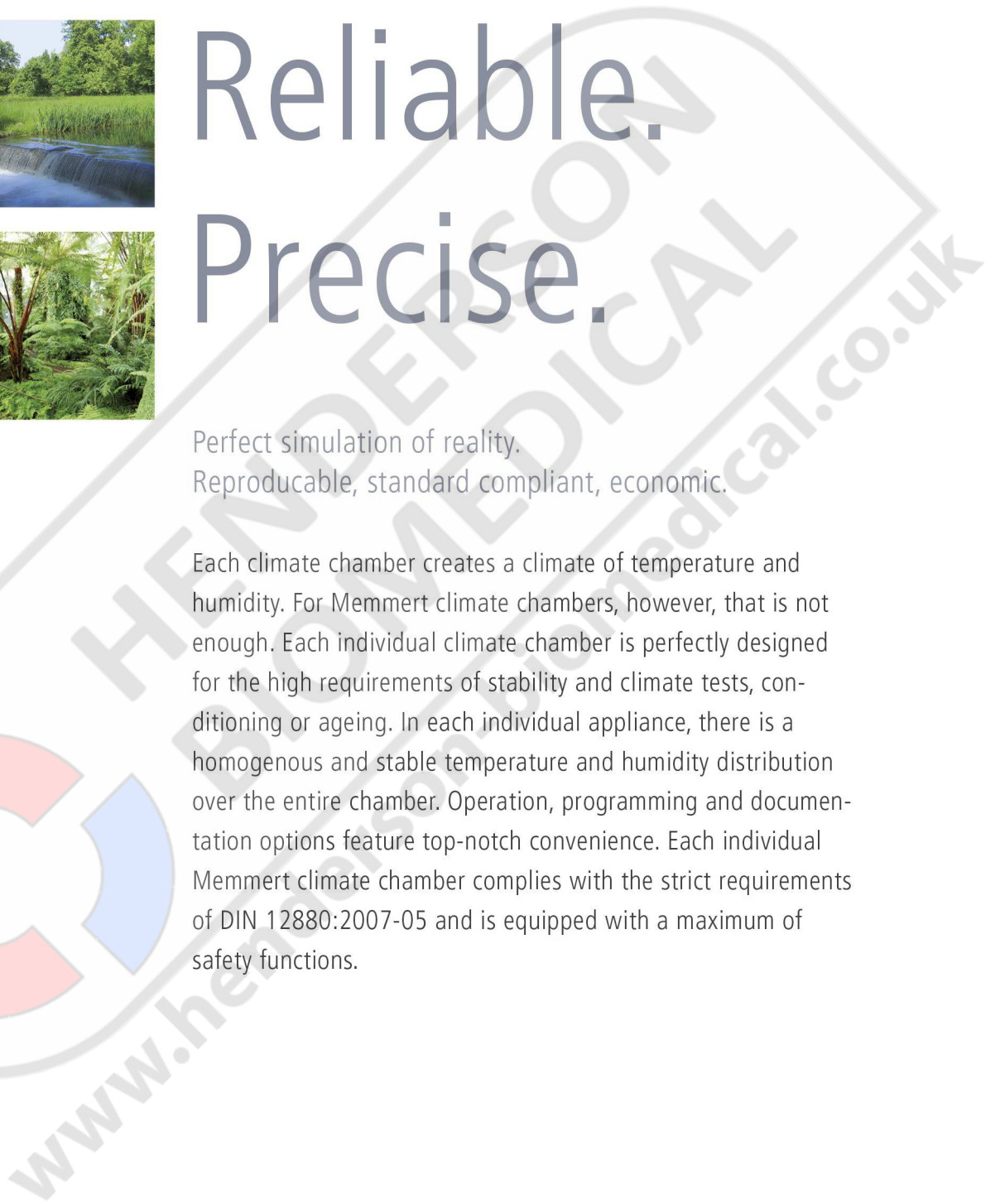

**CONSTANT CLIMATE CHAMBERS HPPeco****PAGE 4 - 8**

Stability testing (according to ICH Q1A) in the pharmaceutical industry, long-term storage, growing plants, conditioning and climate testing of plastic material/metal/composite material, storage of electronic components/lacquers/coatings in controlled environment

**HUMIDITY CHAMBERS HCP****PAGE 9 - 13**

Conditioning and climate testing of plastic material/metal/composite material, stability testings in the pharmaceutical industry, storage of electronic components/lacquers/coatings in controlled environment

**CLIMATE CHAMBERS ICHeco****PAGE 14 - 18**

Stability testing (according to ICH Q1A) and photostability testing (according to ICH Q1B) in the pharmaceutical industry, long-term storage, conditioning and climate testing of plastic material/metal/composite material, storage of electronic components/lacquers/coatings in controlled environment

**CLIMATE CHAMBERS ICH****PAGE 19 - 21**

Stability testing (according to ICH Q1A) and photostability testing (according to ICH Q1B) in the pharmaceutical industry, long-term storage, conditioning and climate testing of plastic material/metal/composite material, storage of electronic components/lacquers/coatings in controlled environment

**ENVIRONMENTAL TEST CHAMBERS CTC / TTC****PAGE 22 - 26**

Accelerated and intermediate tests, alternate stability testing, conditioning and climate-/ temperature testing of plastic material/metal/composite material, storage of electronic components/lacquers/coatings in controlled environment with/without humidity

**ADDITIONAL INFORMATION****PAGE 27**



Constant climate chamber HPPeco  
with Advanced Peltier Technology  
AtmoCONTROL software

Model sizes: 110 / 260 / 410 / 750 / 1060  
0 °C to +70 °C (without humidity)  
+5 °C to +70 °C (with humidity)  
Humidity 10 to 90 % rh  
optional with LED light module  
(sizes 110, 260, 410, 750)

Model sizes: 1400 / 2200  
+15 °C to +60 °C (with and without humidity)  
Humidity 10 to 80 % rh

**CONSTANT CLIMATE CHAMBER HPPeco** They are simply unbeatable in energy efficiency. Furthermore, as constant climate chambers HPPeco have a very long, almost maintenance free service life, they are perfectly suited for stability tests, storage in controlled environment and conditioning. The high precision temperature control as well as the active humidification and dehumidification were particularly adapted to the ICH guidelines, option Q1A, for stability tests.







**Homogenous and reliable, constant and reproducible**

An absolutely homogenous and stable distribution of temperature and humidity is guaranteed even when challenging parameters are given. The new Memmert microdosing pump and the smart control ensures a precise and quick humidification in the interior of the HPPeco.

### Advanced Peltier Technology

Thanks to the Advanced Peltier Technology, this constant climate chamber works around 90 % more energy efficiently than compressor-cooled devices. The main part of stability testing is performed at temperatures between +20 °C and +30 °C - close to the ambient temperature. The impressive cost effectiveness of the HPPeco with Advanced Peltier Technology can be seen here. Due to its environmentally friendly Peltier elements, the HPPeco has no need for refrigerants and requires no regular maintenance.

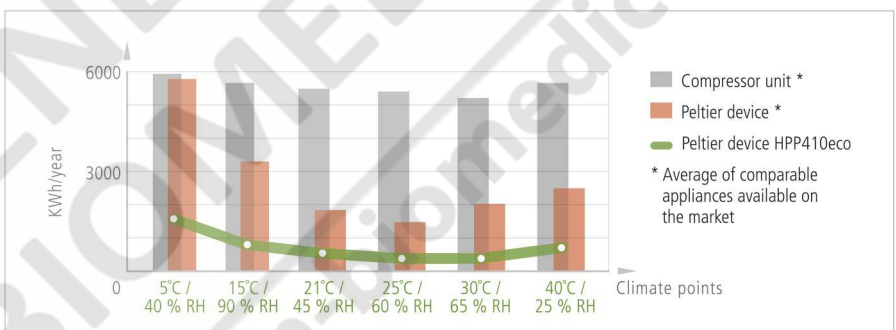

### LED light modules

Dimmable LED light protects the environment, reduces energy consumption and ensures ideal conditions of growth. Available alternatives: Cold-white light (6,500 K), warm-white light (2,700 K) or cold-white plus warm-white light, dimmable in 1 % steps, for HPP110eco – HPP750eco.

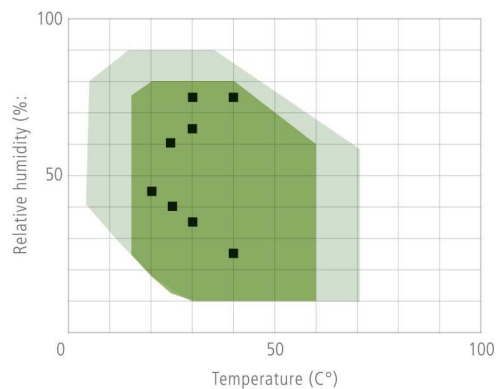

- ICH-compliant Q1A (R2) guideline climate testing points
- 110 to 1060
- 1400 to 2200

## CONSTANT CLIMATE CHAMBERS HPPeco

according to DIN 12880:2007-05, EN 61010-1 (IEC 61010-1), EN 61010-2-010

Standard units are safety-approved and bear the test marks:



- Interior:** Stainless steel, mat. 1.4301 (ASTM 304), deep-drawn
- Housing:** Textured stainless steel, rear zinc-plated steel, intuitively operated TwinDISPLAY (TFT colour display) with touchscreen
- Double doors:** Outside stainless steel, fully insulated, inside glass (size 1400/2200 stainless steel doors with glass sector, fully heated inner glass panes integrated in the full-sight glass door with 2-point locking – compression door lock). Sizes 750, 1060 and 1400 two leaves, size 2200 three leaves
- Connection:** Mains cable with plug (German type)
- Installation:** 4 feet; sizes 410, 750 and 1060 mounted on lockable castors, 1400 and 2200 mounted on height-adjustable and lockable castors
- Interfaces:**

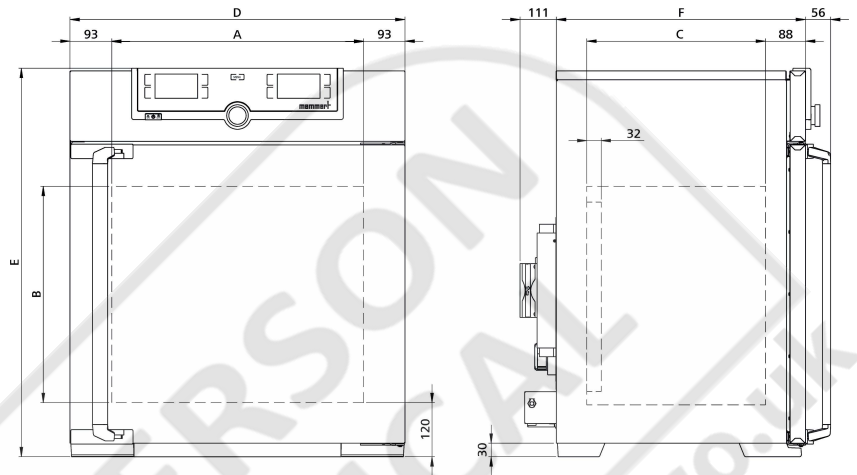
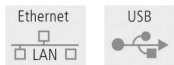

Model sizes/Description			110	260	410	750	1060	1400	2200	
Stainless steel interior	Volume	approx. l	108	256	384	749	1060	1360	2140	
	Width	(A) mm	560	640		1040		1250	1972	
	Height	(B) mm	480	800		1200		1450		
	Depth (less 32 mm for fan – Peltier)	(C) mm	400	500		600	850	750		
	Max. number of grids/shelves	number	5	9		14		28	42	
	Max. loading per grid/shelf	kg		20		30	20	30		
	Max. loading of chamber	kg	150		200			250	330	
	Max. loading per slide-in drip tray	kg	3	4		8		-		
	Max. loading per bottom drip tray	kg	3	4		8		-		
Textured stainless steel exterior	Width	(D) mm	745	824		1224		1435	2157	
	Height (sizes 410, 750, 1060, 1400 and 2200 with castors)	(E) mm	864	1183		1720		1913		
	Depth (without door handle, depth of handle +56 mm)	(F) mm	555	655		755	1005	905		
Standard equipment	Stainless steel grids, electropolished	number			2			4	6	
	Water tank including connection hose (sizes 110 - 750: 2.5 litres, sizes 1060/1400/2200: 10 litres)					●				
	Standard works calibration certificate (measuring point chamber center)				+10, 37 and 30 °C/60 % rh		+25 °C/40 % rh and +40 °C/75 % rh			
Temperature	Working temperature range without light, without humidity	°C	0 (at least 20 below ambient temperature) to +70					+15 (at least 10 below ambient temperature) to +60		
	Working temperature range without light, with humidity	°C	+5 (at least 20 below ambient temperature) to +70					+15 (at least 10 below ambient temperature) to +60		
	Working temperature range with light, without or with humidity	°C	+15 to +40					-		
	Setting temperature range without light, with humidity	°C	+5 to +70					+15 to +60		
	Setting temperature range with light, with humidity	°C	+5 to +70					-		
	Setting temperature range with light, without humidity	°C	0 to +70					-		
	Setting temperature range without light, without humidity	°C	0 to +70					+15 to +60		
Humidity	Setting range humidity with light	% rh	10 to 85					-		
	Setting range humidity without light	% rh	10 to 90					10 to 80		
	Setting accuracy	% rh	0.5							
Further data	Electrical load at 230 V, 50/60 Hz	approx. W	420	700			1400		2000	
	Electrical load at 115 V, 50/60 Hz	approx. W	420	700			1400		-	
	Peltier elements in the rear	number	1	2			4		6	
Packing data	Net weight	approx. kg	77	122	160	208	260	450	493	
	Gross weight (packed in carton)	approx. kg	102	173	213	279	424	639	730	
	Width	approx. mm	830	930		1330	1370	1560	2300	
	Height	approx. mm	1050	1380	1930	1910	1970	2200		
	Depth	approx. mm	800	930		1050	1300	1190		

**Order No. Constant Climate Chambers**

HPP110eco HPP260eco HPP410eco HPP750eco HPP1060eco HPP1400eco HPP2200eco

Options	110	260	410	750	1060	1400	2200
Chamber modification for the application of reinforced perforated stainless steel shelves or stainless steel grids (bearing rails mounted in the working chamber) - includes replacement of standard grids by reinforced grids (standard with 1060)		-		K1		-	
Light module cold white 6,500 K: LED light strips arranged on the side walls of the interior, 10 for model 110, 14 for model 260/410/750, programme controlled dimming from 0 to 100 % (in 1 % steps), ramp programming in combination with temperature and humidity; not in combination with F6, F7, D8			T7			-	
Light module cold white 6,500 K + warm white 2,700 K: LED light strips - 10 stripes for model 110, 14 for model 260/410/750 - (6 resp. 8 alternating cold white light strips and 4 resp. 6 warm white light strips) on the side walls of the interior, programme-controlled dimming from 0 to 100 % (in 1 % steps), ramp programming in combination with temperature and humidity; not in combination with F6, F7, D8			T8			-	
Light module warm white 2,700 K: light strips arranged on the side walls of the interior, 10 strips for model 110, 14 for model 260/410/750, programme-controlled dimming from 0 to 100 % (in 1 % steps), ramp programming in combination with temperature and humidity; not in combination with F6, F7, D8			T9			-	
Interior socket, ampacity 230 V/2.2 A, can be switched off with the On/Off switch, cannot be switched individually, moisture tight IP68			R3			-	
Entry port, 23 mm clear diameter, for introducing connections at the side, moisture tight, can be closed by flap and silicone stopper, standard positions (F0 and F2 not for model sizes 110 and 260 with light module; F0 - F3 not for model size 110 with light module)	left centre/centre left centre/top right centre/centre right centre/top		F0 F1 F2 F3			-	
Entry port, 23 mm clear diameter, moisture tight, can be closed by flap and silicone stopper, in special positions (please state location; not in combination with T7, T8, T9)	left right rear		F4 F5 F6			-	
Entry port (silicone), 40 mm clear diameter, moisture tight, can be closed by silicone stopper, at the back (please state location; not in combination with T7, T8, T9)			F7			-	
Entry port (silicone), 40 mm clear diameter, moisture tight, can be closed by silicone stopper, standard position rear (not in combination with T7, T8, T9)				D8			
4 - 20 mA current loop interface	Temperature controller actual value (-10 to +80 °C = 4 - 20 mA)			V3			
Works calibration certificate for one (freely selectable) temperature and humidity value				D00105			
Compressed air dehumidification (efficient dehumidification of the interior by means of compressed air). Standard works calibration certificate (measuring point chamber centre) at +10 °C with 10 % rh			C9			-	
Door with lock and key (safety lock)	One lock Two locks (one each door) Three locks (one each door)		B6 - -			B62 -	- - B63
Potential-free contact for combination error message (e.g. supply failure, sensor fault, fuse)				H6			
Process-dependent programmable door lock	One Two (one each door) Three (one each door)		D4 - -			D42 -	- - D43
Door-open-recognition	One Two (one each door) Three (one each door)		V5 - -			V52 -	- - V53
MobileALERT, notification by SMS in case of any error or alarm of the device (requires option H6)				C3			
MobileALERT for 2 alarm notifications; notification by SMS. temperature and humidity alarm				C4			
Castor frame (2-part), height 140 mm		R9				-	

Accessories	110	260	410	750	1060	1400	2200
Stainless steel grid, electropolished	E20165	E28891	E20182	B41251	B38955		
Reinforced stainless steel grid, electropolished, max. loading 60 kg; size 750 with guide bars and fixing screws (requires option K1). Please consider max. loading of chamber	E29767	E29766	B32190	B32550	-		
Perforated stainless steel shelf	B00325	B29725	B00328		-		
Reinforced stainless steel shelf, max. loading 60 kg; with guide bars and fixing screws (requires option K1). Please consider max. loading of chamber			B32191	B32549	-		
Stainless steel slide-in drip tray, 15 mm rim (may affect the temperature distribution, not in connection with option K1)	E02073	E29726	E02075	B32599	-		
Stainless steel slide-in drip tray, 15 mm rim, with guide bars and fixing screws (may affect the temperature distribution, only in connection with option K1)			B32763		-		
Stainless steel bottom drip tray, 15 mm rim (may affect the temperature distribution, not in connection with option K1)	B04359	B29722	B04362	B29769	-		
Stainless steel bottom drip tray, 15 mm rim (may affect the temperature distribution, only in connection with option K1)			B34055		-		

Accessories	110	260	410	750	1060	1400	2200
Holder for water tank (sizes 110 - 750: 2.5 litres, sizes 1060/1400/2200: 10 litres) for mounting on the rear of the appliance. Standard equipment for sizes 410, 750, 1060, 1400 and 2200	B49092		-				
Central water supply with filter cartridges for connection to the domestic water supply. Product information on demand				ZWVR6			
Central water supply without filter cartridges for connection to the domestic water supply (only for demineralised water with a conductivity of 5 to 10 µS/cm and a pH value between 5 and 7). Product information on demand				ZWVR7			
Guarantee extension by 1 year	GA2Q5	GA3Q5		GA4Q5			
USB-Ethernet adapter				E06192			
Ethernet connection cable 5 m for computer interface				E06189			
USB User-ID stick (with User-ID licence): Oven-linked authorisation licence (User-ID-programme) on Memory-stick, prevents undesired manipulation by unauthorised third parties. When reordering please specify serial number				B33170			
Set of height adjustable feet (4 pcs)	B29768		-				
Stacking set (4 pcs) for stacking of appliances of same size	B29744						
Flush-fit unit (stainless steel frame covering gap between oven and wall opening), with air slots	B29734	B29738	B42116	B29742	-		
Flush-fit unit (stainless steel frame covering gap between oven and wall opening), without air slots	B29735	B29739	B42117	B29743	-		
Subframe, adjustable in height (height 500 mm)	B29749	B29751	-				
Subframe, on castors (height 560 mm)	B29750	-					
Subframe, adjustable in height, height 130 mm, for example for units with fresh air filter	B33661	B33664	-				
FDA conforming software AtmoCONTROL (FDA edition). Meets the requirements for the use of electronically stored data sets and electronic signatures as laid down in Regulation 21 CFR Part 11 of the US Food and Drug Administration (FDA). Base licence for the control of one unit. Respective IQ/OQ documents available in German and English language (without surcharge)				FDAQ1			
Integration of additional units (up to max. 31 units) into an already existent FDA-software licence				FDAQ2			
External measuring instrument with sensors for daylight and UV-light. Product information on demand	B04713		-				
External measuring instrument with additional measuring head for temperature and humidity measurement. Product information on demand				B04714			
DAkkS calibration for one (freely selectable) temperature and humidity value according to method C (DKD-R 5-7)				E48847			
DAkkS calibration for further temperature and humidity values according to method C (DKD-R 5-7)				E48848			
IQ document with device-specific works test data, OQ/PQ check list as support for validation by customer				D00124			
IQ/OQ document with device-specific works test data for one free-selectable temperature value, incl. temperature distribution survey at Memmert for 27 measuring points (sizes 110 - 1060, 2200) and 26 measuring points (size 1400) to DIN 12880:2007-05. PQ check list as support for validation by customer. 305 € for further temperature values				D00127			
IQ/OQ document with device-specific works test data for one free-selectable temperature and humidity value, incl. temperature distribution survey at Memmert for 27 measuring points (sizes 110 - 1060, 2200) and 26 measuring points (size 1400) to DIN 12880:2007-05, PQ check list as support for validation by customer. 475 € for further temperature and humidity values				D00136			
IQ/OQ document with device-specific works test data for one free-selectable temperature and humidity value, and measuring of light intensity, incl. temperature distribution survey at Memmert for 27 measuring points to DIN 12880:2007-05, PQ check list as support for validation by customer. 605 € for further temperature and humidity values, and measuring of light intensity	D00137		-				
On-site IQ/OQ for a freely selectable temperature and humidity value, including temperature distribution survey for 27 measuring points (sizes 110 - 1060, 2200) and 26 measuring points (size 1400) to DIN 12880: 2007-05 (excluding travel costs, not subject to discount, GER, AT, FR only)				DLQ101			
Extension of DLQ101 by an additional freely selectable temperature and humidity value (not subject to discount)				DLQ101A			
Individual on-site Performance Qualification (PQ)				DLQ200			
Maintenance HPPeco - carrying out and documentation according to Memmert maintenance plan (excluding travel costs, not subject to discount, GER, AT, FR only)				S00314			
Maintenance contract HPPeco - carrying out and documentation according to Memmert maintenance plan, minimum duration 3 years (excluding travel costs, not subject to discount, GER, AT, FR only)				S00314J			
Calibration of one freely selectable temperature value (excluding travel costs, not subject to discount, GER, AT, FR only)				S00205			
Calibration of an additional temperature value (not subject to discount)				S00215			
Calibration of one freely selectable temperature and humidity value (excluding travel costs, not subject to discount, GER, AT, FR only)				S00207			
Calibration of an additional temperature and humidity value (not subject to discount)				S00216			



PERSONAL NOTES

Lined writing area for personal notes.

HENDERSON  
BIOMEDICAL  
www.henderson-biomedical.co.uk





Humidity chamber HCP  
with TwinDISPLAY  
AtmoCONTROL software

Model sizes: 50 / 105 / 150 / 240  
+18 °C to +90 °C  
Humidity 20 to 95% rh

**HUMIDITY CHAMBER HCP** with active humidity control from 20 % to 95 % rh and unsurpassed real temperature-humidity homogeneity over the entire interior, this nearly condensation-free climate chamber offers the full range of comfort, reliability and safety. It is ideally suited for environmental tests, accelerated life tests, stress tests of drug substance according to ICH Q1A and 85/85 tests to IEC 60068-2-67 and IEC 60068-2-78. It is also used in building physics and biological research.





## Optimum homogeneity of humidity and temperature

Active humidity control guarantees ideal homogeneity of temperature and humidity as well as short recovery times after opening the door. In addition, in combination with heating on all six sides, including the heated inner glass door, it minimises vaporisation in the interior and thus the risk of condensed water dripping onto the test object. An aluminium thermal conduction layer supports the optimal temperature distribution and serves as a heat accumulator if there is a temporary power failure.

## Comfortable equipment for accelerated service life tests

Service life tests such as 85/85 tests run over 1,000 hours and more. The humidity chamber HCP offers a wide range of comfort functions: Standard entry ports at the back, battery-buffered ControlCOCKPIT (option), with SetpointWAIT function process time does not start until the set temperature is reached, alarm messages can be sent via e-mail or SMS (option) and much more.

## Ramp programming

Essential for the exact simulation of environmental conditions in research: intuitive and fast ramp programming. Thanks to the AtmoCONTROL software, different set values of temperature and humidity can be combined on time ramps.

Ramp programming

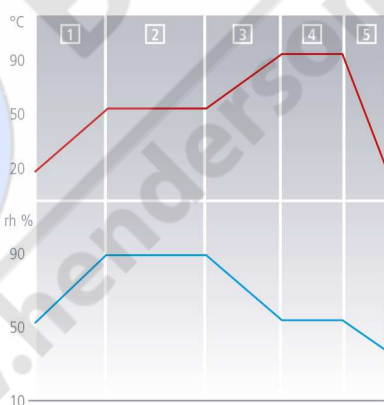



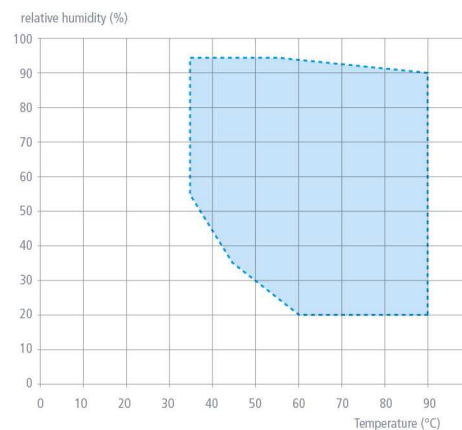

Temperature-humidity working range



Note: Within the respective temperature-humidity range, permanent operation is possible (at an ambient temperature of  $22\text{ °C} \pm 3\text{ K}$ ; relative humidity  $< 50\%$ ). Condensation may occur in the threshold range. To which extent depends on the humidity content of the chamber load and the ambient conditions.

## HUMIDITY CHAMBERS HCP

according to DIN 12880:2007-05, EN 61010-1 (IEC 61010-1), EN 61010-2-010

Standard units are safety-approved and bear the test marks:     

Interior: Stainless steel, material 1.4301 (ASTM 304), deep-drawn, seamlessly welded

Housing: Textured stainless steel, rear zinc-plated steel, intuitively operated TwinDISPLAY (TFT colour display) with touchscreen; fully insulated stainless steel door and heated inner glass door

Connection: Mains cable with plug (German type)

Installation: 4 adjustable feet

Interfaces:

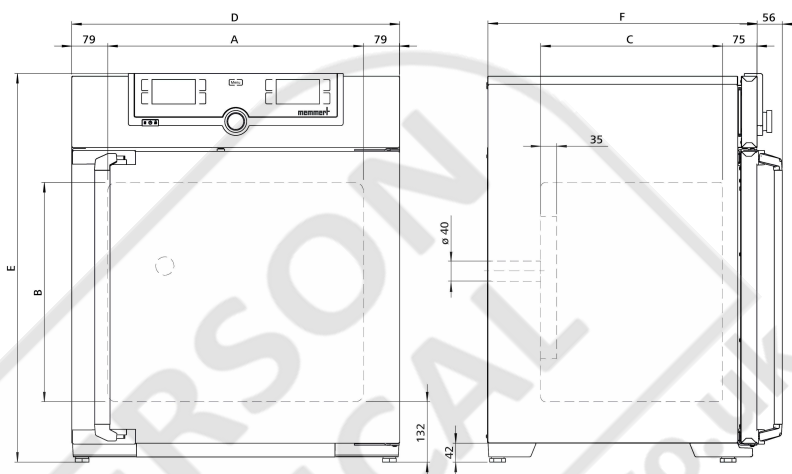
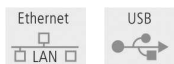

Model sizes/Description			50	105	150	240
Stainless steel interior	Volume	approx. l	56	107	156	241
	Width	(A) mm	400	560	600	600
	Height	(B) mm	425	480	700	810
	Depth (less 35 mm for fan)	(C) mm	330	400	500	500
	Max. number of grids/shelves	number	5	6	10	12
	Max. loading per grid/shelf	kg	15			
	Max. loading of chamber	kg	75	90	120	140
Textured stainless steel exterior	Width	(D) mm	559	719	759	759
	Height (variable through adjustable feet)	(E) mm	795	850	1070	1180
	Depth (without door handle, depth of handle +56 mm)	(F) mm	521	591	691	691
	Fully insulated heated stainless steel door			●		
	Additional heated inner glass door			●		
Standard equipment	Stainless steel shelves, perforated	number	1	2		
	Entry port (silicone), 40 mm clear diameter, moisture tight, can be closed by silicone stopper, at the back, centre left			●		
	Door-open-recognition incl. alarm, shuts down fan			●		
	Standard works calibration certificate (measuring point chamber center)			+60 °C with 75 % rh		
Temperature	Working temperature range	°C	at least 7 above ambient temperature up to +90			
	Setting temperature range	°C	+18 to +90			
	Setting accuracy	°C	0.1			
Humidity	Capacitive humidity sensor for measuring and displaying the relative humidity			●		
	Active microprocessor control for humidifying and dehumidifying (20 – 95 % rh), incl. digital indication and auto-diagnostic system ensures even more rapid reaching of set humidity and very short recovery times. Humidity supply with water (only for demineralised water with a conductivity of 5 to 10 µS/cm and a pH value between 5 and 7; from an external tank) by a self-priming pump; integral bacteria block by generating hot steam, dehumidifying via sterile filter				●	
	Setting range active humidity control	% rh	20 to 95 and rh-Off			
	Setting accuracy	% rh	0.5			
Further data	Electrical load at 230/115 V, 50/60 Hz	approx. W	1520	1720	1800	1840
Packing data	Net weight	approx. kg	55	75	90	110
	Gross weight (packed in carton)	approx. kg	74	100	116	145
	Width	approx. mm	730	800	840	840
	Height	approx. mm	950	1030	1250	1360
	Depth	approx. mm	640	800	900	900
<b>Order No. Humidity Chambers</b>			<b>HCP50</b>	<b>HCP105</b>	<b>HCP150</b>	<b>HCP240</b>



Options	50	105	150	240
Voltage 115 V, 50/60 Hz			X2	
Battery-buffered ControlCOCKPIT: uninterrupted supply for the entire display unit (ControlCOCKPIT) and therefore complete documentation of all parameters even when there is a power failure			C2	
Entry port, 23 mm clear diameter, at the side		left centre/top	F1	
		right centre/top	F3	
4 - 20 mA current loop interface	Temperature controller, actual value (0 to +100 °C = 4 - 20 mA) Humidity controller, actual value (0 to 100 % rh = 4 - 20 mA)		V3	
			V7	
Works calibration certificate for one (freely selectable) temperature and humidity value according to customer specification			D00105	
Potential-free contact for combination error message (e.g. supply failure, sensor fault, fuse)			H6	
MobileALERT, notification by SMS in case of any error or alarm of the device (requires option H6)			C3	
MobileALERT for 2 alarm notifications; notification by SMS. temperature and humidity alarm			C4	
Door with lock and key (safety lock)			B6	

Accessories	50	105	150	240
Perforated stainless steel shelf	E35160	E37418	E35158	
Stainless steel grid, electropolished	E20164	E20165	E43118	
Subframe (622 mm high) adjustable in height (sizes 150/240: should not be used for 2 stacked units)	B33504	B33505	B33506	
Subframe (130 mm high); sizes 150/240: only in combination with the corresponding stacking sets for stacked appliances	B33507	B33508	B33509	
Subframe, on castors (height 120 mm; stainless steel, material 1.4301)		-	B43598	
Central water supply with filter cartridges for connection to the domestic water supply. Product information on demand		ZWVR6		
Central water supply without filter cartridges for connection to the domestic water supply (only for demineralised water with a conductivity of 5 to 10 µS/cm and a pH value between 5 and 7). Product information on demand		ZWVR7		
Guarantee extension by 1 year		GA3Q5		
USB-Ethernet adapter		E06192		
Ethernet connection cable 5 m for computer interface		E06189		
USB User-ID stick (with User-ID licence): Oven-linked authorisation licence (User-ID-programme) on Memory-stick, prevents undesired manipulation by unauthorised third parties. When reordering please specify serial number		B33170		
Stacking set (4 pcs) for stacking of appliances of same size	B29744		-	
Stacking set (consisting of stacking corners, one connecting plate for the rear, two wall brackets) for stacking of two units of same size	-	B42114	-	
Stacking set (consisting of stacking corners, one connecting plate for the rear, two wall brackets) for stacking of two units of same size (only in connection with subframe B33509 or B43598)		-	B48129	
FDA conforming software AtmoCONTROL (FDA edition). Meets the requirements for the use of electronically stored data sets and electronic signatures as laid down in Regulation 21 CFR Part 11 of the US Food and Drug Administration (FDA). Base licence for the control of one unit. Respective IQ/OQ documents available in German and English language (without surcharge)		FDAQ1		
Integration of additional units (up to max. 31 units) into an already existent FDA-software licence		FDAQ2		
External measuring instrument with additional measuring head for temperature and humidity measurement. Product information on demand		B04714		
DAkkS calibration for one (freely selectable) temperature and humidity value according to method C (DKD-R 5-7)		E48847		
DAkkS calibration for further temperature and humidity values according to method C (DKD-R 5-7)		E48848		
IQ document with device-specific works test data, OQ/PQ check list as support for validation by customer		D00124		
IQ/OQ document with device-specific works test data for one free-selectable temperature and humidity value, incl. temperature distribution survey at Memmert for 27 measuring points to DIN 12880:2007-05, PQ check list as support for validation by customer. 475 € for further temperature and humidity values		D00136		
On-site IQ/OQ for a freely selectable temperature and humidity value, including temperature distribution survey for 27 measuring points to DIN 12880: 2007-05 (excluding travel costs, not subject to discount, GER, AT, FR only)		DLQ101		
Extension of DLQ101 by an additional freely selectable temperature and humidity value (not subject to discount)		DLQ101A		
Individual on-site Performance Qualification (PQ)		DLQ200		
Maintenance HCP - carrying out and documentation according to Memmert maintenance plan (excluding travel costs, not subject to discount, GER, AT, FR only)		S00313		
Maintenance contract HCP - carrying out and documentation according to Memmert maintenance plan, minimum duration 3 years (excluding travel costs, not subject to discount, GER, AT, FR only)		S00313J		
Calibration of one freely selectable temperature value (excluding travel costs, not subject to discount, GER, AT, FR only)		S00205		
Calibration of an additional temperature value (not subject to discount)		S00215		
Calibration of one freely selectable temperature and humidity value (excluding travel costs, not subject to discount, GER, AT, FR only)		S00207		
Calibration of an additional temperature and humidity value (not subject to discount)		S00216		



CO<sub>2</sub>-cooled climate chamber ICHeco  
with TwinDISPLAY + AtmoCONTROL software

Model sizes: 110 / 260 / 750

ICHeco / ICH with humidity control  
ICHeco L / ICH L with humidity control and light  
ICH C with humidity and CO<sub>2</sub> control

Temperature range with humidity

ICHeco / ICH +10 °C to +60 °C

ICHeco L / ICH L +10 °C to +60 °C

ICH C +10 °C to +50 °C

Humidity range 10 to 80 % rh

Temperature range without humidity

ICHeco / ICH -10 °C to +60 °C

ICHeco L / ICH L 0 °C to +60 °C

ICH C +10 °C to +50 °C

**CLIMATE CHAMBER ICHeco** These environmentally-friendly stability testing chambers operate with climate-friendly CO<sub>2</sub> (R744) as refrigerant. Powerful and climate-friendly at the same time, they are especially designed for testing pharmaceuticals according to ICH, Q1A and Q1B (option 2) as well as for testing the stability of cosmetics and foodstuffs. Temperature and humidity are distributed homogeneously and stable throughout the interior.



## Refrigerant CO<sub>2</sub> is climate-friendly

The decision for a CO<sub>2</sub>-cooled climate chamber ICHeco makes sense. The refrigerant CO<sub>2</sub> (R744) is almost climate-neutral in contrast to refrigerants with fluorinated greenhouse gases (e.g. R134a). Legal restrictions for use are therefore completely excluded in the future. R744 is neither flammable nor toxic and does not cause ozone depletion in the atmosphere.



## Refrigerant CO<sub>2</sub> ensures better cooling performance

An ICHeco is virtually maintenance-free and extremely powerful. Compared to appliances with refrigerant R134a, it scores with faster cooling-down times. The Memmert climate chambers ICH with refrigerant R134a will be available in parallel.



## All-round protection of samples

No icing, no drying out of samples, no dehumidification of the working chamber. Cooling aggregate and heating of the ICHeco/ICH are situated outside the working chamber in the air jacket surrounding the entire chamber thus ensuring quick and precise temperature control. Furthermore, the motor-driven forced air circulation, adjustable in 10 % steps, ensures particularly homogenous temperature distribution.

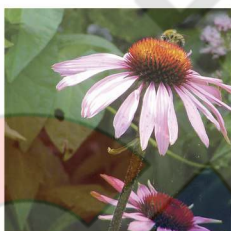

### Optionally with illumination unit (ICHeco L / ICH L) or CO<sub>2</sub> control (ICH C)

For tests according to ICH Q1B, option 2, an illumination unit with standard light D65 is available if required. The light sources are fluorescent lamps with cold white light (daylight: light colour 865, 6,500 K) and UV lamps in the spectral range 320 - 400 nm. Especially for tests in the construction industry model ICH C is available with a digitised, electronic CO<sub>2</sub> control with automatic zero setting, NDIR measuring method, self-diagnosis system, acoustic error display and air pressure compensation.

### Temperature-humidity working range

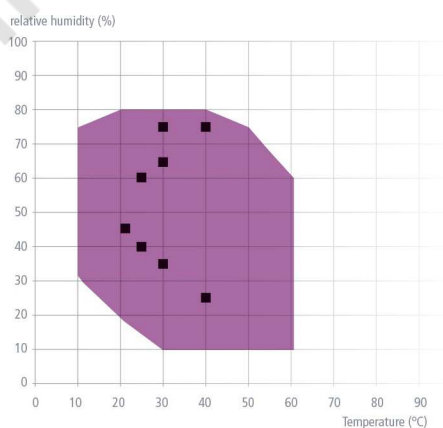

#### Note:

Within the respective temperature-humidity range, condensation-free permanent operation is possible. To which extent condensation may occur in the threshold range depends on the humidity content of the chamber load and the ambient conditions.

- Temperature and humidity test points defined in the ICH guideline

## CLIMATE CHAMBERS ICHeco

according to DIN 12880:2007-05, EN 61010-1 (IEC 61010-1), EN 61010-2-010

Standard units are safety-approved and bear the test marks:



- Interior: Stainless steel, mat. 1.4301 (ASTM 304), deep-drawn
- Housing: Textured stainless steel, rear zinc-plated steel, intuitively operated TwinDISPLAY (TFT colour display) with touchscreen
- Double doors: Outside stainless steel, fully insulated, inside glass (size 750: two leaves)
- Connection: Mains cable with plug (German type)
- Installation: Mounted on lockable castors
- Interfaces:

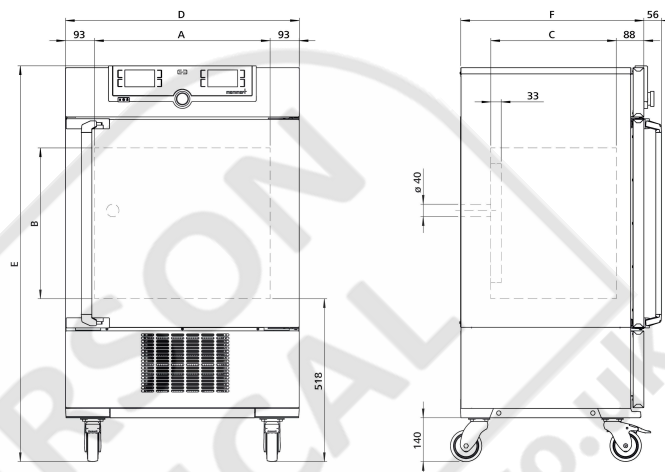

Model sizes/Description			110	260	750
Stainless steel interior	Volume	approx. l	108	256	749
	Width	(A) mm	560	640	1040
	Height	(B) mm	480	800	1200
	Depth (less 33 mm for fan)	(C) mm	400	500	600
	Max. number of grids/shelves	number	5	9	14
	Max. loading per grid/shelf	kg	20		30
	Max. loading of chamber	kg	150	200	
	Max. loading per slide-in drip tray	kg	3	4	8
Textured stainless steel exterior	Max. loading per bottom drip tray	kg	3	4	8
	Width	(D) mm	745	824	1224
	Height (with castors)	(E) mm	1233	1552	1950
	Depth (without door handle, depth of handle +56 mm)	(F) mm	585	685	785
Standard equipment	Stainless steel grids, electropolished	number	2		
	Entry port (silicone), 40 mm clear diameter, moisture tight, can be closed by a silicone stopper, standard position at the back		●		
	Water tank including connection hose		●		
	Standard works calibration certificate (measuring point chamber center)		+10, +37 and +30 °C with 60 % rh		
Temperature	Working temperature range without humidity ICHeco (not suitable for long-term storing at sub-zero temperatures. During permanent operation, the glass door may ice over)	°C	-10 to +60		
	Working temperature range ICHeco /ICHeco L with humidity and/or light	°C	+10 to +60		
	Working temperature range ICHeco L without humidity	°C	0 to +60		
	Setting temperature range ICHeco	°C	-10 to +60		
	Setting temperature range ICHeco L	°C	0 to +60		
Humidity	Setting accuracy	°C	0.1		
	Setting range humidity	% rh	10 to 80		
	Setting accuracy	% rh	0.5		
Light	Illumination unit (only ICHeco L) acc. ICH Q1B, option 2; separately switchable via controller, one box; Number of fluorescent lights with cold white light (size 110: 3, size 260/750: 4), light colour 865 6,500 K; Number of fluorescent lights with UV lamps (all sizes: 2), spectral range from 320 to 400 nm; (daylight and UV light comply with standard illuminant D65)		●		
Further data	Electrical load at 230 V, 50 Hz ICHeco	approx. W	1350		
	Electrical load at 230 V, 50 Hz ICHeco L	approx. W	1450	1550	
Packing data	Net weight	approx. kg	114	165	254
	Gross weight (packed in carton)	approx. kg	142	222	324
	Width	approx. mm	880	930	1330
	Height	approx. mm	1410	1760	2150
	Depth	approx. mm	810	930	1050
<b>Order No. Climate Chambers</b>			ICH110eco	ICH260eco	ICH750eco
ICHeco = Climate chamber			ICH110Leco	ICH260Leco	ICH750Leco
ICHeco L = Climate chamber with light					



Options	110	260	750
Chamber modification for the application of reinforced perforated stainless steel shelves or stainless steel grids (bearing rails mounted in the working chamber) - includes replacement of standard grids by reinforced grids (ICHeco/ICH and ICH C only)	-	-	K1
Illumination unit (has to be ordered together with the chamber) consisting of 4 fluorescent lights with cold white light (daylight: light colour 865, 6,500 K) and 2 UV lamps in the spectral range of 320 to 400 nm, acc. ICH Q1B, option 2 (daylight and UV light comply with standard illuminant D65) separately switchable via controller (only ICHeco L/ICH L)	second box	-	T72
Alternative light boxes (replace the standard lighting; have to be ordered together with the chamber); number of fluorescent lamps: size 110: 5, sizes 260/750: 6, with cold white light (daylight: light colour 865, 6.500 K; daylight complies with standard illuminant D65) (only ICHeco L/ICH L)	one box second box (cannot be switched on separately)	-	T81 T82
Alternative light boxes (replace the standard lighting; have to be ordered together with the chamber); number of fluorescent UV lamps: size 110: 5, sizes 260/750: 6, in the spectral range of 320 to 400 nm; UV light complies with standard illuminant D65 (only ICHeco L/ICH L)	one box second box (cannot be switched on separately)	-	T01 T02
Interior socket, ampacity 230 V/2.2 A, can be switched off with the On/Off switch, cannot be switched individually, moisture tight IP68 (not for ICH110eco L/ICH110L)			R3
Entry port, 23 mm clear diameter, for introducing connections at the side, moisture tight, can be closed by flap and silicone stopper, standard positions (F1 and F3 not for models ICHeco L/ICH L)	left centre/centre left centre/top right centre/top		F0 F1 F3
Entry port (silicone), 40 mm clear diameter, moisture tight, can be closed by silicone stopper, at the back (please state location). Not for models ICHeco L/ICH L			F7
4 - 20 mA current loop interface	Temperature controller actual value (-20 to +70 °C = 4 - 20 mA) Temperature of a Pt100 sensor positioned flexibly in chamber for external temperature monitoring (max. 3) - price per sensor (-20 to +70 °C = 4 - 20 mA) Humidity controller, actual value (0 to 100 % rh = 4 - 20 mA)		V3 V6 V7
Fan speed monitoring with switching off the heating and with alarm in case of failure			V4
Works calibration certificate for one (freely selectable) temperature and humidity value			D00105
Compressed air dehumidification (efficient dehumidification of the interior by means of compressed air - only ICHeco/ICH and ICHeco L/ICH L) Standard works calibration certificate (measuring point chamber centre) at +10 °C with 10 % rh			C9
Door with lock and key (safety lock)			B6
Potential-free contact for combination error message (e.g. supply failure, sensor fault, fuse)			H6
Door-open-recognition, shuts down humidity, light and CO <sub>2</sub> (standard with ICH C and ICHeco L/ICH L)			V5
MobileALERT, notification by SMS in case of any error or alarm of the device (requires option H6)			C3

Accessories	110	260	750
Stainless steel grid, electropolished	E20165	E28891	E20182
Reinforced stainless steel grid, electropolished, max. loading 60 kg; size 750 with guide bars and fixing screws (requires option K1). Please consider max. loading of chamber	E29767	E29766	B32190
Perforated stainless steel shelf	B00325	B29725	B00328
Reinforced stainless steel shelf, max. loading 60 kg; with guide bars and fixing screws (requires option K1). Please consider max. loading of chamber		-	B32191
Stainless steel slide-in drip tray, 15 mm rim (may affect the temperature distribution, not in connection with option K1)	E02073	E29726	E02075
Stainless steel slide-in drip tray, 15 mm rim, with guide bars and fixing screws (may affect the temperature distribution, only in connection with option K1)		-	B32763
Stainless steel bottom drip tray, 15 mm rim (may affect the temperature distribution, not in connection with option K1)	B04359	B29722	B04362
Stainless steel bottom drip tray, 15 mm rim (may affect the temperature distribution, only in connection with option K1)		-	B34055
Holder for water tank (2.5 litres) for mounting on the rear of the appliance. Standard equipment for size 750	E32172		-
Central water supply with filter cartridges for connection to the domestic water supply. Product information on demand		ZWVR6	
Central water supply without filter cartridges for connection to the domestic water supply (only for demineralised water with a conductivity of 5 to 10 µS/cm and a pH value between 5 and 7). Product information on demand		ZWVR7	
USB-Ethernet adapter		E06192	
Ethernet connection cable 5 m for computer interface		E06189	
USB User-ID stick (with User-ID licence): Oven-linked authorisation licence (User-ID-programme) on Memory-stick, prevents undesired manipulation by unauthorised third parties. When reordering please specify serial number		B33170	
FDA conforming software AtmoCONTROL (FDA edition). Meets the requirements for the use of electronically stored data sets and electronic signatures as laid down in Regulation 21 CFR Part 11 of the US Food and Drug Administration (FDA). Base licence for the control of one unit. Respective IQ/OQ documents available in German and English language (without surcharge)		FDAQ1	
Integration of additional units (up to max. 31 units) into an already existent FDA-software licence		FDAQ2	
External measuring instrument with sensors for daylight and UV-light. Product information on demand (only ICHeco L/ICH L)		B04713	
External measuring instrument with additional measuring head for temperature and humidity measurement. Product information on demand		B04714	
DAkKs calibration for one (freely selectable) temperature and humidity value according to method C (DKD-R 5-7)		E48847	
DAkKs calibration for further temperature and humidity values according to method C (DKD-R 5-7)		E48848	

Accessories	110	260	750
IQ document with device-specific works test data, OQ/PQ check list as support for validation by customer			D00124
IQ/OQ document with device-specific works test data for one free-selectable temperature value, incl. temperature distribution survey at Memmert for 27 measuring points to DIN 12880:2007-05. PQ check list as support for validation by customer. 305 € for further temperature values			D00127
IQ/OQ document with device-specific works test data for one free-selectable temperature and humidity value, incl. temperature distribution survey at Memmert for 27 measuring points to DIN 12880:2007-05, PQ check list as support for validation by customer. 475 € for further temperature and humidity values			D00136
IQ/OQ document with device-specific works test data for one free-selectable temperature and humidity value, and measuring of light intensity, incl. temperature distribution survey at Memmert for 27 measuring points to DIN 12880:2007-05, PQ check list as support for validation by customer (models ICHeco L/ICH L). 605 € for further temperature and humidity values, and measuring of light intensity			D00137
On-site IQ/OQ for a freely selectable temperature and humidity value, including temperature distribution survey for 27 measuring points to DIN 12880: 2007-05 (excluding travel costs, not subject to discount, GER, AT, FR only)			DLQ101
Extension of DLQ101 by an additional freely selectable temperature and humidity value (not subject to discount)			DLQ101A
Individual on-site Performance Qualification (PQ)			DLQ200
Maintenance ICH/ ICHeco - carrying out and documentation according to Memmert maintenance plan (excluding travel costs, not subject to discount, GER, AT, FR only)			S00322
Maintenance contract ICH/ ICHeco - carrying out and documentation according to Memmert maintenance plan, minimum duration 3 years (excluding travel costs, not subject to discount, GER, AT, FR only)			S00322J
Calibration of one freely selectable temperature value (excluding travel costs, not subject to discount, GER, AT, FR only)			S00205
Calibration of an additional temperature value (not subject to discount)			S00215
Calibration of one freely selectable temperature and humidity value (excluding travel costs, not subject to discount, GER, AT, FR only)			S00207
Calibration of an additional temperature and humidity value (not subject to discount)			S00216

## CLIMATE CHAMBERS ICH

according to DIN 12880:2007-05, EN 61010-1 (IEC 61010-1), EN 61010-2-010

Standard units are safety-approved and bear the test marks:



- Interior: Stainless steel, mat. 1.4301 (ASTM 304), deep-drawn
- Housing: Textured stainless steel, rear zinc-plated steel, intuitively operated TwinDISPLAY (TFT colour display) with touchscreen
- Double doors: Outside stainless steel, fully insulated, inside glass (size 750: two leaves)
- Connection: Mains cable with plug (German type)
- Installation: Mounted on lockable castors
- Interfaces:

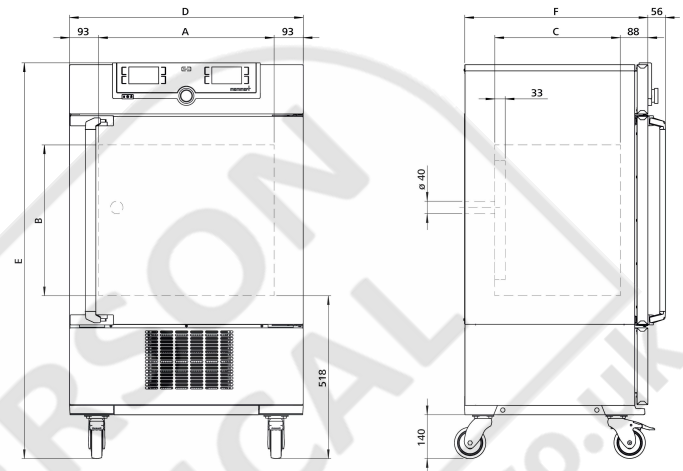

Model sizes/Description			110	260	750
Stainless steel interior	Volume	approx. l	108	256	749
	Width	(A) mm	560	640	1040
	Height	(B) mm	480	800	1200
	Depth (less 33 mm for fan)	(C) mm	400	500	600
	Max. number of grids/shelves	number	5	9	14
	Max. loading per grid/shelf	kg	20		30
	Max. loading of chamber	kg	150	200	
	Max. loading per slide-in drip tray	kg	3	4	8
Textured stainless steel exterior	Max. loading per bottom drip tray	kg	3	4	8
	Width	(D) mm	745	824	1224
	Height (with castors)	(E) mm	1233	1552	1950
	Depth (without door handle, depth of handle +56 mm)	(F) mm	585	685	785
Standard equipment	Stainless steel grids, electropolished	number	2		
	Entry port (silicone), 40 mm clear diameter, moisture tight, can be closed by a silicone stopper, standard position at the back		●		
	Water tank including connection hose		●		
	Standard works calibration certificate (measuring point chamber center)		+10, +37 and +30 °C with 60 % rh		
Temperature	Working temperature range without humidity ICH (not suitable for long-term storing at sub-zero temperatures. During permanent operation, the glass door may ice over)	°C	-10 to +60		
	Working temperature range ICH/ICH L with humidity and/or light	°C	+10 to +60		
	Working temperature range ICH C with and without humidity	°C	+10 to +50		
	Working temperature range ICH L without humidity	°C	0 to +60		
	Setting temperature range ICH	°C	-10 to +60		
	Setting temperature range ICH L	°C	0 to +60		
	Setting temperature range ICH C	°C	+10 to +50		
Humidity	Setting accuracy	°C	0.1		
	Setting range humidity	% rh	10 to 80		
CO <sub>2</sub> / O <sub>2</sub>	Setting accuracy	% rh	0.5		
	Digital electronic CO <sub>2</sub> control with autozero, NDIR system, with auto-diagnostic system and acoustic fault indication, barometric pressure compensation (only ICH C), setting range	% CO <sub>2</sub>	0 to 20	0 to 10	
	Setting accuracy CO <sub>2</sub> (only ICH C)	% CO <sub>2</sub>	0.1		
	Control accuracy CO <sub>2</sub> at 0 – 10 % CO <sub>2</sub>	%	+/- 0.2	+/- 0.3	
Light	Control accuracy CO <sub>2</sub> at 11 – 15 % CO <sub>2</sub>	%	+/- 0.5		
	Illumination unit (only ICH L) acc. ICH Q1B, option 2; separately switchable via controller, one box; Number of fluorescent lights with cold white light (size 110: 3, size 260/750: 4), light colour 865 6,500 K; Number of fluorescent lights with UV lamps (all sizes: 2), spectral range from 320 to 400 nm; (daylight and UV light comply with standard illuminant D65)		●		
Further data	Electrical load at 230/115 V, 50/60 Hz ICH L	approx. W	1450	1550	
	Electrical load at 230/115 V, 50/60 Hz ICH and ICH C	approx. W	1350		
Packing data	Net weight	approx. kg	109	160	249
	Gross weight (packed in carton)	approx. kg	137	217	319
	Width	approx. mm	880	930	1330
	Height	approx. mm	1410	1760	2150

Model sizes/Description		110	260	750
Packing data	Depth	approx. mm		810 930 1050
<b>Order No. Climate Chambers</b>		ICH110	ICH260	ICH750
ICH = Climate chamber		ICH110L	ICH260L	ICH750L
ICH L = Climate chamber with light		ICH110C	ICH260C	ICH750C
ICH C = Climate chamber with CO <sub>2</sub> control				
Options		110	260	750
Voltage 115 V, 50/60 Hz			X2	
Chamber modification for the application of reinforced perforated stainless steel shelves or stainless steel grids (bearing rails mounted in the working chamber) - includes replacement of standard grids by reinforced grids (ICHeco/ICH and ICH C only)				K1
illumination unit (has to be ordered together with the chamber) consisting of 4 fluorescent lights with cold white light (daylight: light colour 865, 6,500 K) and 2 UV lamps in the spectral range of 320 to 400 nm, acc. ICH Q1B, option 2 (daylight and UV light comply with standard illuminant D65) separately switchable via controller (only ICHeco L/ICH L)	second box	-	T72	
Alternative light boxes (replace the standard lighting; have to be ordered together with the chamber); number of fluorescent lamps: size 110: 5, sizes 260/750: 6, with cold white light (daylight: light colour 865, 6,500 K; daylight complies with standard illuminant D65) (only ICHeco L/ICH L)	one box		T81	
	second box (cannot be switched on separately)	-	T82	
Alternative light boxes (replace the standard lighting; have to be ordered together with the chamber); number of fluorescent UV lamps: size 110: 5, sizes 260/750: 6, in the spectral range of 320 to 400 nm; UV light complies with standard illuminant D65 (only ICHeco L/ICH L)	one box		T01	
	second box (cannot be switched on separately)	-	T02	
Interior socket, ampacity 230 V/2.2 A, can be switched off with the On/Off switch, cannot be switched individually, moisture tight IP68 (not for ICH110eco L/ICH110L)			R3	
Entry port, 23 mm clear diameter, for introducing connections at the side, moisture tight, can be closed by flap and silicone stopper, standard positions (F1 and F3 not for models ICHeco L/ICH L)	left centre/centre		F0	
	left centre/top right centre/top	-	F3	
Entry port (silicone), 40 mm clear diameter, moisture tight, can be closed by silicone stopper, at the back (please state location). Not for models ICHeco L/ICH L		-	F7	
4 - 20 mA current loop interface	Temperature controller actual value (-20 to +70 °C = 4 - 20 mA)		V3	
	Temperature of a Pt100 sensor positioned flexibly in chamber for external temperature monitoring (max. 3) - price per sensor (-20 to +70 °C = 4 - 20 mA)		V6	
	Humidity controller, actual value (0 to 100 % rh = 4 - 20 mA)		V7	
	CO <sub>2</sub> controller, actual value (0 to 25 % CO <sub>2</sub> = 4 - 20 mA) (only ICH C)		V9	
Fan speed monitoring with switching off the heating and with alarm in case of failure			V4	
Works calibration certificate for one (freely selectable) temperature and humidity value			D00105	
Works calibration certificate for one (freely selectable) temperature, humidity and CO <sub>2</sub> value according to customer specification (ICH C)			D00131	
Compressed air dehumidification (efficient dehumidification of the interior by means of compressed air - only ICHeco/ICH and ICHeco L/ICH L) Standard works calibration certificate (measuring point chamber centre) at +10 °C with 10 % rh			C9	
Door with lock and key (safety lock)			B6	
Potential-free contact for combination error message (e.g. supply failure, sensor fault, fuse)			H6	
Door-open-recognition, shuts down humidity, light and CO <sub>2</sub> (standard with ICH C and ICHeco L/ICH L)			V5	
MobileALERT, notification by SMS in case of any error or alarm of the device (requires option H6)			C3	
Accessories		110	260	750
Stainless steel grid, electropolished		E20165	E28891	E20182
Reinforced stainless steel grid, electropolished, max. loading 60 kg; size 750 with guide bars and fixing screws (requires option K1). Please consider max. loading of chamber		E29767	E29766	B32190
Perforated stainless steel shelf		B00325	B29725	B00328
Reinforced stainless steel shelf, max. loading 60 kg; with guide bars and fixing screws (requires option K1). Please consider max. loading of chamber				B32191
Stainless steel slide-in drip tray, 15 mm rim (may affect the temperature distribution, not in connection with option K1)		E02073	E29726	E02075
Stainless steel slide-in drip tray, 15 mm rim, with guide bars and fixing screws (may affect the temperature distribution, only in connection with option K1)				B32763
Stainless steel bottom drip tray, 15 mm rim (may affect the temperature distribution, not in connection with option K1)		B04359	B29722	B04362
Stainless steel bottom drip tray, 15 mm rim (may affect the temperature distribution, only in connection with option K1)				B34055
Holder for water tank (2.5 litres) for mounting on the rear of the appliance. Standard equipment for size 750			E32172	-
Central water supply with filter cartridges for connection to the domestic water supply. Product information on demand			ZWVR6	



Accessories	110	260	750
Central water supply without filter cartridges for connection to the domestic water supply (only for demineralised water with a conductivity of 5 to 10 µS/cm and a pH value between 5 and 7). Product information on demand			ZWVR7
CO <sub>2</sub> pressure reducing valve to DIN 8546, incl. gas cylinder monitor (only ICH C)			E02087
USB-Ethernet adapter			E06192
Ethernet connection cable 5 m for computer interface			E06189
USB User-ID stick (with User-ID licence): Oven-linked authorisation licence (User-ID-programme) on Memory-stick, prevents undesired manipulation by unauthorised third parties. When reordering please specify serial number			B33170
FDA conforming software AtmoCONTROL (FDA edition). Meets the requirements for the use of electronically stored data sets and electronic signatures as laid down in Regulation 21 CFR Part 11 of the US Food and Drug Administration (FDA). Base licence for the control of one unit. Respective IQ/OQ documents available in German and English language (without surcharge)			FDAQ1
Integration of additional units (up to max. 31 units) into an already existent FDA-software licence			FDAQ2
External measuring instrument with sensors for daylight and UV-light. Product information on demand (only ICHeco L/ICH L)			B04713
External measuring instrument with additional measuring head for temperature and humidity measurement. Product information on demand			B04714
DAkkS calibration for one (freely selectable) temperature and humidity value according to method C (DKD-R 5-7)			E48847
DAkkS calibration for further temperature and humidity values according to method C (DKD-R 5-7)			E48848
IQ document with device-specific works test data, OQ/PQ check list as support for validation by customer			D00124
IQ/OQ document with device-specific works test data for one free-selectable temperature value, incl. temperature distribution survey at Memmert for 27 measuring points to DIN 12880:2007-05. PQ check list as support for validation by customer. 305 € for further temperature values			D00127
IQ/OQ document with device-specific works test data for one free-selectable temperature and humidity value, incl. temperature distribution survey at Memmert for 27 measuring points to DIN 12880:2007-05, PQ check list as support for validation by customer. 475 € for further temperature and humidity values			D00136
IQ/OQ document with device-specific works test data for one free-selectable temperature and humidity value, and measuring of light intensity, incl. temperature distribution survey at Memmert for 27 measuring points to DIN 12880:2007-05, PQ check list as support for validation by customer (models ICHeco L/ICH L). 605 € for further temperature and humidity values, and measuring of light intensity			D00137
IQ/OQ document with device-specific works test data for one free-selectable CO <sub>2</sub> , humidity and temperature value, incl. temperature distribution survey at Memmert for 27 measuring points to DIN 12880:2007-05, PQ check list as support for validation by customer (models ICH C). 605 € for further CO <sub>2</sub> , humidity and temperature values			D38897
On-site IQ/OQ for a freely selectable temperature and humidity value, including temperature distribution survey for 27 measuring points to DIN 12880: 2007-05 (excluding travel costs, not subject to discount, GER, AT, FR only)			DLQ101
Extension of DLQ101 by an additional freely selectable temperature and humidity value (not subject to discount)			DLQ101A
On-site IQ/OQ for a freely selectable temperature and CO <sub>2</sub> value, including temperature distribution survey for 27 measuring points to DIN 12880: 2007-05 (models ICH C) (excluding travel costs, not subject to discount, GER, AT, FR only)			DLQ102
Extension of DLQ102 by an additional freely selectable temperature and CO <sub>2</sub> value (models ICH C) (not subject to discount)			DLQ102A
On-site IQ/OQ for a freely selectable temperature, humidity and CO <sub>2</sub> value, including temperature distribution survey for 27 measuring points to DIN 12880: 2007-05 (models ICH C) (excluding travel costs, not subject to discount, GER, AT, FR only)			DLQ103
Extension of DLQ103 by an additional freely selectable temperature, humidity and CO <sub>2</sub> value (models ICH C) (not subject to discount)			DLQ103A
Individual on-site Performance Qualification (PQ)			DLQ200
Maintenance ICH-C - carrying out and documentation according to Memmert maintenance plan (excluding travel costs, not subject to discount, GER, AT, FR only)			S00316
Maintenance contract ICH-C - carrying out and documentation according to Memmert maintenance plan, minimum duration 3 years (excluding travel costs, not subject to discount, GER, AT, FR only)			S00316J
Maintenance ICH/ ICHeco - carrying out and documentation according to Memmert maintenance plan (excluding travel costs, not subject to discount, GER, AT, FR only)			S00322
Maintenance contract ICH/ ICHeco - carrying out and documentation according to Memmert maintenance plan, minimum duration 3 years (excluding travel costs, not subject to discount, GER, AT, FR only)			S00322J
Calibration of one freely selectable temperature value (excluding travel costs, not subject to discount, GER, AT, FR only)			S00205
Calibration of an additional temperature value (not subject to discount)			S00215
Calibration of one freely selectable temperature and humidity value (excluding travel costs, not subject to discount, GER, AT, FR only)			S00207
Calibration of an additional temperature and humidity value (not subject to discount)			S00216
Calibration of one freely selectable temperature and humidity value including CO <sub>2</sub> (excluding travel costs, not subject to discount, GER, AT, FR only)			S00211
Calibration of an additional temperature and humidity value including CO <sub>2</sub> (not subject to discount)			S00217



Climatic test chamber CTC  
with humidity control  
Temperature test chamber TTC  
"Celsius" standard software

Model size: 256  
- 42 °C to +190 °C (without humidity)  
+10 °C to +95 °C (CTC with humidity)  
Humidity 10 to 98 % rh (CTC)

## CLIMATIC TEST CHAMBER CTC / TEMPERATURE TEST CHAMBER TTC

In Memmert environmental test chambers CTC and TTC, the perfect atmosphere for climate and temperature tests, specifically in accordance with IEC 60068 are simulated. Ramp operation, active humidification and dehumidification of 10 to 98 % rh and precise temperature control from -42 °C to +190 °C (without humidity) with humidity control from +10 °C to +95 °C provide unlimited flexibility for controlled material and function tests as well as ageing tests.





## Reliable and efficient climate technology

The components of the climate system interact perfectly for quick, precise and energy-saving temperature changes. The 3-layer insulation system for the chamber, derived from aerospace engineering applications, impresses with an excellent K-value and prevents moisture penetration of the insulation material. The electronically controlled injection of refrigerants guarantees an optimal cooling performance and thanks to the automatic defrosting system, the TTC and CTC test chambers run in continuous operation without interruption.

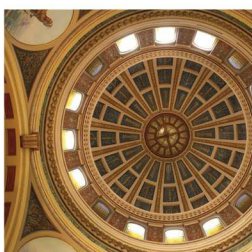

The stainless steel evaporator stands out with a long and corrosion-free life and the twin-compressor, regulated according to the output, saves valuable energy. The temperature-dependent speed-controlled condenser fan ensures low noise level in partial load operation.

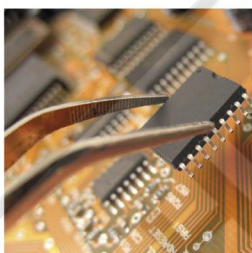

## Economical at high performance

The high level of standardisation and the highly efficient principle of equal parts in production at Memmert allow an extensive range of standard features, along with constantly excellent quality at an outstanding cost/benefit ratio. However, this high-performance duo proves to be extremely cost-efficient not only in their procurement costs, but also in their operating costs. Thanks to the steam generator and the twin compressor, which is regulated according to the output, the CTC consumes only about half of what standard environmental simulation chambers do in climate control operation.

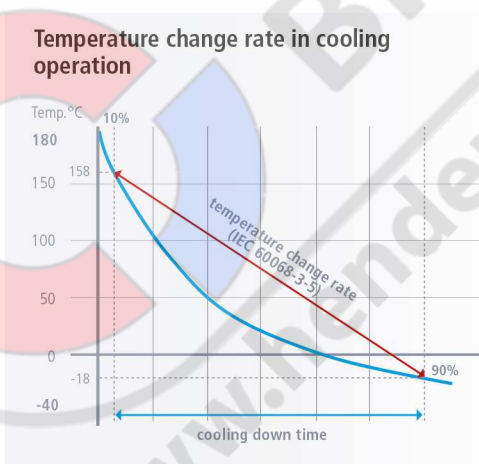

According to Newton's law of cooling, the rate of temperature change follows an exponential curve. The rate of temperature change calculated according to IEC 60068-3-5 applies to cooling from 90 % to 10 %. In the upper temperature range, the rate of temperature change is significantly higher, in the lower temperature range it is significantly lower.

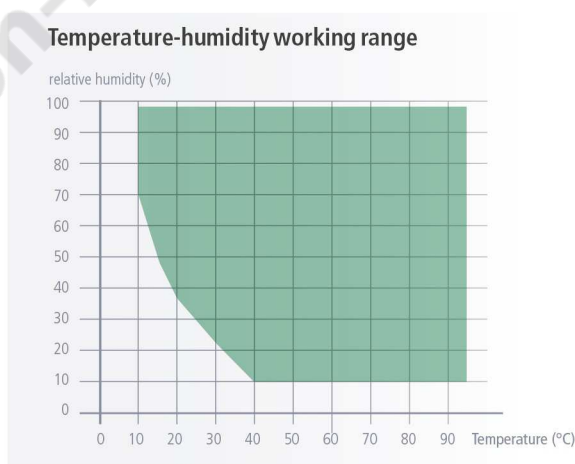

Note:

Within the respective temperature-humidity range, condensation-free permanent operation is possible. To which extent condensation may occur in the threshold range depends on the humidity content of the chamber load and the ambient conditions.

**ENVIRONMENTAL TEST CHAMBERS CTC / TTC**

according to DIN 12880:2007-05, EN 61010-1 (IEC 61010-1), EN 61010-2-010, IEC 60068

Standard units are safety-approved and bear the test marks: **CE EAC**

- Interior: Stainless steel, material 1.4301 (ASTM 304)
- Housing: Textured stainless steel, rear zinc-plated steel, aesthetic functional glass-stainless steel operating panel with multifunction display and input module
- Door: Stainless steel, fully insulated, heated
- Connection: Mains cable with plug (CEE)
- Installation: Mounted on lockable castors



Ethernet interface is optional (extra cost)

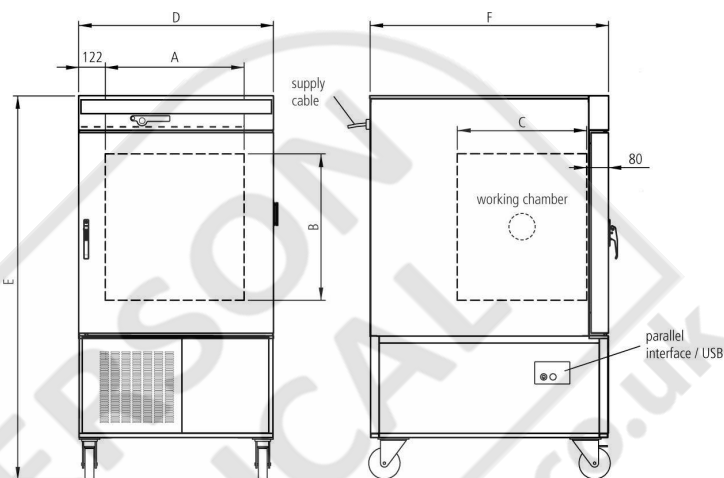

Model sizes/Description		CTC256	TTC256
Stainless steel interior	Volume	approx. l	256
	Width	(A) mm	640
	Height	(B) mm	670
	Depth	(C) mm	597
	Support ribs for stainless steel grids	number	6
	Max. loading per grid	kg	25
Textured stainless steel exterior	Max. loading of chamber	kg	100
	Width (plus 20 mm for silicone plug and 5 mm for interfaces)	(D) mm	898
	Height	(E) mm	1730
	Depth (without door handle, depth of handle +50 mm)	(F) mm	1100
	Fully insulated heated stainless steel door		●
	Lockable castors for ease of transport		●
Standard equipment	Stainless steel grids, electropolished	number	1
	Entry port right, 80 mm, with stopper		●
	High-performance air fan, speed adjustable in 10 % steps with monitoring function of fan speed and automatic speed adjustment		●
	Works calibration certificate (measuring point chamber centre)	°C	-20 and +160
	Works calibration certificate (measuring point chamber centre)		+30 °C and 60 % rh
Temperature	Electronic microprocessor temperature controller with Pt100 and auto-diagnostic system		●
	Temperature sensors Pt100 Class A in 4-wire circuit for uninterrupted operation on failure of one Pt100 with warning indication		double
	Temperature range with humidity control	°C	+10 to +95
	Temperature range without humidity control	°C	-42 to +190
	Setting accuracy	°C	-42 to 99,9: 0.1 / 100 to 190: 0.5
	Temperature change rate in heating operation (acc. to IEC 60068-3-5) -40 °C to +180 °C measured at an ambient temperature of 22 °C	°C	10 K / minute
	Temperature change rate in cooling operation (acc. to IEC 60068-3-5) +180 °C to -40 °C measured at an ambient temperature of 22 °C	°C	3 K / minute
	Temperature variation in time (setpoint dependent of min. temperature up to +150 °C and humidity > 20 %)	K	± 0.2 ... 0.5
	Temperature uniformity in chamber (setpoint dependent)	K	± 0.5 ... 2
Humidity	Capacitive humidity sensor		●
	Active microprocessor control for humidifying and dehumidifying (10 - 98 % rh) incl. digital indication and auto-diagnostic system ensures rapid reaching of set humidity and very short recovery times; humidity supply with water (only for demineralised water with a conductivity of 5 to 10 µS/cm and a pH value between 5 and 7; from an external tank) by self-priming pump		●
	Humidity stability in time	% rh	± 1 ... 3
	Telescopic slide for each 2 x 10 l tanks for water (only for demineralised water with a conductivity of 5 to 10 µS/cm and a pH value between 5 and 7) as well as 2 x 10 l tanks as condensate collector		●
	Automatic water tank change-over with alarm for continuous operation		●



Model sizes/Description		CTC256	TTC256
Control technology	Timer with residual running time: max. 40 ramps (each 1 min. up to 999 h) programmable through controller or MEMoryCard XL; programming via PC and free-of-charge software: unlimited number of ramps		●
	Real-time/weekly programmer with group function (e.g. Monday – Friday)		●
	Calibration (no separate PC required), Temperature: 3-point calibration on controller		●
	Calibration (no separate PC required), humidity: 2-point calibration at 20 % and 90 % rh	●	-
	Setting of language for dialogue and display DE / EN / ES / FR / IT		●
	Microprocessor temperature monitor acting as overtemperature protection (protection class 3.3), with Pt100 incorporating fault diagnostics with visual and acoustic alarm		●
	Temperature monitoring band automatically linked to the setpoint (ASF)		●
	Monitor relay for reliable heating cut-off in case of fault		●
Communication	Mechanical temperature limiter (TB)		●
	Internal log memory 1024 kB as ring memory for all setpoints, actual values, errors, settings with real-time and date; capacity approx. 3 months (CTC) resp. 6 months (TTC) at 1 min. intervals		●
	Parallel printer interface for printing logging files, suitable for all PCL3- compatible ink jet printers (USB available via converter, see accessories)		●
Refrigeration	"Celsius" software for control and documentation of temperature and relative humidity (CTC)		●
	High-performance twin compressor (refrigerant R449A) with adjustable speed condenser fan and electronically controlled refrigerant injection		●
Light	Large-area stainless steel evaporator		●
	Halogen interior lighting 2 x 25 W		●
Further data	Acoustic and optical alarm: Door-open		●
	Acoustic and optical alarm: Empty water tank	●	-
	Acoustic and optical alarm: Over- and undertemperature		●
	Acoustic and optical alarm: Underhumidity	●	-
	Electrical load at 400 V, 3 ph N, 50 Hz	approx. W	7000
Packing data	Net weight	approx. kg	337
	Gross weight (packed in carton)	approx. kg	463
	Width	approx. mm	1020
	Height	approx. mm	1910
	Depth	approx. mm	1310
<b>Order No. Climatic Test Chamber – Temperature Test Chamber</b>		<b>CTC256</b>	<b>TTC256</b>
Options		CTC256	TTC256
Works calibration certificate for one (freely selectable) temperature value according to customer specification		-	D00109
Works calibration certificate for one (freely selectable) temperature and humidity value according to customer specification		D00105	-
Door hinged on the left			B8
Full-sight glass door (5-layer insulating glazing), heated			B0
Entry port, left, 80 mm, with stopper			F0
Interface Ethernet instead of USB including software			W4
RS232 interface instead of USB			W6
Potential-free contact (24 V/2 A) with socket, for combination error message (e.g. supply failure, sensor fault, fuse)			H6
MobileALERT, notification by SMS in case of any error or alarm of the device (requires option H6)			C3
Accessories		CTC256	TTC256
Stainless steel grid, electropolished			E20591
External control and logging package consisting of mini-Notebook and software "Celsius", pre-configured, and lateral swivel arm			B04410
USB connection cable for computer interface			E03643
Temperature profile write/read unit for programming via PC, for writing to and reading from the chip card, up to 40 ramps			E05284
Additional chip card, blank, formatted (32 kB MEMoryCard XL for a maximum of 40 ramps)			E04004
Oven-linked authorisation card (User-ID-Card) prevents undesired manipulation by unauthorised third parties. When reordering please specify serial number			E04159
Software conforming to FDA "Celsius FDA Edition". Meets the requirements for the use of electronically stored data sets and electronic signatures as laid down in Regulation 21 CFR Part 11 of the US Food and Drug Administration (FDA). Base licence for the control of one unit			E05019
Integration of additional units (up to max. 15 units) into an already existent FDA-software licence (E05019)			FDAQ4
External measuring instrument with sensors for daylight and UV-light, with additional measuring head for temperature and humidity. Product information on demand		B04714	-
DAkKS calibration for one (freely selectable) temperature and humidity value according to method C (DKD-R 5-7)		E48847	-
DAkKS calibration for further temperature and humidity values according to method C (DKD-R 5-7)		E48848	-
DAkKS calibration for one free-selectable temperature value according to method C (DKD-R 5-7)			E39696
DAkKS calibration for further temperature values according to method C (DKD-R 5-7)			E39697
IQ check list with device-specific works test data as support for validation by customer			D00103
OQ check list with device-specific works test data for one free-selectable temperature value, incl. temperature distribution survey at Memmert for 27 measuring points to DIN 12880:2007-05 as support for validation by customer			D00104
OQ check list with device-specific works test data for one free-selectable humidity and temperature value, incl. temperature distribution survey at Memmert for 27 measuring points to DIN 12880:2007-05 as support for validation by customer		D00144	-

Accessories	CTC256	TTC256
On-site IQ/OQ for a freely selectable temperature and humidity value, including temperature distribution survey for 27 measuring points to DIN 12880: 2007-05 (excluding travel costs, not subject to discount, GER, AT, FR only)	DLQ101	-
Extension of DLQ101 by an additional freely selectable temperature and humidity value (not subject to discount)	DLQ101A	-
On-site IQ/OQ for a freely selectable temperature value, including temperature distribution survey for 27 measuring points to DIN 12880: 2007-05 (excluding travel costs, not subject to discount, GER, AT, FR only)	-	DLQ100
Extension of DLQ100 by an additional freely selectable temperature value (not subject to discount)	-	DLQ100A
Individual on-site Performance Qualification (PQ)		DLQ200
Maintenance "Basic" - carrying out and documentation according to Memmert maintenance plan (excluding travel costs, not subject to discount, GER, AT, FR only)		S00400
Maintenance "Medium" - carrying out and documentation according to Memmert maintenance plan (excluding travel costs, not subject to discount, GER, AT, FR only)		S00401
Maintenance "Premium" - carrying out and documentation according to Memmert maintenance plan (excluding travel costs, not subject to discount, GER, AT, FR only)		S00402
Calibration of one freely selectable temperature value (excluding travel costs, not subject to discount, GER, AT, FR only)		S00205
Calibration of an additional temperature value (not subject to discount)		S00215
Calibration of one freely selectable temperature and humidity value (excluding travel costs, not subject to discount, GER, AT, FR only)	S00207	-
Calibration of an additional temperature and humidity value (not subject to discount)	S00216	-

The image shows a large sheet of white lined paper with horizontal ruling lines. A large, semi-transparent watermark is overlaid diagonally across the page. The watermark features a stylized 'C' logo on the left, composed of a red upper half and a blue lower half. To the right of the logo, the text 'HENDERSON BIOMEDICAL' is written in a large, bold, sans-serif font. Below this, the website address 'www.henderson-biomedical.co.uk' is written in a smaller font. In the bottom right corner of the page, a woman with dark hair, wearing a red shirt, is partially visible, smiling and pointing her right index finger towards the lined paper.

## DECISION AID FOR PRODUCTS WITH HUMIDITY CONTROL

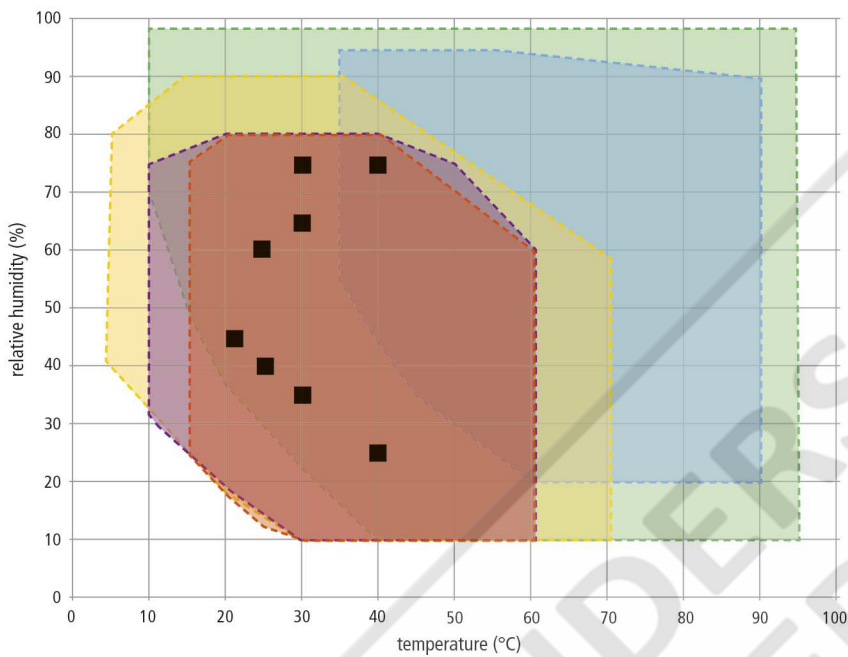

### Explanation of diagram:

Within the respective temperature-humidity range, condensation-free permanent operation is possible. To which extent condensation may occur in the threshold range depends on the humidity content of the chamber load and the ambient conditions.

- ICHeco/ICH
- HPP110eco-HPP1060eco
- HPP1400eco/2200eco
- HCP
- CTC
- Climate testing points according to ICH guidelines

### Model selection

Model size in litres (= dm <sup>3</sup> )	ICHeco/ICH	HPPeco		HCP	CTC
56				HCP50	
107				HCP105	
108	ICH110eco/ICH110	HPP110eco			
156				HCP150	
241				HCP240	
256	ICH260eco/ICH260	HPP260eco			CTC256
384		HPP410eco			
749	ICH750eco/ICH750	HPP750eco			
1060		HPP1060eco			
1360			HPP1400eco		
2140			HPP2200eco		
Temp. with hum.	+10 to +60 °C	5 <sup>2</sup> to +70 °C	15 <sup>3</sup> to +60 °C	7 <sup>1</sup> to +90 °C	+10 to +95 °C
Temp. w/o hum.	-10 to +60 °C	0 <sup>2</sup> to +70 °C	15 <sup>3</sup> to +60 °C	7 <sup>1</sup> to +90 °C	-42 to +190 °C
Humidity range	10 to 80 % rh	10 to 90 % rh	10 to 80 % rh	20 to 95 % rh	10 to 98 % rh
Ambient conditions	+19 to +25 °C, max 50 % rh according to Memmert works standard				

<sup>1</sup> above ambient temperature

<sup>2</sup> at least 20 °C below ambient temperature

<sup>3</sup> at least 10 °C below ambient temperature

### Important notes concerning working ranges

If the temperature-humidity values exceed the specific limits (working range), the superheated steam introduced will immediately condense at the coldest point in the appliance, due to the dew point.

If the temperature-humidity values fall below the specific limits (working range), the effective range is heavily dependent on the humidity content of the chamber load.

The higher the humidity content of the chamber load, the more steam is generated inside the chamber. This may influence the maintenance of the constant humidity. If you need constant stable operation at the edges or the chamber load is very humid, we recommend dehumidifying with compressed air. We also have other technical solutions for special needs that guarantee stable operation. Send us your inquiry!

To support you in choosing the right appliance, the Memmert TechLab MPTC is always available for tests under realistic conditions. Your customer service representative will gladly establish contact.



## MODEL VARIANTS

SingleDISPLAY ControlCOCKPIT with one TFT display	TwinDISPLAY ControlCOCKPIT with two TFT displays
<b>AVAILABLE APPLIANCES</b> UN / UF / IN / IF / IPPeco / IPP / UNm / UFm / INm / IFm / SN / SF / IFbw	<b>AVAILABLE APPLIANCES</b> HPPeco / ICHeco / ICH / HCP / UNplus / UFplus / UF TS / UNpa / VO / INplus / IFplus / ICO / IPPecoplus / IPPplus / ICPeco / ICP / UNmplus / UFmplus / INmplus / IFmplus / SNplus / SFplus / ICOfmed
One high-resolution TFT colour display with touch-sensitive buttons for selection of functions	Two high-resolution TFT colour displays with touch-sensitive buttons for selection of functions
Available parameters on the ControlCOCKPIT: Temperature (Celsius or Fahrenheit), fan speed, exhaust air flap position, programme time	Available parameters on the Control COCKPIT: All parameters of the SingleDISPLAY and device-specific parameters like relative humidity, illumination and CO <sub>2</sub>
One temperature sensor Pt100 DIN class A in a 4-wire circuit	Two Pt100 sensors DIN class A in a 4-wire circuit for mutual monitoring, taking over functions in case of an error
	HeatBALANCE function for application specific adjustment of heat output distribution (balance) between the upper and lower heating groups in an adjustment range between -50 % and +50 % (not valid for models 30, HPP110eco, IPP110ecoplus, ICPeco, ICP, ICHeco, ICH)
AtmoCONTROL software <sup>1)</sup> for reading out, managing and organising the data logger via Ethernet interface (temporary trial version can be downloaded). USB stick with AtmoCONTROL software available as accessory (on demand)	AtmoCONTROL software <sup>1)</sup> on a USB stick for programming, managing and transferring programmes via Ethernet interface or USB port
	ControlCOCKPIT with USB port for uploading programmes, reading out protocol logs, activating the User-ID function
	Displaying of already logged protocol data on the ControlCOCKPIT (max 10,000 values correspond to approx. 1 week)
Ethernet interface on the rear of the appliance for reading out the protocol log and for online logging	Ethernet interface on the rear of the appliance for reading out the protocol log and for uploading programmes and for online logging
Double overtemperature protection: Electronic temperature monitoring with freely adjustable monitoring temperature, for models U, I, S with option A6 TWW/TWB (protection class 3.1 or 2), mechanical temperature limiter TB acc. to DIN 12880	Multiple overtemperature protection: Electronic temperature monitoring TWW/TWB (protection class 3.1 or 2 resp. 3.3 for units with active cooling) and mechanical temperature limiter TB (protection class 1) acc. to DIN 12880, AutoSAFETY automatically adjusts to the set value within a freely adjustable tolerance range. Setting individual MIN / MAX values for over/undertemperature and also for all other parameters such as relative humidity, CO <sub>2</sub>
PID microprocessor control with integrated auto-diagnostic system	
Structured stainless steel housing, scratch-resistant, robust and durable; rear of zinc-plated steel	
High-temperature connectors on the rear of the appliance for single-phase power connection according to country specific systems and IEC standards	
Internal data logger with a storage capacity of at least 10 years	
German, English, French, Spanish, Polish, Czech, Hungarian language settings available on the ControlCOCKPIT	
Digital backwards counter with target time setting, adjustable from 1 minute to 99 days	
The SetpointWAIT function guarantees that the process time does not start until the set temperature is reached at all measuring points – optional for temperature values recorded by the freely positionable Pt100 sensors inside the chamber	
Adjustment of three calibration values for temperature and additional appliance specific parameters directly at the ControlCOCKPIT	

<sup>1)</sup> As a manufacturer, Memmert GmbH + Co. KG clearly labels its devices, which are medical devices in the sense of the European legislation. The AtmoCONTROL software is not a medical device. All Memmert medical devices can be used for their purpose without the software AtmoCONTROL. AtmoCONTROL is only intended for reading the data logging in conjunction with Memmert GmbH + Co. KG medical devices.

## SOFTWARE AtmoCONTROL

### AtmoCONTROL

The innovative control and logging software

Parameters such as temperature and humidity as well as the process time can be set directly at the ControlCOCKPIT. Ramp programming is done via the control and logging software AtmoCONTROL.

### Drag, drop & go!

Numerical and graphic programming of complex processes is a thing of the past. Today, programming is done via AtmoCONTROL by means of the mouse or touchpad on your notebook. Even the most complex ramp programmes are created within minutes. Simply drag & drop the graphical symbols for the desired parameters to the input field and change the values according to your wishes with a mouse click.

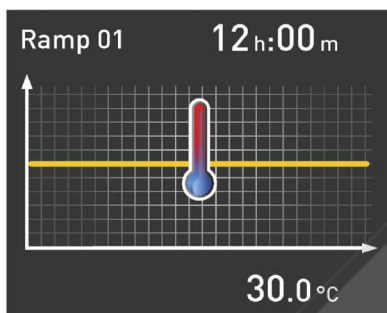

### Programme functions for appliances with SingleDISPLAY and TwinDISPLAY

- Reading out, managing and organising the data logger
- Saving the log memory in various formats
- Online monitoring of up to 32 connected appliances
- Optical alarms when the alarm limits individually set at the ControlCOCKPIT are exceeded
- Automatic alarm to one or several e-mail addresses

### Additional functions for appliances with TwinDISPLAY

- Intuitive programming and archiving of ramps and programme sequences
- Synchronous visualisation of the created programme sequence during programming
- Application-specific repeat functions (loops) can be inserted within a temperature control programme in any place
- Simple creation of repeating weekly programmes
- Programming, managing and transferring programmes via Ethernet interface or USB port

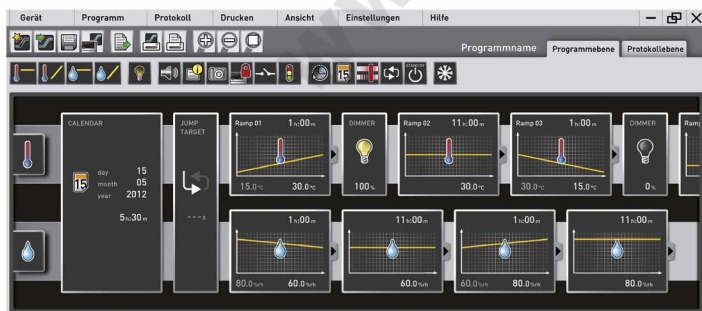

## 24 HOURS AT YOUR SERVICE

[www.memmert.com](http://www.memmert.com)

Here you can find the latest news concerning our company and products, as well as detailed descriptions of every single product. Additional information on the technologies used will support your sales arguments. In addition to this, data sheets, certificates, operating instructions and brochures are available for download. Service notifications can be submitted to our service team using the corresponding form.

### Dedicated login area for our trading partners

- Technical information:  
Service instructions, software download, wiring diagrams, maintenance schedules etc.
- Marketing/sales information:  
Press releases, product photos, image photos, videos, order form for advertising material etc.
- Download of price list and customisation department price list
- Dates and registration form for sales and service trainings

#### Our tip:

.....  
Please consider the Memmert customer information, which we regularly send exclusively to our trading partners. We inform you about campaigns, upcoming product launches, **service offers** and new application reports!

HENDERSON  
BIOMEDICAL  
www.henderson-biomedical.co.uk

## Device Modifications - Proven and Good

### The perfect extension for your Memmert appliance

Our mission at Memmert is to provide you with the best possible solution for your individual application. With the increasing complexity of customer processes, a custom-fit modification of our appliances has many advantages for your application. Through modifications, process and set-up times can be significantly reduced or errors in the application can be completely ruled out by monitoring devices. Even small measures, such as individually adapted accessories, have a noticeable influence on the ergonomics and user-friendliness in the operation of the appliance.

You as a customer have the best ideas - and often already have a specific idea of how our products can be better used in your working environment.

Tell us about your thoughts and let us create an individual solution together with you! Please contact us and call us at +49 9122-925-0 or send us an email to [sonderbau@memmert.com](mailto:sonderbau@memmert.com).

The Memmert customisation department team is looking forward to hearing from you!

## Versatile modifications for our standard appliances



### Mechanics

- Customised interior fittings
- Individual entry ports in all sizes and shapes
- Telescopic slide pull-outs for ergonomic loading



### Electronics

- Extended parameter monitoring e.g. by means of additional measuring sensors
- Optical and acoustic process monitoring e.g. by means of a traffic light system



### Software

- Additional interfaces for data evaluation
- Individual temperature, humidity and CO<sub>2</sub> parameters



### Accessories

- Tailor-made subframe and stacking options
- Modified grids and shelves
- Individual air filters



## Customised solutions for your requirements

### Our expertise as a development partner in plant and project business

The Memmert customisation department has been active in the project business for over 20 years now and has proven itself in countless projects as a strong and reliable partner. The experts in customisation benefit from two aspects: Access to the complete capacities of an ultra-modern and specialised production line, as well as the entire technical know-how of the Memmert company in designing climate and temperature control appliances. Combined with the experience of our project managers, the Memmert customisation department is also able to find a solution for the most complex requirements.

### Special sizes

Does your product not fit into a standard unit? We build appliances to measure! Whether you need more volume in the interior or there is not enough space for installation at the installation location, we have the expertise to design your appliance individually. Ask us!

### Process and plant integration

Integrate our technology seamlessly into your plant or your work organisation. We will find the right solution together for your process integration:

- Preparation for integration into your plant
- Integration of your processes into our appliances
- Inclusion of customer-specific installations
- Interface for semi-automatic assembly

### Project business

Are you a project developer with ideas for innovative products and looking for a strategic cooperation? Take advantage of our know-how and manufacturing capacities for your project. Our customisation department will be pleased to hear from you!



www.henderson-biomedical

# memmert

## CLIMATE CHAMBERS

CONSTANT CLIMATE CHAMBERS HPPeco

HUMIDITY CHAMBERS HCP

CLIMATE CHAMBERS ICHeco / ICH

ENVIRONMENTAL TEST CHAMBERS CTC / TTC

## HEATING AND DRYING OVENS

UNIVERSAL OVENS U

PASS-THROUGH OVENS UFTS

PARAFFIN OVENS UNpa

VACUUM OVENS VO

## INCUBATORS

INCUBATORS I

CO<sub>2</sub> INCUBATORS ICO

COMPRESSOR-COOLED INCUBATORS ICPeco / ICP

PELTIER-COOLED INCUBATORS IPPeco

## MEDICAL DEVICES

UNIVERSAL OVENS Um

INCUBATORS Im

STERILISERS S

CO<sub>2</sub> INCUBATORS ICOmed

BLANKET WARMERS IFbw

## WATERBATHS

WATERBATHS WTB

YOUR MEMMERT PARTNER

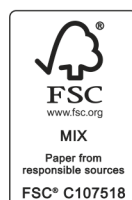

Memmert GmbH + Co. KG  
P.O. Box 1720 | D-91107 Schwabach  
Tel. +49 9122 925-0 | Fax +49 9122 14585  
E-Mail: sales@memmert.com  
facebook.com/memmert.family  
instagram.com/memmert.family



***LABORATORY EQUIPMENT MAINTENANCE, REPAIR, CALIBRATION AND SALES***

Established in 1987, Henderson Biomedical is the UK's leading laboratory equipment sales and service provider. Our knowledgeable team can provide you with excellent sales advice on a range of different types of laboratory equipment including centrifuges, refrigerators, freezers and heat sealers.

Henderson Biomedical is also able to provide you with first class after-sales service and calibration of your laboratory equipment. We are an **ISO 17025 (UKAS) accredited calibration test laboratory** and our team of Field Service Engineers cover the whole of the United Kingdom.

Please contact us for more information on the types of equipment we supply and the different after-sales services we can offer.

**Henderson Biomedical**

Unit 3, Swan Close  
Croydon CR0 2DZ  
United Kingdom

**Tel: 020 8663 4610**

**For sales enquiries: [sales@henderson-biomedical.co.uk](mailto:sales@henderson-biomedical.co.uk)**  
**For all other enquiries: [info@henderson-biomedical.co.uk](mailto:info@henderson-biomedical.co.uk)**  
**[www.henderson-biomedical.co.uk](http://www.henderson-biomedical.co.uk)**

