

ROTOFIX 32 A



Inhalt des Dokuments / content of the document

Gebrauchsanweisung (DE)

Operating instructions (EN)

Mode d'emploi (FR)

Istruzioni per l'uso (IT)

Rotoren und Zubehör / Rotors and accessories



Gebrauchsanweisung

ROTOFIX 32 A



Originalgebrauchsanweisung

©2023 - Alle Rechte vorbehalten
Andreas Hettich GmbH & Co. KG

Föhrenstraße 12

D-78532 Tuttlingen/Deutschland

Telefon: +49 (0)7461/705-0

Telefax: +49 (0)7461/705-1125

E-Mail: info@hettichlab.com, service@hettichlab.com

Internet: www.hettichlab.com



Inhaltsverzeichnis

1	Zu diesem Dokument.	5
1.1	Anwendung dieses Dokuments.	5
1.2	Gender-Hinweis.	5
1.3	Symbole und Kennzeichnungen in diesem Dokument.	5
2	Sicherheit.	5
2.1	Vorgesehene Zweckbestimmung.	5
2.2	Anforderungen an das Personal.	6
2.3	Verantwortung des Betreibers.	7
2.4	Sicherheitshinweise.	7
3	Geräteübersicht.	9
3.1	Technische Daten.	9
3.2	Europäische Registrierung.	11
3.3	Wichtige Schilder auf der Verpackung.	12
3.4	Wichtige Schilder am Gerät.	12
3.5	Bedien- und Anzeigeelemente.	13
3.5.1	Steuerung.	13
3.5.2	Anzeigeelemente.	13
3.5.3	Bedienelemente.	13
3.6	Originalersatzteile.	14
3.7	Lieferumfang.	14
3.8	Rücksendung.	15
4	Transport und Lagerung.	15
4.1	Transport- und Lagerbedingungen.	15
4.2	Transportsicherung befestigen.	16
5	Inbetriebnahme.	16
5.1	Auspacken der Zentrifuge.	16
5.2	Transportsicherung entfernen.	17
5.3	Aufstellen und Anschließen der Zentrifuge.	18
5.4	Zentrifuge ein- und ausschalten.	19
6	Bedienung	19
6.1	Deckel öffnen und schließen.	19
6.2	Rotor aus- und einbauen.	20
6.3	Gehänge einsetzen und herausnehmen.	22
6.4	Adapter einsetzen und herausnehmen.	22
6.5	Beladen.	23
6.6	BIO-Sicherheitssystem öffnen und schließen.	25
6.6.1	Erläuterung.	25
6.6.2	Deckel mit Schraubverschluss.	26
6.7	Zentrifugation.	26
6.7.1	Zentrifugation im Dauerlauf.	26
6.7.2	Zentrifugation mit Zeitvorwahl.	26
6.7.3	Kurzzeitzentrifugation.	27

7	Softwarebedienung	27
7.1	Zentrifugationsparameter	27
7.1.1	Bremsstufe einstellen	27
7.1.2	Relative Zentrifugalbeschleunigung RCF	28
7.1.3	Zentrifugation von Stoffen oder Stoffgemischen mit einer höheren Dichte als 1,2 kg/dm ³	28
7.1.4	Zentrifugerradius	29
7.2	Rotorerkennung	29
7.3	Machine Menu	29
7.3.1	Akustisches Signal	29
7.3.1.1	Allgemeines	29
7.3.1.2	Akustisches Signal einstellen	29
8	Reinigung und Pflege	30
8.1	Übersichtstabelle	30
8.2	Hinweise zur Reinigung und Desinfektion	30
8.3	Reinigung	31
8.4	Desinfektion	32
8.5	Wartung	33
9	Störungsbehebung	34
9.1	Fehlerbeschreibung	34
9.2	NETZ-RESET durchführen	35
9.3	Notentriegelung	35
9.4	Netzeingangssicherung tauschen	36
10	Entsorgung	37
10.1	Allgemeine Hinweise	37
11	Index	39

1 Zu diesem Dokument

1.1 Anwendung dieses Dokuments

- Vor dem ersten Inbetriebnehmen des Geräts dieses Dokument vollständig und sorgfältig lesen.
Gegebenenfalls weitere beiliegende Hinweisblätter beachten.
- Dieses Dokument ist teil des Geräts und ist gut erreichbar aufzubewahren.
- Dieses Dokument bei Weitergabe des Geräts an Dritte beifügen.
- Die aktuelle Version des Dokuments in den verfügbaren Sprachen ist auf der Internetseite des Herstellers zu finden: ➔ <https://www.hettichlab.com/de/download-center/>

1.2 Gender-Hinweis

Die verwendete maskuline oder feminine Sprachform dient der leichteren Lesbarkeit. Im Sinne der Gleichbehandlung gelten entsprechende Begriffe grundsätzlich für alle Geschlechter und beinhalten keine Wertung.

1.3 Symbole und Kennzeichnungen in diesem Dokument

Allgemeine Symbole

Zur Hervorhebung von Handlungsanweisungen, Ergebnissen, Auflistungen, Verweisen und anderen Elementen werden in diesem Dokument folgende Kennzeichnungen verwendet:

Kennzeichnung	Erläuterung
1. → 2. → 3. → ... →	Schritt-für-Schritt-Handlungsanweisungen
➔	Ergebnisse von Handlungsschritten
➡	Verweise auf Abschnitte des Dokuments und auf mitgelieferte Unterlagen
■ ... ■ ...	Auflistungen ohne festgelegte Reihenfolge
[Taster]	Bedienelemente (zum Beispiel: Taster, Schalter)
„Anzeige“	Anzeigeelemente (zum Beispiel: Signalleuchten, Bildelemente)

2 Sicherheit

2.1 Vorgesehene Zweckbestimmung

Vorgesehene Zweckbestimmung

Bei der Zentrifuge **ROTOFIX 32 A** handelt es sich um ein In-vitro-Diagnostikum gemäß der Verordnung über In-Vitro-Diagnostika (EU) 2017/746. Das Gerät dient zum Zentrifugieren sowie zur Anreicherung von Probenmaterial menschlichen Ursprungs für eine anschließende Weiterverarbeitung für diagnostische Zwecke. Der Anwender kann jeweils die veränderbaren physikalischen Parameter innerhalb der vom Gerät vorgegebenen Grenzen einstellen.

Die Zentrifuge darf nur von Fachpersonal in geschlossenen Laboratorien verwendet werden. Die Zentrifuge ist nur für den oben genannten Verwendungszweck bestimmt. Zur bestimmungsgemäßen Verwendung gehört auch das Beachten aller Hinweise aus der Gebrauchsanweisung und die Einhaltung der Inspektions- und Wartungsarbeiten. Eine andere oder darüber hinausgehende Benutzung gilt als nicht bestimmungsgemäß. Für hieraus entstehende Schäden haftet die Firma Andreas Hettich GmbH & Co. KG nicht.

Nicht vorgesehene Zweckbestimmung

- Die Zentrifuge ist nicht für den Einsatz in explosionsfähiger, in radioaktiv, in biologisch oder chemisch kontaminierter Atmosphäre geeignet.
- Bei der Zentrifugation von gefährlichen Stoffen bzw. Stoffgemischen, die toxisch, radioaktiv oder mit pathogenen Mikroorganismen verseucht sind, sind durch den Benutzer geeignete Maßnahmen zu treffen. Der Hersteller empfiehlt grundsätzlich nur Zentrifugiergefäße mit speziellen Schraubverschlüssen für gefährliche Substanzen zu verwenden. Bei Materialien der Risikogruppe 3 und 4 verschließbare Zentrifugiergefäße mit Bio-Sicherheitssystem verwenden.
- Der Hersteller empfiehlt keine Zentrifugation mit brennbaren oder explosiven Materialien.
- Der Hersteller empfiehlt keine Zentrifugation mit Materialien, die chemisch mit hoher Energie miteinander reagieren.

Vorhersehbare Fehlanwendung

Im Rahmen der Zweckbestimmung empfiehlt der Hersteller nur von ihm freigegebenes Zubehör verwenden.

Die Zentrifuge nur unter Aufsicht betreiben.

2.2 Anforderungen an das Personal

Benötigte Qualifikationen

Der Benutzer hat die Gebrauchsanweisung vollständig gelesen und sich mit dem Gerät vertraut gemacht.



HINWEIS

Beschädigungen am Gerät durch unautorisiertes Personal

- Eingriffe und Veränderungen an Geräten durch unautorisierte Personen geschehen auf eigene Gefahr und führen zum Verlust aller Gewährleistungsansprüche und Haftungsansprüche.

Geschulter Benutzer

Der Benutzer ist im Laborbereich ausgebildet oder geschult und in der Lage, die ihm übertragenen Arbeiten auszuführen und mögliche Gefahren selbstständig zu erkennen und zu vermeiden.

Persönliche Schutzausrüstung

Fehlende oder ungeeignete persönliche Schutzausrüstung erhöht das Risiko von Gesundheitsschäden und Verletzungen.

- Nur persönliche Schutzausrüstung verwenden, die in ordnungsgemäßem Zustand ist.
- Nur persönliche Schutzausrüstung verwenden, die an die Person angepasst ist (zum Beispiel in der Größe).
- Hinweise auf weitere Schutzausrüstung bei spezifischen Tätigkeiten beachten.

2.3 Verantwortung des Betreibers



Für einen ordnungsgemäßen und sicheren Gebrauch des Geräts den Anweisungen in diesem Dokument folgen. Gebrauchsanweisung für späteres Nachschlagen aufbewahren.

Informationen bereitstellen

- Die Beachtung der Anweisungen in diesem Dokument hilft dabei:
 - Gefahrensituationen zu vermeiden.
 - Reparaturkosten und Ausfallzeiten zu minimieren.
 - Zuverlässigkeit und Lebensdauer des Geräts zu erhöhen.
- Für die Beachtung von betrieblichen Vorschriften, Normen und nationalen Gesetzen ist der Betreiber verantwortlich.
- Die Revision des Dokuments getrennt vom Dokument notieren und aufbewahren. Bei Verlust kann das Dokument in der korrekten Revision ersetzt werden.
- Die Gebrauchsanweisung am Einsatzort des Geräts verfügbar halten.
- Die Gebrauchsanweisung bei einem Verkauf des Geräts an den Käufer weitergeben.

Personal unterweisen

Durch fehlende Kenntnisse bei Arbeiten mit dem Gerät können Personen schwer verletzt oder getötet werden.

- Personal gemäß der Anweisung in seinen Aufgaben und in den damit verbundenen Risiken unterweisen.

2.4 Sicherheitshinweise



Meldungen von schwerwiegenden Ereignissen und meldepflichtigen Vorkommnissen

Bei schwerwiegenden Ereignissen oder meldepflichtigen Vorkommnissen mit dem Gerät oder dessen Zubehör, müssen diese dem Hersteller und gegebenenfalls der zuständigen Behörde in dem der Anwender und/oder der Patient niedergelassen ist, gemeldet werden.



GEFAHR

Kontaminationsgefahr für den Anwender durch ungenügende Reinigung oder bei Nichtbeachten der Reinigungsvorschriften.

- Reinigungsvorschriften beachten.
- Beim Reinigen des Geräts persönliche Schutzausrüstung tragen.
- Laborordnung (zum Beispiel TRBAs, IfSG, Hygieneplan) für den Umgang mit biologischen Agentien beachten.

**GEFAHR**

Brand- und Explosionsgefahr durch Gefahrenstoffe in Proben.

- Einschlägige Vorschriften und Richtlinien für den Umgang mit Chemikalien und Gefahrstoffen beachten.
- Keine aggressiven Chemikalien verwenden (zum Beispiel: gefährliche, korrosive Extraktionsmittel wie Chloroform, starke Säuren).

**WARNUNG**

Gefahren durch ungenügend oder nicht rechtzeitig durchgeführte Wartung.

- Wartungsintervalle befolgen.
- Gerät auf sichtbare Schäden oder Mängeln prüfen. Bei sichtbaren Schäden oder Mängeln das Gerät außer Betrieb nehmen und Servicetechniker informieren.

**! WARNUNG**

Stromschlaggefahr durch Eindringen von Wasser oder anderen Flüssigkeiten.

- Gerät vor Flüssigkeiten von außen schützen.
- Keine Flüssigkeiten in das Innere des Geräts schütten.
- Transport mit Originaltransportverpackung durchführen.

**! WARNUNG**

Kontamination mit gefährlichen Stoffen und Stoffgemischen!

Bei Stoffen und Stoffgemischen, die toxisch, radioaktiv und/oder mit pathogenen Mikroorganismen verseucht sind, folgende Maßnahmen beachten:

- Grundsätzlich nur Zentrifugiergefäße mit speziellen Schraubverschlüssen für gefährliche Substanzen verwenden.
- Bei Materialien der Risikogruppe 3 und 4 verschließbare Zentrifugiergefäße mit Bio-Sicherheitssystem verwenden.
- Ohne Verwendung eines Bio-Sicherheitssystems ist das Gerät im Sinne der Norm EN / IEC 61010-2-020 nicht mikrobiologisch dicht.
- Bei Bedarf den Hersteller kontaktieren.

**WARNUNG**

Verletzungsgefahr und Beschädigungen am Gerät durch lockeren Rotor.

- Bei der Montage des Rotors muss der Mitnehmer der Rotorwelle korrekt in der Nut des Rotors sitzen.
- Mutter zur Befestigung des Rotors handfest anziehen.
- Rotor auf festen Sitz prüfen.
- Wartungsintervalle befolgen.

VORSICHT
Verletzungsgefahr durch drehenden Rotor

Wird der Rotor manuell bewegt, können sich lange Haare und Kleidungsstücke am Rotor verfangen.

- Lange Haare zusammenbinden.
- Kleidungsstücke nicht in den Schleuderraum hängen lassen.

HINWEIS
Beschädigungen der Elektronik des Geräts durch falsche Spannung oder Frequenz am Geräteschutzschalter.

- Gerät mit korrekter Netzspannung und Netzfrequenz betreiben.
Wert ist in den technischen Daten und auf dem Typenschild zu finden.

HINWEIS
Beschädigungen am Gerät und der Proben durch vorzeitigen Programmabbruch.

Ein vorzeitiger Programmabbruch entsteht durch einen Stromausfall, das Ausschalten während des Programmablaufs oder das Ziehen des Netzsteckers.

- Gerät während des Programmablaufs nicht ausschalten.
- Gerät während des Programmablaufs nicht notentriegeln.
- Während des Programmablaufs nicht den Netzstecker ziehen.

3 Geräteübersicht

3.1 Technische Daten

Hersteller	Andreas Hettich GmbH & Co. KG, D-78532 Tuttlingen	
Modell	ROTOFIX 32 A	
Typ	1206 1206-34	1206-01 1206-33
Netzspannung ($\pm 10\%$)	208-240 V 1~	100-127 V 1~
Netzfrequenz	50-60 Hz	50-60 Hz
Anschlusswert	300 VA	300 VA
Stromaufnahme	1.4 A	3.0 A
max. Kapazität	4 x 100 ml / 32 x 15 ml	
max. zulässige Dichte	1.2 kg/dm ³	

max. Drehzahl (RPM)	6000	
max. Beschleunigung (RCF)	4226	
max. Kinetische Energie	3160 Nm	
Prüfpflicht (DGUV Regeln 100-500) (gilt nur in Deutschland)	Nein	
Umgebungsbedingungen (EN / IEC 61010-1):		
Aufstellungsort	nur in Innenräumen	
Höhe	bis zu 2000 m über Normal-Null	
Umgebungstemperatur	2 °C bis 40 °C	
Luftfeuchtigkeit	maximale relative Luftfeuchte 80 % für Temperaturen bis 31 °C, linear abnehmend bis 50 % relativer Luftfeuchte bei 40 °C.	
Überspannungskategorie (IEC 60364-4-443)	II	
Verschmutzungsgrad	2	
Geräteschutzklasse	I nicht für den Einsatz in explosionsgefährdeter Umgebung geeignet.	
EMV:		
Störaussendung, Störfestigkeit	EN / IEC 61326-1 Klasse B	FCC Class B
Geräuschpegel (rotorabhängig)	≤57 dB(A)	
Abmessungen:		
Breite	366 mm	
Tiefe	430 mm	
Höhe	257 mm	
Gewicht	ca. 23 kg	

Typenschild



Abb. 1: Typenschild

- 1 Artikelnummer
- 2 Seriennummer
- 3 Revision
- 4 Equipmentnummer
- 5 Datamatrix Code
- 6 evtl. Kennzeichnung ob Medizinprodukt oder In-vitro-Diagnostikum
- 7 Global Trade Item Number (GTIN)
- 8 Herstellungsdatum
- 9 Seriennummer
- 10 evtl. EAC-Zeichen, CE-Zeichen
- 11 Herstellungsland
- 12 Herstellungsdatum
- 13 Netzfrequenz
- 14 Maximal Kinetische Energie
- 15 Maximal zulässige Dichte
- 16 Herstelleradresse
- 17 evtl. Druck Kühlmittelkreislauf
- 18 evtl. Füllmenge Kühlmittel
- 19 evtl. Typ Kühlmittel
- 20 Umdrehungen pro Minute
- 21 Leistungswerte
- 22 Netzspannung
- 23 evtl. Gerätebezeichnung
- 24 Herstellerlogo

3.2 Europäische Registrierung

Konformität des Geräts

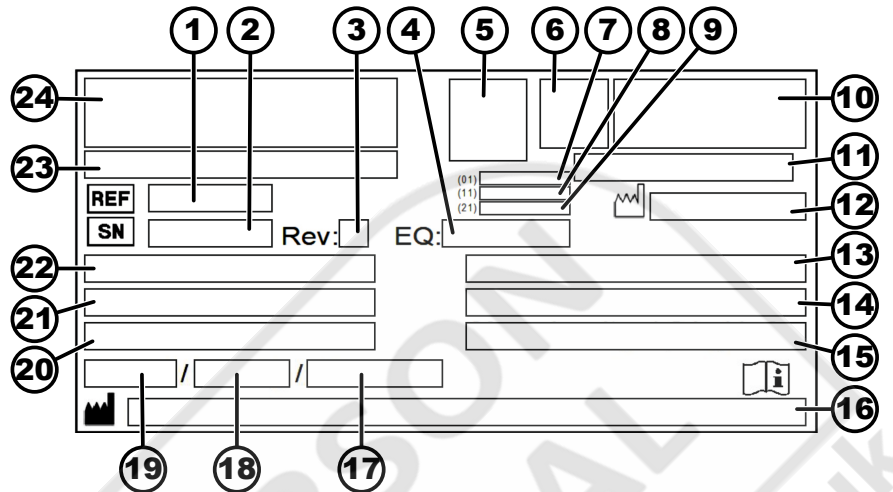
Konformität des Geräts nach EU-Richtlinien.



Single Registration Number

SRN: DE-MF-000010680

Basic-UDI-DI

Basic-UDI-DI	Gerätezuordnung
040506740100129P	ROTOFIX 32 A (In-vitro Diagnostikum)

3.3 Wichtige Schilder auf der Verpackung



OBEN

Dies ist die korrekte aufrechte Position der Versandverpackung für die Beförderung und/oder Lagerung.



ZERBRECHLICHES PACKGUT

Der Inhalt der Versandverpackung ist zerbrechlich, deshalb muss sie mit Vorsicht gehandhabt werden.



VOR NÄSSE SCHÜTZEN

Die Versandverpackung muss von Regen ferngehalten werden und in trockener Umgebung gehalten werden.

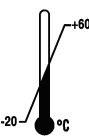

TEMPERATURBEGRENZUNG

Die Versandverpackung muss innerhalb des angezeigten Temperaturbereichs (-20 °C bis +60 °C) gelagert, transportiert und gehandhabt werden.



LUFTFEUCHTEBEGRENZUNG

Die Versandverpackung muss innerhalb des angezeigten Luftfeuchtigkeitsbereichs (10 % bis 80 %). gelagert, transportiert und gehandhabt werden.



STAPELBEGRENZUNG ANHAND DER STÜCKZAHL

Höchste Anzahl identischer Packstücke, die auf das unterste Packstück gestapelt werden darf, wobei „n“ für die Anzahl der zulässigen Packstücke steht. Das unterste Packstück ist nicht in „n“ enthalten.

3.4 Wichtige Schilder am Gerät



Die Schilder am Gerät dürfen nicht entfernt, überklebt oder abdeckt werden.



Achtung, allgemeine Gefahrenstelle.

Vor Benutzung des Gerätes unbedingt die Hinweise zur Inbetriebnahme und Bedienung lesen und die sicherheitsrelevanten Hinweise beachten!



Warnung vor Biogefährdung.



Drehrichtung des Rotors.

Die Ausrichtung des Pfeils zeigt die Drehrichtung des Rotors an.



Symbol für die getrennte Sammlung von Elektro- und Elektronikgeräten, gemäß der Richtlinie 2012/19/EU (WEEE).

Verwendung in den Ländern der Europäischen Union, in Norwegen und der Schweiz.

3.5 Bedien- und Anzeigeelemente

3.5.1 Steuerung



Abb. 2: Steuerung

3.5.2 Anzeigeelemente

Abb. 3: Anzeige „Deckel geschlossen“

Abb. 4: Anzeige „Deckel geöffnet“

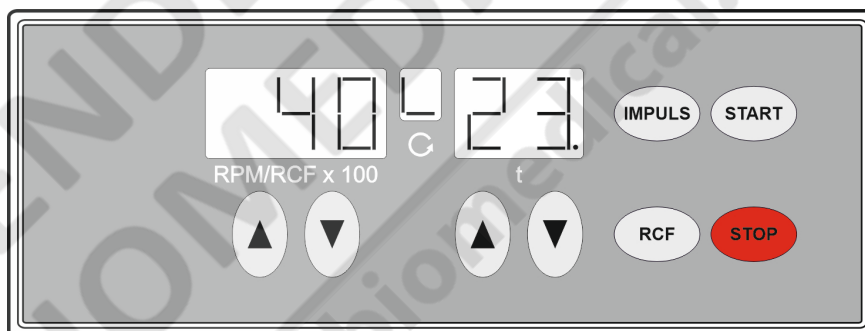

Abb. 5: Anzeige „Rotation“

3.5.3 Bedienelemente



Abb. 6: [Netzschalter]

- Anzeige erscheint, wenn der Deckel geschlossen ist.
- Blinkt abwechselnd die Anzeige „Deckel geschlossen“ und „Deckel geöffnet“, so ist eine weitere Bedienung der Zentrifuge erst nach einmaligem Öffnen des Deckels möglich.
- Anzeige erscheint, wenn der Deckel geöffnet ist.
- Anzeige leuchtet rotierend, wenn sich der Rotor dreht.

IMPULS

Abb. 7: Taste [IMPULSE]

- Kurzzeitzentrifugation. Zentrifugationslauf erfolgt, solange die Taste gedrückt wird.
- Bremsstufe und Zentrifugerradius anzeigen.

RCF

Abb. 8: Taste [RCF]

- Relative Zentrifugalbeschleunigung, Parameter RCF. Anzeige der relativen Zentrifugalbeschleunigung (RCF) erfolgt, solange die Taste gedrückt wird.

START

Abb. 9: Taste [START]

- Zentrifugationslauf starten.

STOP

Abb. 10: Taste [STOP]

- Zentrifugationslauf beenden. Der Rotor läuft mit dem vorgewählten Bremsstufe aus.
- Bremsstufe und Zentrifugerradius speichern.

RPM/RCFx100

Abb. 11: Taste [RPM/RCFx100]

- Einstellbar ist ein Zahlenwert von 500 RPM bis zur maximalen Drehzahl des Rotors. Einstellbar in 100er Schritten (RPM = angezeigter Wert x 100).
- Bremsstufe und Zentrifugerradius anzeigen.

t



Abb. 12: Taste [t]

- Laufzeit eingeben. Einstellbar von 1 bis 99 Minuten in 1 Minuten-Schritten.
- Zentrifugerradius. Eingabe in Zentimeter. Einstellbar von 5 bis 16 Zentimeter, in 1 Zentimeter-Schritten.
- Bremsstufen 0 oder 1. Stufe 1 = kurze Auslaufzeit Stufe 0 = lange Auslaufzeit.

3.6 Originalersatzteile

Nur Originalersatzteile des Herstellers und zugelassenes Zubehör verwenden.

3.7 Lieferumfang

Folgendes Zubehör wird mit der Zentrifuge geliefert:

- 1 Entriegelungsstift
- 1 Sechskant-Stiftschlüssel (SW5 x 100)
- 1 Schmierfett für die Tragzapfen
- 1 Netzkabel
- 2 Sicherungseinsätze
- 1 Gebrauchsanweisung
- 1 Hinweisblatt Transportsicherung

Rotoren und das entsprechende Zubehör werden je nach Bestellung mitgeliefert.

3.8 Rücksendung

Für eine Rücksendung muss immer ein original Rücksendformular (RMA) des Herstellers angefordert werden. Ohne ein original Rücksendformular des Herstellers ist eine sichere Warenannahme und Verbuchung der Ware beim Hersteller nicht möglich. Das Rücksendformular (RMA) enthält eine Unbedenklichkeitserklärung (UBE), die komplett ausgefüllt der Rücksendung beiliegen muss.

Wird das Gerät und/oder Zubehör an den Hersteller zurückgesendet, muss die komplette Rücksendung durch den Rücksender gereinigt und dekontaminiert werden. Falls Rücksendungen nicht oder unzureichend gereinigt und/oder unzureichend dekontaminiert sind, wird dies vom Hersteller durchgeführt und dem Versender berechnet.

Für die Rücksendung müssen die Originaltransportsicherungen befestigt werden, siehe [Kapitel 4 „Transport und Lagerung“ auf Seite 15](#). Das Gerät ist in der Originalverpackung zu versenden.

4 Transport und Lagerung

4.1 Transport- und Lagerbedingungen

Transportbedingungen



HINWEIS

Beschädigungen am Gerät durch nicht verwenden der Transportsicherungen.

- Transportsicherungen vor Transport des Geräts befestigen.



HINWEIS

Beschädigungen am Gerät durch Kondensat.

Bei einem Temperaturunterschied von kalt nach warm besteht die Gefahr, dass sich Kondensat an elektrotechnischen Bauteilen bildet. Das sich bildende Kondensat kann einen Kurzschluss verursachen oder Elektronik zerstören.

- Gerät mindestens 3 Stunden im warmen Raum aufwärmen, bevor es an das Netz angeschlossen wird. oder
- 30 Minuten im kalten Raum warmlaufen.

- Vor dem Transport die Transportsicherung befestigen und das Gerät von der Netzsteckdose trennen.
- Transporttemperatur muss zwischen -20 °C und +60 °C betragen.
- Luftfeuchtigkeit darf nicht kondensierend sein. Luftfeuchtigkeit muss zwischen 10 % und 80 % betragen.
- Gewicht des Geräts beachten.
- Beim Transport mit einer Transporthilfe (zum Beispiel Transportwagen) muss die Transporthilfe mindestens das 1,6-fache des Transportgewichts des Geräts tragen können.
- Gerät während des Transports vor Umkippen und Herunterfallen sichern.
- Gerät nie seitlich oder auf dem Kopf transportieren.

Lagerbedingungen

- Gerät muss in der Originalverpackung gelagert werden.
- Gerät nur in trockenen Räumen lagern.
- Lagertemperatur muss zwischen -20 °C und +60 °C betragen.
- Luftfeuchtigkeit darf nicht kondensierend sein. Luftfeuchtigkeit muss zwischen 10 % und 80 % betragen.

4.2 Transportsicherung befestigen

Personal:

- Geschulter Benutzer

Deckel ist geschlossen.

Netzkabel ist vom Gerät getrennt.



Abb. 13: Transportsicherung

- 1 Transportsicherung
- 2 Abstandshülse
- 3 Schrauben

1. ➔ Gerät auf die Geräterückseite kippen.
2. ➔ 3 Transportsicherungen (1) einsetzen.
3. ➔ 3 Schrauben (3) mit Abstandshülsen (2) eindrehen.

5 Inbetriebnahme

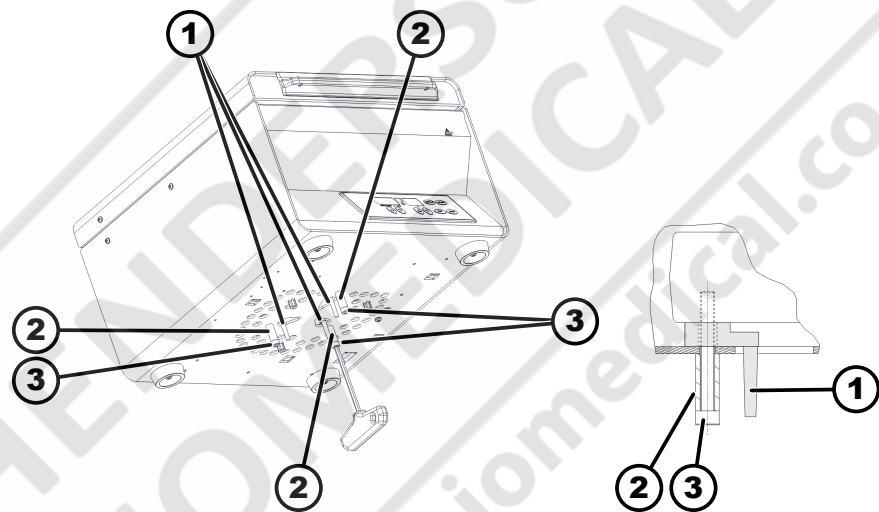
5.1 Auspacken der Zentrifuge



VORSICHT

Quetschgefahr durch herausfallende Teile aus der Transportverpackung.

- Gerät während des Auspackvorgangs im Gleichgewicht halten.
- Verpackung nur an den dafür vorgesehenen Stellen öffnen.



VORSICHT

Verletzungsgefahr durch das Heben schwerer Lasten.

- Angemessene Anzahl an Helfer bereitstellen.
- Gewicht beachten. Siehe → Kapitel 3.1 „Technische Daten“ auf Seite 9.



HINWEIS

Beschädigungen am Gerät durch nicht sachgemäßes Anheben.

- Zentrifuge nicht am Bedienteil oder am Halter des Bedienteiles anheben.

Personal:

- Geschulter Benutzer

1. > Falls vorhanden: Verpackungsbänder entfernen.
2. > Karton nach oben abheben und Polsterung entfernen.
3. > Zubehör entfernen und sicher aufbewahren.
4. > Gerät auf einen stabilen und ebenen Untergrund stellen.

5.2 Transportsicherung entfernen

Personal:

- Geschulter Benutzer

Deckel ist geschlossen.

Netzkabel ist vom Gerät getrennt.



Abb. 14: Transportsicherung

- 1 Transportsicherung
- 2 Abstandshülsen
- 3 Schrauben

1. > Gerät auf die Geräterückseite kippen.
2. > 3 Schrauben (3) mit Abstandshülsen (2) herausdrehen.
3. > 3 Transportsicherungen (1) entfernen und sicher aufbewahren.
4. > Schrauben, Abstandshülsen und Transportsicherung sicher aufbewahren.

5.3 Aufstellen und Anschließen der Zentrifuge

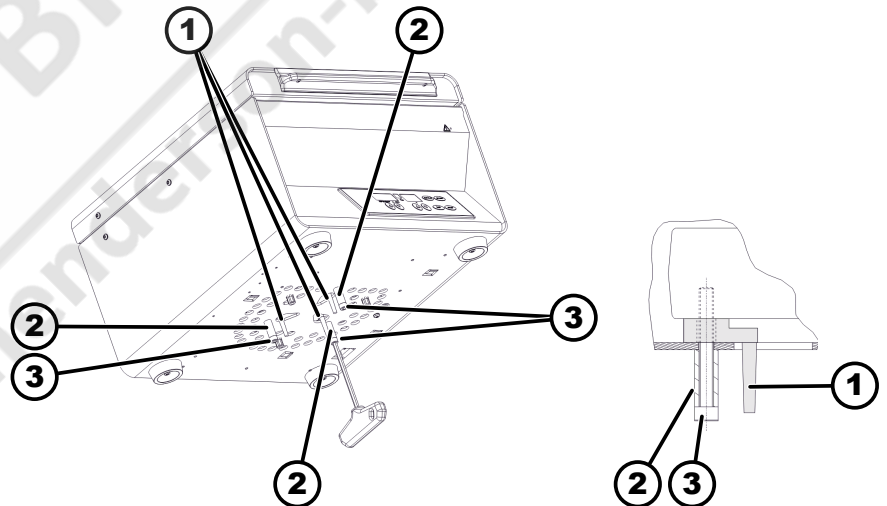
Aufstellen der Zentrifuge



WARNUNG

Verletzungsgefahr durch zu geringem Abstand zur Zentrifuge.

- Während eines Zentrifugationslaufes dürfen sich gemäß EN / IEC 61010-2-020, in einem **Sicherheitsbereich von 300 mm** um die Zentrifuge herum, keine Personen, Gefahrstoffe und Gegenstände befinden.
- Ein Abstand von **300 mm** zu den Lüftungsschlitzen und Lüftungsöffnungen der Zentrifuge ist einzuhalten.



VORSICHT

Quetschgefahr und Beschädigungen am Gerät durch Herunterfallen durch schwingungsbedingte Positionsänderungen.

- Gerät auf stabile und ebene Fläche stellen.
- Aufstellfläche entsprechend des Gewichts des Geräts wählen.



HINWEIS

Beschädigungen der Proben und des Geräts durch Über- oder Unterschreiten der maximal zulässigen Umgebungstemperatur.

- Maximal und minimal zulässige Umgebungstemperatur für die Aufstellung des Geräts beachten.
- Gerät nicht neben einer Wärmequelle aufstellen.
- Gerät nicht der direkten Sonneneinstrahlung aussetzen.
- Gerät nicht Frost aussetzen.

Personal:

- Geschulter Benutzer

1. ➤ Gerät auf einen stabilen und ebenen Untergrund stellen.
2. ➤ Um das Gerät einen Abstand von 300 mm einhalten.
3. ➤ Umgebungsbedingungen in den Technische Daten (→ Kapitel 3.1 „Technische Daten“ auf Seite 9) beachten.

Anschließen der Zentrifuge



HINWEIS

Beschädigungen am Gerät durch unautorisiertes Personal

- Eingriffe und Veränderungen an Geräten durch unautorisierte Personen geschehen auf eigene Gefahr und führen zum Verlust aller Gewährleistungsansprüche und Haftungsansprüche.



HINWEIS

Beschädigungen am Gerät durch Kondensat.

Bei einem Temperaturunterschied von kalt nach warm besteht die Gefahr, dass sich Kondensat an elektrotechnischen Bauteilen bildet. Das sich bildende Kondensat kann einen Kurzschluss verursachen oder Elektronik zerstören.

- Gerät mindestens 3 Stunden im warmen Raum aufwärmen, bevor es an das Netz angeschlossen wird. oder
- 30 Minuten im kalten Raum warmlaufen.

Personal:

- Geschulter Benutzer

1. Wenn das Gerät in der Gebäudeinstallation zusätzlich mit einem Fehlerstrom-Schutzschalter abgesichert wird, muss ein Fehlerstrom-Schutzschalter vom Typ B verwendet werden.

Bei Verwendung eines anderen Typs kann es vorkommen, dass der Fehlerstrom-Schutzschalter entweder das Gerät nicht abschaltet, wenn ein Fehler am Gerät vorliegt oder dass er das Gerät abschaltet, obwohl kein Fehler am Gerät vorliegt.

2. Prüfen, ob die Netzspannung mit der Angabe auf dem Typenschild übereinstimmt.
3. Gerät mit dem Netzkabel an eine genormte Netzsteckdose anschließen.

5.4 Zentrifuge ein- und ausschalten

Zentrifuge einschalten

Personal:

- Geschulter Benutzer

1. Netzschalter in Schalterstellung */I/* bringen.

➔ Je nach Zentrifugentyp blinken die Tasten.

Die zuletzt benutzten Zentrifugationsdaten werden angezeigt.

Rotor steht still.

1. Netzschalter in Schalterstellung */0/* bringen.

Zentrifuge ausschalten

6 Bedienung

6.1 Deckel öffnen und schließen

Deckel öffnen

Personal:

- Geschulter Benutzer

Zentrifuge ist eingeschaltet.

Rotor steht still.

1. Griffleiste am Deckel nach oben schwenken.

➔ Die Anzeige „*Deckel geöffnet*“ erscheint.

2. Deckel öffnen.

Deckel schließen

**HINWEIS**

Beschädigungen am Gerät durch das Zuschlagen des Deckels.

- Deckel langsam schließen.
- Deckel nicht zuschlagen.

Personal:

- Geschulter Benutzer

→ Deckel schließen und die Griffleiste nach unten schwenken

➔ Die Anzeige „Deckel geschlossen“ erscheint.

6.2 Rotor aus- und einbauen

Rotor mit Spannmutter ausbauen

Abb. 15: Ein- und Ausbau Rotor

- 1 Nut
- 2 Motorwelle
- 3 Mitnehmer
- 4 Bohrung

Personal:

- Geschulter Benutzer

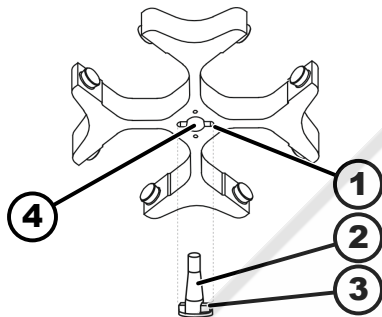
1. → Deckel öffnen.

2. → Spannmutter des Rotors mit dem mitgelieferten Schlüssel lösen.

➔ Nach Überwinden des Abhebe-Druckpunkts löst sich der Rotor vom Konus der Motorwelle (2).

3. → Spannmutter drehen, bis sich der Rotor von der Motorwelle abheben lässt.

4. → Rotor entfernen.

Rotor mit Spannmutter einbauen**Personal:**

- Geschulter Benutzer

Deckel ist geöffnet.

1. → Motorwelle (2) und Bohrung des Rotors (4) reinigen.

2. → Motorwelle (2) leicht einfetten, siehe ➔ Kapitel 8.2 „Hinweise zur Reinigung und Desinfektion“ auf Seite 30.

3. → Rotor vertikal auf die Motorwelle (2) setzen.

Mitnehmer (3) der Motorwelle muss sich in der Nut (1) des Rotors befinden. Auf dem Rotor ist die Ausrichtung der Nut gekennzeichnet.

4. → Spannmutter des Rotors mit dem mitgelieferten Schlüssel handfest anziehen.

5. → Rotor auf festen Sitz prüfen.

Rotor ohne Spannmutter ausbauen**Rotor ausbauen****Personal:**

- Geschulter Benutzer

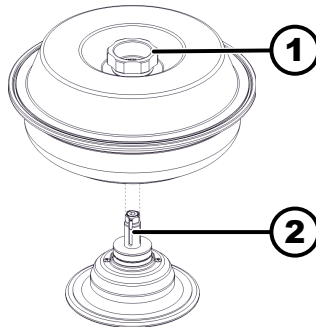

➔ Rotor am Drehgriff (1) des Deckels festhalten und von der Nabe (2) abheben.

Abb. 16: Ein- und Ausbau Rotor

- 1 Drehgriff
- 2 Nabe

Nabe ausbauen

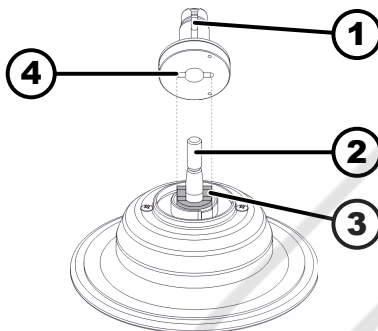

1. ➔ Deckel öffnen.
2. ➔ Spannmutter herausdrehen.
 - ➔ Nach Überwinden des Abhebe-Druckpunkts löst sich die Nabe (1) vom Konus der Motorwelle (2).
3. ➔ Nabe entfernen.

Abb. 17: Ein- und Ausbau Nabe

- 1 Nabe
- 2 Motorwelle
- 3 Mitnehmer
- 4 Nut

Rotor ohne Spannmutter einbauen

Nabe einbauen

Personal:

- Geschulter Benutzer

1. ➔ Deckel öffnen.
 2. ➔ Motorwelle (2) und Bohrung des Rotors reinigen.
 3. ➔ Motorwelle (2) leicht einfetten, siehe ➔ Kapitel 8.2 „Hinweise zur Reinigung und Desinfektion“ auf Seite 30.
 4. ➔ Nabe (1) vertikal auf die Motorwelle (2) setzen.
Mitnehmer (3) der Motorwelle muss sich in der Nut (4) der Nabe befinden.
Nabe auf festen Sitz prüfen.
 5. ➔ Spannmutter der Nabe mit dem mitgelieferten Sechskant-Stiftschlüssel handfest anziehen.
 6. ➔ Nabe auf festen Sitz prüfen.
1. ➔ Nabe (2) reinigen.
 2. ➔ Rotor am Drehgriff anheben und vertikal auf die Nabe (2) setzen.
 3. ➔ Rotor bis zum Anschlag nach unten drücken.

Rotor einbauen

6.3 Gehänge einsetzen und herausnehmen

Gehänge einsetzen



HINWEIS

Beschädigungen am Gerät durch Unwuchten entstanden durch Fehlbeladung des Rotors.

- Alle Plätze der Ausschwingrotoren mit gleichen Gehängen beladen.



Gehänge, die mit der Nummer des Rotorenplatzes gekennzeichnet sind, dürfen nur dort eingesetzt werden.

Gehänge, die mit einer Set-Nummer gekennzeichnet sind, dürfen nur zusammen verwendet werden.

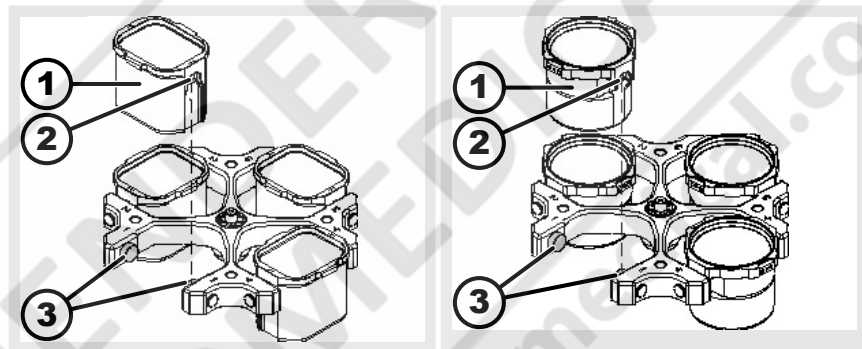

1. Rotor auf festen Sitz prüfen.
2. Tragzapfen (3) einfetten.
3. Gehänge (1) von oben in den Rotor einsetzen. Die Tragzapfen (3) müssen sich in den Nuten (2) befinden.
4. Gehänge (1) bis zum Anschlag nach unten schieben.

Gehänge herausnehmen

- ➔ Gehänge (1) senkrecht nach oben aus dem Rotor herausziehen.

6.4 Adapter einsetzen und herausnehmen

Adapter

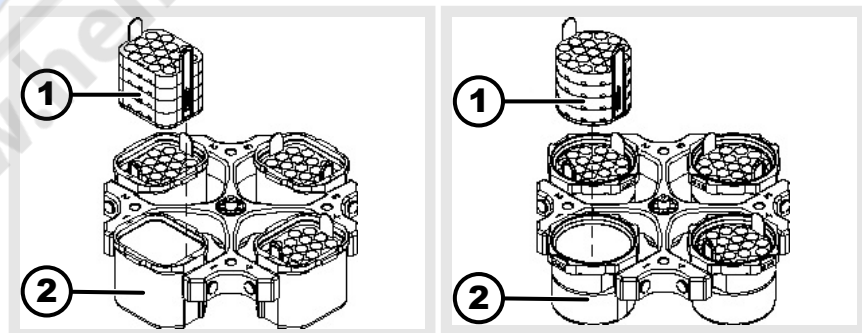

einsetzen

- ➔ Adapter (1) senkrecht von oben in die Gehänge (2) einsetzen.

herausnehmen

- ➔ Adapter (1) senkrecht nach oben aus dem Gehänge (2) herausnehmen.

Adapter mit Positionierungszapfen



Abb. 18: Adapter mit Positionierungszapfen

- 1 Adapter
- 2 Positionierungszapfen
- 3 Nut

einsetzen

- Adapter (1) in das Gehänge einsetzen
Der Positionierungszapfen (2) in muss sich in der Nut (3) des Gehänges befinden.

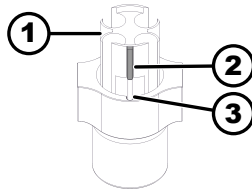
herausnehmen

- Adapter (1) senkrecht nach oben aus dem Gehänge herausnehmen.

6.5 Beladen

ZentrifugiergefäÙe befüllen



WARNUNG

Verletzungsgefahr durch kontaminiertes Probenmaterial.

Aus dem Probengefäß tritt während der Zentrifugation kontaminiertes Probenmaterial aus.

- ZentrifugiergefäÙe mit speziellen Schraubverschlüssen für gefährliche Substanzen verwenden.
- Bei Materialien der Risikogruppe 3 und 4 zusätzlich zu den verschließbaren ZentrifugiergefäÙen ein Bio-Sicherheitssystem verwenden (siehe Handbuch 'Laboratory Biosafety Manual' der WHO).



HINWEIS

Beschädigungen am Gerät durch stark korrodierende Stoffe.

Stark korrodierende Stoffe können die mechanische Festigkeit von Rotoren, Gehängen und Zubehörteilen beeinträchtigen.

- Keine stark korrodierende Stoffe zentrifugieren.



Standard-ZentrifugiergefäÙe aus Glas sind belastbar bis RZB 4000 (DIN 58970 Teil 2).

Personal:

- Geschulter Benutzer

- ➔ Zentrifugiergefäße außerhalb der Zentrifuge befüllen.
Die vom Hersteller angegebene maximale Füllmenge der Zentrifugiergefäße darf nicht überschritten werden.
Bei Winkelrotoren dürfen die Zentrifugiergefäße nur soweit befüllt werden, dass während des Zentrifugationslaufes keine Flüssigkeit aus den Gefäßen herausgeschleudert werden kann.
Um die Gewichtsunterschiede innerhalb der Zentrifugiergefäße möglichst gering zu halten, ist auf eine gleichmäßige Füllhöhe in den Gefäßen zu achten.

Ausschwingrotoren beladen

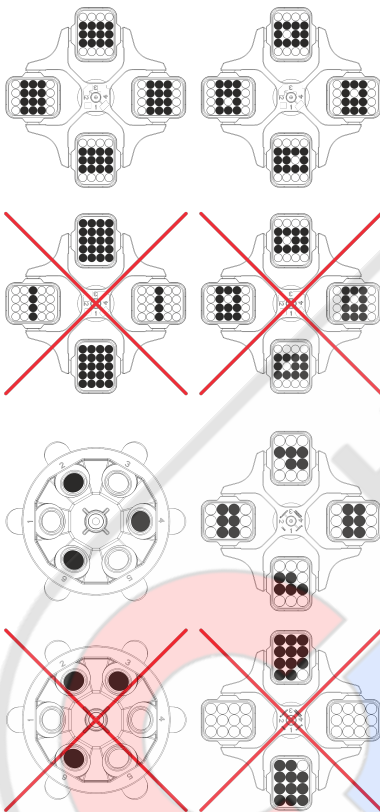

Personal:

- Geschulter Benutzer

1. ➔ Rotor auf festen Sitz prüfen.
2. ➔ Die Zentrifugiergefäße müssen symmetrisch und gleichmäßig auf alle Plätze des Rotors verteilt werden.

Auf jedem Rotor ist das Gewicht der zulässigen Füllmenge angegeben. Das Gewicht darf nicht überschritten werden.

Beim Beladen der Gehänge und beim Ausschwingen der Gehänge während des Zentrifugationslaufes darf keine Flüssigkeit in die Gehänge und in den Schleuderraum gelangen.

Bei Behältern mit Gummieinlagen muss sich unter den Zentrifugiergefäßen immer die gleiche Anzahl von Gummieinlagen befinden.

Alle Plätze des Rotors müssen mit gleichen Gehängen besetzt sein. Bestimmte Gehänge sind mit der Nummer des Rotorplatzes gekennzeichnet. Die Gehänge dürfen nur in den entsprechenden Platz des Rotors eingesetzt werden.

Gehänge, die mit einer Set-Nummer gekennzeichnet sind (zum Beispiel S001/4), dürfen nur im Set verwendet werden.

Winkelrotoren beladen

Personal:

- Geschulter Benutzer

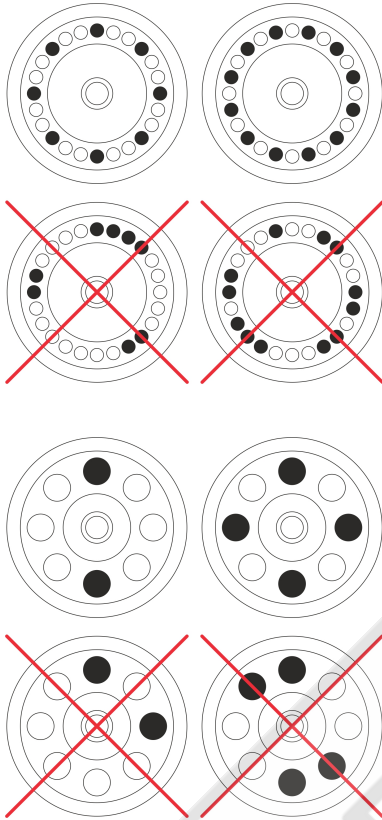

1. ▶ Rotor auf festen Sitz prüfen.
2. ▶ Die Zentrifugiergefäße müssen gleichmäßig auf alle Plätze des Rotors verteilt werden.

Beim Beladen des Rotors darf keine Flüssigkeit in den Rotor und in den Schleuderraum gelangen.

Bei Rotoren dürfen die Zentrifugiergefäße nur soweit befüllt werden, dass während des Zentrifugationslaufes keine Flüssigkeit aus den Gefäßen herausgeschleudert werden kann.

Auf jedem Rotor ist das Gewicht der zulässigen Füllmenge angegeben. Das Gewicht darf nicht überschritten werden.

6.6 BIO-Sicherheitssystem öffnen und schließen

6.6.1 Erläuterung

Bei der Zentrifugation von gefährlichen Stoffen bzw. Stoffgemischen, die toxisch, radioaktiv oder mit pathogenen Mikroorganismen verseucht sind, sind durch den Benutzer geeignete Maßnahmen zu treffen.

Es müssen grundsätzlich Zentrifugiergefäße mit speziellen Schraubverschlüssen für gefährliche Substanzen verwendet werden.

Bei Materialien der Risikogruppe 3 und 4 ist zusätzlich zu den verschließbaren Zentrifugiergefäßen ein Bio-Sicherheitssystem zu verwenden (siehe Handbuch "Laboratory Bio-safety Manual" der Weltgesundheitsorganisation).

Bei einem Bio-Sicherheitssystem verhindert eine Bioabdichtung (Dichtungsring) das Austreten von Tröpfchen und Aerosolen.

Wird das Gehänge eines Bio-Sicherheitssystems ohne den Deckel verwendet, muss der Dichtungsring vom Gehänge entfernt werden, um eine Beschädigung des Dichtungsringes während des Zentrifugationslaufes zu vermeiden.

Beschädigte Bio-Sicherheitssysteme sind nicht mehr mikrobiologisch dicht.

Ohne Verwendung eines Bio-Sicherheitssystems ist eine Zentrifuge im Sinne der Norm EN / IEC 61010-2-020 nicht mikrobiologisch dicht.

Lagerung von Bio-Sicherheitssystemen

Um eine Beschädigung der Dichtringe während der Lagerung zu vermeiden, dürfen Bio-Sicherheitssysteme nur mit geöffnetem Deckel gelagert werden.

6.6.2 Deckel mit Schraubverschluss



Abb. 19: BIO-Sicherheitssystem

- 1 Deckel
- 2 Gehänge

Schließen

1. Deckel (1) mittig auf das Gehänge (2) aufsetzen.
2. Deckel (1) im Uhrzeigersinn drehen bis dieser fest verschlossen ist.

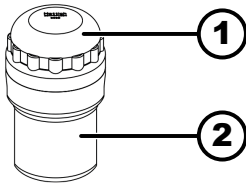
Öffnen

1. Deckel (1) gegen Uhrzeigersinn drehen bis dieser offen ist.
2. Deckel (1) vom Gehänge (2) entfernen.

6.7 Zentrifugation

6.7.1 Zentrifugation im Dauerlauf

Personal:

- Geschulter Benutzer

1. Mit den Tasten $[RPM/RCF \times 100]$ die gewünschte Drehzahl einstellen.
2. Mit den Tasten $[t]$ die Zeit auf Null stellen.
 - ➔ Es wird „--““ angezeigt.
3. Taste $[START]$ drücken.
 - ➔ Zentrifugationslauf wird gestartet.

Anzeige „Rotation“ leuchtet rotierend solange sich der Rotor dreht.

Die Zeitählung beginnt bei 0. Die erste Minute wird in Sekunden hochgezählt, danach wird die Zeit in Minuten angezeigt. Wird die Zeit in Minuten angezeigt, blinkt neben der Zahl ein Punkt.

Während des Zentrifugationslaufes werden die Drehzahl des Rotors oder der daraus resultierende RCF-Wert, und die gelaufene Zeit angezeigt.

4. Taste $[STOP]$ drücken, um den Zentrifugationslauf abubrechen.
Auslauf erfolgt mit der eingestellten Bremsstufe. Bremsstufe wird angezeigt.

Bei Stillstand des Rotors ertönt ein akustisches Signal.

6.7.2 Zentrifugation mit Zeitvorwahl

Personal:

- Geschulter Benutzer

1. Mit den Tasten $[RPM/RCF \times 100]$ die gewünschte Drehzahl einstellen.
2. Mit den Tasten $[t]$ die gewünschte Zeit einstellen.

3.  Taste *[START]* drücken.
 - Zentrifugationslauf wird gestartet.



Anzeige „*Rotation*“ leuchtet rotierend solange sich der Rotor dreht. Die Zeit wird in Minuten angezeigt. Die letzte Minute wird in Sekunden heruntergezählt. Wird die Zeit in Minuten angezeigt, blinkt neben der Zahl ein Punkt.

Während des Zentrifugationslaufs werden die Drehzahl des Rotors oder der daraus resultierende RCF-Wert, und die verbleibende Zeit angezeigt.
4.  Nach Ablauf der Zeit oder bei Abbruch des Zentrifugationslaufs durch Drücken der Taste *[STOP]* erfolgt der Auslauf mit der angewählten Bremsstufe.

Bei Stillstand des Rotors es ertönt ein akustisches Signal.

6.7.3 Kurzzeitzentrifugation

Personal:

- Geschulter Benutzer
1.  Mit den Tasten *[RPM/RCF x 100]* die gewünschte Drehzahl einstellen.
 2.  Taste *[IMPULSE]* drücken und gedrückt halten.
 - Zentrifugationslauf wird gestartet.

Anzeige „*Rotation*“ leuchtet rotierend solange sich der Rotor dreht. Die Zeitählung beginnt bei 0. Die erste Minute wird in Sekunden hochgezählt, danach wird die Zeit in Minuten angezeigt. Wird die Zeit in Minuten angezeigt, blinkt neben der Zahl ein Punkt.





Während des Zentrifugationslaufes werden die Drehzahl des Rotors und die gelaufene Zeit angezeigt.
 3.  Taste *[IMPULSE]* loslassen, um den Zentrifugationslauf zu beenden.
 - Auslauf erfolgt mit der eingestellten Bremsstufe. Bremsstufe wird angezeigt.

Bei Stillstand des Rotors ertönt ein akustisches Signal.

7 Softwarebedienung



7.1 Zentrifugationsparameter

7.1.1 Bremsstufe einstellen

1.  Netzschalter ausschalten.
2.  Taste  *[RPM/RCF x 100]* und Taste *[IMPULSE]* gleichzeitig drücken und gedrückt halten.
3.  Netzschalter einschalten und die Tasten loslassen.
 - Taste  *[RPM/RCF x 100]* so oft drücken, bis in der Drehzahlanzeige die Maschinenversion und in der Zeitanzeige die eingestellte Bremsstufe (bzw. „0“ oder „1“) angezeigt wird.

Die Maschinenversion ist werksseitig eingestellt und kann nicht verändert werden.

Die Maschinenversion ist werksseitig eingestellt und kann nicht verändert werden.

4.  Mit den Tasten *[t]* die gewünschte Bremsstufe einstellen.
 - ➔ Stufe 1 = kurze Auslaufzeit.
 - Stufe 0 = lange Auslaufzeit.
5.  Taste *[STOP]* drücken, um die Einstellungen zu speichern.

7.1.2 Relative Zentrifugalbeschleunigung RCF

Die relative Zentrifugalbeschleunigung RCF ist von der Drehzahl und dem Zentrifugierradius abhängig.

Die relative Zentrifugalbeschleunigung RCF wird als Vielfaches der Erdbeschleunigung (g) angegeben.

Die relative Zentrifugalbeschleunigung RCF ist ein einheitsfreier Zahlenwert und dient zum Vergleich der Trenn- und Sedimentationsleistung.

$$RCF = \left(\frac{RPM}{1000} \right)^2 * r * 1,118$$



$$RPM = \sqrt{\frac{RCF}{r * 1,118}} * 1000$$

RCF = Relative Zentrifugalbeschleunigung

RPM = Drehzahl

r = Zentrifugierradius in mm = Abstand von der Mitte der Drehachse bis zum Zentrifugiergefäßboden.

Anzeige der relativen Zentrifugalbeschleunigung (RCF)

1.  Während des Zentrifugationslaufes die Taste *[RCF]* drücken und gedrückt halten.
 - ➔ Relative Zentrifugalbeschleunigung (RCF) wird angezeigt.
2.  Taste *[RCF]* loslassen.
 - ➔ Die Drehzahl wird angezeigt.

7.1.3 Zentrifugation von Stoffen oder Stoffgemischen mit einer höheren Dichte als 1,2 kg/dm³

Bei der Zentrifugation mit maximaler Drehzahl darf die Dichte der Stoffe oder Stoffgemische 1,2 kg/dm³ nicht überschreiten. Bei Stoffen oder Stoffgemischen mit einer höheren Dichte muss die Drehzahl reduziert werden. Die erlaubte Drehzahl lässt sich nach folgender Formel berechnen:

$$\text{Reduzierte Drehzahl } (n_{red}) = \sqrt{\frac{1,2}{\text{höhere Dichte (kg/dm}^3)}} * \text{maximale Drehzahl (RPM)}$$

Zum Beispiel: Maximale Drehzahl 4000 RPM, Dichte 1,6 kg/dm³

$$n_{red} = \sqrt{\frac{1,2(\text{kg/dm}^3)}{1,6(\text{kg/dm}^3)}} * 4000 \text{ RPM} = 3464 \text{ RPM}$$

Wird im Ausnahmefall die, auf dem Gehänge angegebene, maximale Beladung überschritten, muss die Drehzahl ebenfalls reduziert werden. Die erlaubte Drehzahl lässt sich nach folgender Formel berechnen:

$$\text{Reduzierte Drehzahl } (n_{red}) = \sqrt{\frac{\text{maximale Beladung (g)}}{\text{tatsächliche Beladung (g)}}} * \text{maximale Drehzahl (RPM)}$$









Zum Beispiel: Maximale Drehzahl 4000 RPM, maximale Beladung 300 g, tatsächliche Beladung 350 g

$$n_{red} = \sqrt{\frac{300 \text{ g}}{350 \text{ g}}} * 4000 \text{ RPM} = 3703 \text{ RPM}$$

Bei Unklarheiten ist Auskunft beim Hersteller einzuholen.

7.1.4 Zentrifugerradius

Der Zentrifugerradius muss in Zentimeter eingegeben werden.

1.  Netzschalter ausschalten.
2.  Taste  [RPM/RCF x 100] und Taste [IMPULSE] gleichzeitig drücken und gedrückt halten.
3.  Netzschalter einschalten und die Tasten loslassen.
4.  Taste  [RPM/RCF x 100] so oft drücken, bis der Zentrifugerradius und „rd“ angezeigt wird.
5.  Mit den Tasten [t] den gewünschte Zentrifugerradius einstellen.
6.  Taste [STOP] drücken, um die Einstellungen zu speichern.

7.2 Rotorerkennung

- Nach Start eines Zentrifugationslaufes wird eine Rotorerkennung durchgeführt.
- Wurde der Rotor gewechselt, wird der Zentrifugationslauf nach der Rotorerkennung abgebrochen. Der Rotorcode (rot) wird angezeigt.
- Wenn die maximale Drehzahl des verwendeten Rotors kleiner als die eingestellte Drehzahl ist, wird die Drehzahl auf die maximale Drehzahl des Rotors begrenzt.

7.3 Machine Menu

7.3.1 Akustisches Signal









7.3.1.1 Allgemeines

Das akustische Signal ertönt:

- nach Auftreten einer Störung im 2 s-Intervall.
- nach Beendigung des Zentrifugationslaufes und Stillstand des Rotors im 30 s-Intervall.

Durch Öffnen des Deckels oder Drücken einer beliebigen Taste wird das akustische Signal beendet.

7.3.1.2 Akustisches Signal einstellen

1.  Netzschalter ausschalten.
2.  Taste  [RPM/RCF x 100] und Taste [IMPULSE] gleichzeitig drücken und gedrückt halten.
3.  Netzschalter einschalten und die Tasten loslassen.
4.  Taste  [RPM/RCF x 100] so oft drücken, bis „BEL 1“ oder „BEL 0“ angezeigt wird.
5.  Mit den Tasten [t] unterhalb der Zeitanzeige „0“ oder „1“ einstellen.
0 = Akustisches Signal deaktiviert.
1 = Akustisches Signal aktiviert.
6.  Taste [STOP] drücken, um die Einstellungen zu speichern.

8 Reinigung und Pflege

8.1 Übersichtstabelle

Kap.	Auszuführende Arbeiten	bei Bedarf	täglich	wöchentlich	Jährlich	Seite
8	Reinigung und Pflege					30
8.3	Reinigung					31
8.3	Gerät reinigen		X			31
8.3	Bio-Sicherheitssysteme reinigen			X		31
8.3	Zubehör reinigen			X		31
8.4	Desinfektion					32
8.4	Gerät desinfizieren	X				32
8.4	Zubehör desinfizieren	X				32
8.5	Wartung					33
8.5	Gummidichtung des Schleuderraums fetten			X		33
8.5	Gummidichtung des Bio-Sicherheitssystems fetten			X		33
8.5	Tragzapfen fetten			X		33
8.5	Zubehör prüfen			X		33
8.5	Bio-Sicherheitssystem prüfen			X		33
8.5	Schleuderraum auf Schäden prüfen				X	33
8.5	Motorwelle fetten				X	33
8.5	Zubehör mit begrenzter Verwendungsdauer	X				33
8.5	Zentrifugiergefäße tauschen	X				34

8.2 Hinweise zur Reinigung und Desinfektion



GEFAHR

Kontaminationsgefahr für den Anwender durch ungenügende Reinigung oder bei Nichtbeachten der Reinigungsvorschriften.

- Reinigungsvorschriften beachten.
- Beim Reinigen des Geräts persönliche Schutzausrüstung tragen.
- Laborordnung (zum Beispiel TRBAs, IfSG, Hygieneplan) für den Umgang mit biologischen Agentien beachten.

- Das Gerät und das Zubehör dürfen nicht in Spülmaschinen gereinigt werden.
- Nur eine Handreinigung und eine Flüssig-Desinfektion durchführen.
- Die Wassertemperatur darf maximal 25 °C betragen.
- Um Korrosionserscheinungen durch Reinigungs- oder Desinfektionsmittel zu vermeiden sind die speziellen Anwendungshinweise vom Hersteller des Reinigungs- oder Desinfektionsmittels unbedingt zu beachten.

Desinfektionsmittel:

- Flächendesinfektionsmittel (kein Hände- oder Instrumentendesinfektionsmittel)
- Ethanol als alleinige Wirksubstanz.
Das Sichtfenster im Deckel des Geräts nicht mit einem Ethanol-Propanol-Gemischen desinfizieren.
- Konzentration nicht unter 30 %
- pH-Wert: 6 – 8
- Nicht korrosiv

8.3 Reinigung

Gerät reinigen

1. ➤ Deckel öffnen.
2. ➤ Gerät ausschalten und von der Spannungsversorgung trennen.
3. ➤ Zubehör entnehmen.
4. ➤ Gehäuse der Zentrifuge und den Schleuderraum mit Seife oder einem milden Reinigungsmittel und einem feuchten Tuch reinigen.
5. ➤ Nach dem Einsatz von Reinigungsmitteln, die Reste des Reinigungsmittels mit einem feuchten Tuch entfernen.
6. ➤ Flächen müssen unmittelbar nach der Reinigung getrocknet werden.
7. ➤ Bei Bildung von Kondenswasser den Schleuderraum mit einem saugfähigen Tuch trocknen.

Bio-Sicherheitssysteme reinigen

1. ➤ Bio-Sicherheitssystem mit dem Reinigungsmittel und einem feuchten Tuch reinigen.
2. ➤ Nach dem Einsatz von Reinigungsmitteln, die Reste des Reinigungsmittels mit einem feuchten Tuch entfernen.
3. ➤ Das Zubehör unmittelbar nach der Reinigung mit einem fuselfreien Tuch und mit ölfreier Druckluft trocknen. Alle Hohlräume vollständig mit ölfreier Druckluft trocknen.

Zubehör reinigen

1. ➤ Das Zubehör mit dem Reinigungsmittel und einem feuchten Tuch reinigen.
2. ➤ Nach dem Einsatz von Reinigungsmitteln, die Reste des Reinigungsmittels mit einem feuchten Tuch entfernen.
3. ➤ Das Zubehör unmittelbar nach der Reinigung mit einem fuselfreien Tuch und mit ölfreier Druckluft trocknen. Alle Hohlräume vollständig mit ölfreier Druckluft trocknen.

8.4 Desinfektion



Einer Desinfektion muss immer eine Reinigung der betreffenden Komponenten vorangegangen sein.

Siehe → Kapitel 8.3 „Reinigung“ auf Seite 31



Konzentration und Einwirkzeit des Desinfektionsmittels gemäß Herstellerangaben.

Gerät desinfizieren



VORSICHT

Verletzungsgefahr durch Eindringen von Wasser oder anderen Flüssigkeiten.

- Gerät vor Flüssigkeiten von außen schützen.
- Keine Sprühdesinfektion am Gerät durchführen.

1. → Deckel öffnen.
2. → Gerät ausschalten und von der Spannungsversorgung trennen.
3. → Zubehör entnehmen.
4. → Das Gehäuse und den Schleuderraum mit Desinfektionsmittel reinigen.
5. → Nach dem Einsatz von Desinfektionsmitteln, die Reste des Desinfektionsmittels mit einem feuchten Tuch entfernen.
6. → Die Flächen müssen unmittelbar nach der Reinigung getrocknet werden.

Zubehör desinfizieren

1. → Das Zubehör mit dem Desinfektionsmitteln desinfizieren.
2. → Alle Hohlräume luftblasenfrei mit Desinfektionsmittel benetzen.
3. → Nach dem Einsatz von Desinfektionsmitteln, die Reste des Desinfektionsmittels abtrocknen lassen oder entfernen.

Autoklavieren

Das folgende Zubehör darf bei 121 °C / 250 °F (20 min) autoklaviert werden:

- Ausschwingrotoren
- Winkelrotoren aus Aluminium
- Gehänge aus Metall
- Deckel mit Bioabdichtung
- Adapter

Über den Sterilitätsgrad kann keine Aussage gemacht werden.

Die Deckel der Rotoren und Gehänge müssen vor dem Autoklavieren abgenommen werden.

Das Autoklavieren beschleunigt den Alterungsprozess von Materialien. Es kann es Farbveränderungen verursachen. Nach dem Autoklavieren sind die Rotoren und das Zubehör visuell auf Beschädigung zu prüfen und eventuell beschädigte Teile sofort zu tauschen.

Bei Anzeichen von Rissbildung, Versprödung oder Abnutzung ist der betreffende Dichtungsring zu tauschen. Bei Deckeln mit nicht auswechselbaren Dichtungsringen muss der gesamte Deckel getauscht werden.

Um die Dichtigkeit der Bio-Sicherheitssysteme zu gewährleisten, müssen die Dichtungsringe nach dem Autoklavieren getauscht werden.

8.5 Wartung

Gummidichtung des Schleuderraums fetten

→ Dichtungsring mit einem Gummi-Pflegemittel leicht einreiben.

Gummidichtung des Bio-Sicherheitssystems fetten

→ Dichtungsring mit einem Gummi-Pflegemittel leicht einreiben.

Tragzapfen fetten

1. → Zubehör entfernen.
2. → Tragzapfen reinigen.
3. → Nach dem Einsatz von Reinigungsmitteln, die Reste des Reinigungsmittels mit einem feuchten Tuch entfernen.
4. → Tragzapfen und Nutgehänge mit Hettich Tubenfett 4051 fetten.
5. → Überschüssiges Fett im Schleuderraum muss entfernt werden.

Zubehör prüfen

1. → Zubehör sind auf Verschleiß und Korrosionsschäden zu prüfen.
2. → Rotor auf festen Sitz prüfen.

Bio-Sicherheitssystem prüfen

1. → Alle Teile des Bio-Sicherheitssystems visuell auf Beschädigung prüfen.
2. → Die korrekte Einbaulage des Dichtungsringes bzw. der Dichtungsringe des Bio-Sicherheitssystems prüfen.
3. → Die beschädigten Teile des Bio-Sicherheitssystems austauschen.
4. → Bei Anzeichen von Rissbildung, Versprödung oder Abnutzung ist der betreffende Dichtungsring sofort auszutauschen. Bei Deckeln mit nicht auswechselbaren Dichtungsringen muss der gesamte Deckel ausgetauscht werden.

Schleuderraum auf Schäden prüfen

→ Schleuderraum auf Schäden prüfen.

Motorwelle fetten

1. → Zubehör entfernen.
2. → Motorwelle reinigen.
3. → Nach dem Einsatz von Reinigungsmitteln, die Reste des Reinigungsmittels mit einem feuchten Tuch entfernen.
4. → Motorwelle und mit Hettich Tubenfett 4051 fetten.
5. → Überschüssiges Fett im Schleuderraum muss entfernt werden.

Zubehör mit begrenzter Verwendungsdauer

Die Verwendung von bestimmten Zubehör ist zeitlich begrenzt. Aus Sicherheitsgründen darf das Zubehör nicht mehr verwendet werden, wenn entweder die darauf gekennzeichnete maximal erlaubte Anzahl der Laufzyklen oder das darauf gekennzeichnete Ablaufdatum erreicht ist.

- Die maximal zulässige Anzahl der Laufzyklen oder das Ablaufdatum ist auf dem Zubehör ersichtlich.

Zentrifugiergefäße tauschen



VORSICHT

Verletzungsgefahr durch Glasbruch.

Durch Glasbruch können sich Glassplitter und kontaminierte Flüssigkeiten innerhalb der Zentrifuge befinden.

- Schnittfeste Handschuhe tragen.
- Sicherheitsbrille und Mundschutz tragen.

Bei Undichtigkeit oder nach dem Bruch von Zentrifugiergefäßen, sind zerbrochene Gefäßteile, Glassplitter und ausgelaufenes Zentrifugiergut vollständig zu entfernen. Verbleibende Glassplitter verursachen weiteren Glasbruch.

Die Gummieinlagen und die Kunststoffhülsen der Rotoren sind nach einem Glasbruch zu ersetzen.

Handelt es sich um infektiöses Material, ist eine Desinfektion durchzuführen.

9 Störungsbehebung



9.1 Fehlerbeschreibung

Lässt sich der Fehler laut Störungstabelle nicht beheben, so ist der Kundendienst zu benachrichtigen. Zentrifugentyp und Seriennummer angeben. Beide Nummern sind auf dem Typenschild der Zentrifuge ersichtlich.

Fehlerbeschreibung	Ursache	Abhilfe
keine Anzeige	Keine Spannung. Netzeingangssicherungen defekt.	<ul style="list-style-type: none"> ■ Versorgungsspannung prüfen. ■ Netzeingangssicherung prüfen. ■ Netzschalter in Schalterstellung [//] bringen.
-1-	Tachofehler. Ausfall der Drehzahlimpulse.	<ul style="list-style-type: none"> ■ Das Gerät darf nicht ausgeschaltet werden, solange die Anzeige „Rotation“ rotierend aufleuchtet. Warten bis das Symbol „Deckel geschlossen“ angezeigt wird (nach ca. 100 Sekunden) und anschließend einen NETZ-RESET durchführen.
-2-	Netzunterbrechung während des Zentrifugationslaufes. Der Zentrifugationslauf wurde nicht beendet.	<ul style="list-style-type: none"> ■ Deckel öffnen und Taste [START] betätigen. ■ Bei Bedarf: Zentrifugationslauf wiederholen.
-3-	Unwucht. Rotor ist ungleichmäßig beladen.	<ul style="list-style-type: none"> ■ Deckel öffnen. ■ Beladung des Rotors prüfen. ■ Zentrifugationslauf wiederholen.
-4-	Kommunikation. Fehler im Steuerteil oder Leistungsteil.	<ul style="list-style-type: none"> ■ NETZ-RESET durchführen.
-5-	Überlast. Motor oder Motoransteuerung defekt.	<ul style="list-style-type: none"> ■ NETZ-RESET durchführen.
-6-	Überspannung. Netzspannung außerhalb der Toleranzen.	<ul style="list-style-type: none"> ■ NETZ-RESET durchführen. ■ Netzspannung prüfen.

Fehlerbeschreibung	Ursache	Abhilfe
-7-	Überdrehzahl. Fehler im Leistungsteil.	<ul style="list-style-type: none"> ■ NETZ-RESET durchführen.
-8-	Unterspannung. Netzspannung außerhalb der Toleranzen.	<ul style="list-style-type: none"> ■ NETZ-RESET durchführen. ■ Netzspannung prüfen.
-9-	Übertemperatur. Übertemperaturschalter im Motor hat ausgelöst.	<ul style="list-style-type: none"> ■ Deckel durch Notentriegelung öffnen. ■ Motor abkühlen lassen.
Version Error	Falsche Maschinenversion eingestellt. Steuerteil springt in das Einstellmenü.	<ul style="list-style-type: none"> ■ Mit den Tasten <i>[t]</i> die Zahl 7 einstellen. ■ Taste <i>[STOP]</i> drücken, um die Einstellungen zu speichern. ■ NETZ-RESET durchführen.
keine Drehzahlanzeige. Eingestellte Maschinenversion in der Zeitanzeige.	Version Error. Falsche Maschinenversion eingestellt. Steuerteil springt in das Einstellmenü.	<ul style="list-style-type: none"> ■ Mit den Tasten <i>[t]</i> die Zahl 7 einstellen. ■ Taste <i>[STOP]</i> drücken, um die Einstellungen zu speichern. ■ NETZ-RESET durchführen.
-c-	Controller-Watchdog. Fehler im Leistungsteil.	<ul style="list-style-type: none"> ■ NETZ-RESET durchführen.
-d-	Fehler Deckelverriegelung.	<ul style="list-style-type: none"> ■ NETZ-RESET durchführen.
-E-	Kurzschluss in Steuerteil / Leistungsteil.	<ul style="list-style-type: none"> ■ NETZ-RESET durchführen.
-F-	Keine Rotorerkennung beim Start. Kein Rotor eingesetzt oder defekter Tacho.	<ul style="list-style-type: none"> ■ NETZ-RESET durchführen.
rot...	Es wurde ein neuer Rotor erkannt.	<ul style="list-style-type: none"> ■ Taste <i>[START]</i> drücken.
 Alle Segmente der Anzeige leuchten.	-	<ul style="list-style-type: none"> ■ Kundendienst benachrichtigen.

9.2 NETZ-RESET durchführen

1.  Netzschalter in Schalterstellung *[0]* bringen.
2.  10 Sekunden warten.
3.  Netzschalter in Schalterstellung *[I]* bringen.

9.3 Notentriegelung

Bei einem Stromausfall kann der Deckel nicht motorisch entriegelt werden. Eine Notentriegelung von Hand muss durchgeführt werden.



! WARNUNG

Stromschlaggefahr durch Instandhaltungs- und Wartungsarbeiten an unter Strom stehendem Gerät.

- Gerät vor Instandhaltungs- und Wartungsarbeiten vom Netz trennen.



! WARNUNG

Schnitt- und Quetschgefahr durch sich bewegenden Rotor.

- Deckel erst öffnen, wenn der Rotor still steht.

Personal:

- Geschulter Benutzer



Abb. 20: Notentriegelung

- 1 Entriegelungsstift
- 2 Bohrung

1. Durch das Fenster im Deckel schauen, um sich zu vergewissern, dass der Rotor stillsteht.
2. Entriegelungsstift (1) waagrecht in die Bohrung (2) einführen. Soweit hineinschieben, bis sich beim nach unten Drücken des Stiftes die Griffleiste nach oben schwenken lässt.
3. Deckel öffnen.

9.4 Netzeingangssicherung tauschen

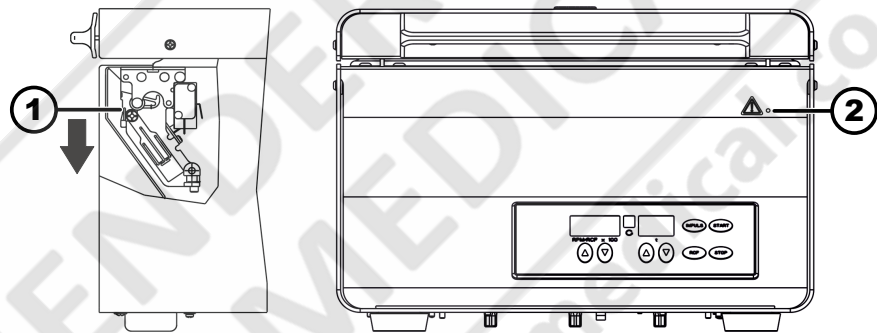

! WARNUNG

Stromschlaggefahr durch Instandhaltungs- und Wartungsarbeiten an unter Strom stehendem Gerät.

- Gerät vor Instandhaltungs- und Wartungsarbeiten vom Netz trennen.

Personal:

- Geschulter Benutzer



Abb. 21: Netzeingangssicherung

- 1 Sicherungshalter
- 2 Schnappverschluss

Die Netzsicherungen befinden sich neben dem Netzschalter.

Netzschalter befindet sich in Schalterstellung [O]

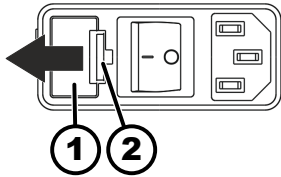
1. Netzkabel aus dem Gerätestecker ziehen.
2. Schnappverschluss (2) gegen den Sicherungshalter (1) drücken und diesen herausziehen.
3. Defekte Netzeingangssicherungen tauschen.
Nur Sicherungen mit dem, für den Typ, festgelegten Nennwert verwenden, siehe nachfolgende Tabelle.
4. Sicherungshalter (1) einschieben bis der Schnappverschluss einrastet.
5. Gerät wieder ans Netz anschließen.

Modell	Typ	Sicherung	Best.-Nr.
ROTOFIX 32 A	1206, 1206-34	T 3,15 AH/250 V	E997
ROTOFIX 32 A	1206-01, 1206-33	T 5 AH/250 V	E914

10 Entsorgung

10.1 Allgemeine Hinweise



Das Gerät kann über den Hersteller entsorgt werden.

Für eine Rücksendung muss immer ein Rücksendeformular (RMA) angefordert werden.

Bei Bedarf den technischen Service des Herstellers kontaktieren.

- **Andreas Hettich GmbH & Co. KG**
- Föhrenstraße 12
- 78532 Tuttlingen, Germany
- Telefon: +49 7461 705 1400
- E-Mail: service@hettichlab.com



! WARNUNG

Verschmutzungs- und Kontaminationsgefahr für Mensch und Umwelt

Bei der Entsorgung der Zentrifuge können Mensch und Umwelt durch falsche oder unsachgemäße Entsorgung verschmutzt oder kontaminiert werden.

- Demontage und Entsorgung darf nur durch eine geschulte und autorisierte Servicefachkraft durchgeführt werden.

Das Gerät ist für den gewerblichen Bereich ("Business to Business" - B2B) vorgesehen.

Gemäß der Richtlinie 2012/19/EU dürfen die Geräte nicht mehr mit dem Hausmüll entsorgt werden.

Die Geräte sind nach der Stiftung Elektro-Altgeräte Register (EAR) zu den folgenden Gruppen zugeordnet:



Abb. 22: Hausmüllverbot

- Gruppe 5 (Kleingeräte)

Mit dem Symbol der durchgestrichenen Abfalltonne wird darauf hingewiesen, dass das Gerät nicht mit dem Hausmüll entsorgt werden darf. Die Entsorgungsvorschriften der einzelnen Länder können unterschiedlich sein. Im Bedarfsfall an den Lieferanten wenden.



11 Index

A

Akustisches Signal.	29
Allgemeine Sicherheitshinweise.	7
Anschließen der Zentrifuge.	18
Aufstellen der Zentrifuge.	18
Auspacken.	16
Ausschalten.	19
Autoklavieren.	32

B

Befüllen.	23
Beladen.	23
Bio-Sicherheitssystem	
prüfen.	33
reinigen.	31

D

Dauerlauf.	26
Deckel	
öffnen.	19
schließen.	20
Desinfektion.	32

E

Einschalten.	19
Entsorgung.	37
Ersatzteile.	14

F

Fehlermeldungen.	34
-----------------------	----

G

Gerät	
desinfizieren.	32
reinigen.	31
Gummidichtung	
fetten.	33

K

Kurzzeitzentrifugation.	27
------------------------------	----

L

Lagerbedingungen.	16
Lieferumfang.	14

M

Motorwelle	
fetten.	33

N

NETZ-RESET.	35
Nicht vorgesehene Zweckbestimmung.	6

O

Originalersatzteile.	14
---------------------------	----

P

Personalqualifikationen.	6
Personalunterweisung.	7
Persönliche Schutzausrüstung.	6

Pflege	
Intervalle.	30

Q

Qualifikation des Personals.	6
-----------------------------------	---

R

Reinigung.	31
Reinigung und Desinfektion	
Hinweise.	30
Relative Zentrifugalbeschleunigung	
RCF.	28

Rotor

ausbauen.	20
beladen.	24
einbauen.	20
Rotorerkennung.	29
Rücksendung.	15

S

Schilder	
am Gerät.	12
auf der Verpackung.	12
Schleuderraum	
prüfen.	33
Schutzausrüstung.	6
Sicherheitshinweise.	7
Störungsbehebung.	34
Symbole.	5

T

Tragzapfen	
fetten.	33
Transportbedingung.	15
Transportsicherung	
befestigen.	16
entfernen.	17
Trouble shooting.	34
Typenschild.	11

V

Verantwortung des Betreibers.	7
Vorgesehene Zweckbestimmung.	5
Vorhersehbare Fehlanwendung.	6

W

Wartung.	33
Intervalle.	30

Z

Zentrifugation	
im Dauerlauf.	26
mit höherer Stoffdichte.	28
mit Zeitvorwahl.	26
Zentrifugiergefäße	
tauschen.	34
Zubehör.	14
desinfizieren.	32
mit begrenzter Verwendungsdauer.	33
prüfen.	33
reinigen.	31



Operating instructions

ROTOFIX 32 A



Translation of the original operating instructions

©2023 – All rights reserved

Andreas Hettich GmbH & Co. KG

Föhrenstrasse 12

D-78532 Tuttlingen, Germany

Telephone: +49 (0)7461 705-0

Fax: +49 (0)7461 705-1125

Email: info@hettichlab.com, service@hettichlab.com

Internet: www.hettichlab.com



Table of contents

1	About this document.	5
1.1	Use of this document.	5
1.2	Gender reference.	5
1.3	Symbols and labels in this document.	5
2	Safety.	5
2.1	Intended use.	5
2.2	Personnel requirements.	6
2.3	Operator's responsibility.	7
2.4	Safety instructions.	7
3	Device overview.	9
3.1	Technical data.	9
3.2	European registration.	11
3.3	Important labels on the packaging.	12
3.4	Important labels on the device.	12
3.5	Operating and indicator elements.	13
3.5.1	Control.	13
3.5.2	Indicator elements.	13
3.5.3	Controls.	14
3.6	Original spare parts.	14
3.7	Scope of delivery.	14
3.8	Returns.	15
4	Transport and storage.	15
4.1	Transport and storage conditions.	15
4.2	Fastening the transport lock.	16
5	Commissioning.	17
5.1	Unpacking the centrifuge.	17
5.2	Removing the transport lock.	17
5.3	Setting up and connecting the centrifuge.	18
5.4	Switching the centrifuge on and off.	20
6	Operation	20
6.1	Opening and closing the lid.	20
6.2	Removing and installing the rotor.	20
6.3	Inserting and removing buckets.	22
6.4	Inserting and removing adapters.	23
6.5	Loading.	24
6.6	Opening and closing the biosafety system.	26
6.6.1	Explanation.	26
6.6.2	Lid with screw cap.	26
6.7	Centrifugation.	26
6.7.1	Centrifugation in continuous operation.	26
6.7.2	Centrifugation with time preselection.	27
6.7.3	Short-time centrifugation.	27

7	Software operation	28
7.1	Centrifugation parameters	28
7.1.1	Set the brake level	28
7.1.2	Relative centrifugal force, RCF	28
7.1.3	Centrifugation of substances or mixtures of substances with a density higher than 1.2 kg/dm ³	28
7.1.4	Centrifuging radius	29
7.2	Rotor detection	29
7.3	Machine Menu	29
7.3.1	Audible signal	29
7.3.1.1	General	29
7.3.1.2	Setting an audible signal	30
8	Cleaning and care	30
8.1	Overview table	30
8.2	Instructions for cleaning and disinfection	31
8.3	Cleaning	31
8.4	Disinfection	32
8.5	Maintenance	33
9	Troubleshooting	34
9.1	Fault description	34
9.2	Performing a MAINS RESET	35
9.3	Emergency release	35
9.4	Replacing the mains input fuse	36
10	Disposal	37
10.1	General instructions	37
11	Index	39

1 About this document

1.1 Use of this document

- Read this document carefully and in full before commencing initial operation of the device.
Observe other enclosed instruction sheets where necessary.
- This document constitutes part of the device and must be kept within easy reach.
- This document must be included if the device is passed on to a third party.
- The most recently updated version of this document in the available languages can be found on the manufacturer's website at: ➔ <https://www.hettichlab.com/de/download-center/>

1.2 Gender reference

The employed masculine or feminine language form is to facilitate reading. In the spirit of equal treatment, corresponding terms apply in principle to all genders and do not imply any valuation.

1.3 Symbols and labels in this document

General symbols

The following markers are used in this document to highlight instructions, results, listings, references and other elements:

Marker	Explanation
1. ➔ 2. ➔ 3. ➔ ... ➔	Step-by-step instructions
➔	Results of action steps
➔	References to sections of the document and other applicable documents
■ ... ■ ...	Listings without a fixed order
[Buttons]	Controls (for example: buttons, switches)
'Indicator'	Indicator elements (for example: signal lights, screen elements)

2 Safety

2.1 Intended use

Intended use

The centrifuge **ROTOFIX 32 A** is an in vitro diagnostic medical device in accordance with the In Vitro Diagnostic Medical Devices Regulation (EU) 2017/746. The device is used for centrifugation as well as enrichment of sample material of human origin for subsequent further processing for diagnostic purposes. The user can set each of the variable physical parameters within the limits set by the device.

The centrifuge may only be used by qualified personnel in closed laboratories. The centrifuge is only intended for the use referred to above. Intended use also includes observing all instructions in the user manual and compliance with inspection and maintenance. Any other use or use beyond this is considered improper. Andreas Hettich GmbH & Co. KG shall not be liable for any damage arising from this.

Non-intended use

- The centrifuge is not suitable for use in explosive or radioactive, or biologically or chemically-contaminated atmospheres.
- The user must take appropriate actions when centrifuging hazardous substances or mixtures of substances that are toxic, radioactive or contaminated with pathogenic microorganisms.
The manufacturer generally recommends using only centrifuge tubes with special screw caps designed for use with hazardous substances. Use sealable centrifuge tubes with a biosafety system for materials of risk groups 3 and 4.
- The manufacturer does not recommend centrifugation of flammable or explosive materials.
- The manufacturer does not recommend centrifugation of materials that react chemically with one another with high activation energy.

Foreseeable misuse

The manufacturer recommends using only accessories approved that it has approved for the intended purpose.

Only operate the centrifuge under supervision.

2.2 Personnel requirements

Required qualifications

The user has read the Operating Manual in full and familiarised themselves with the device.



NOTICE

Damage to the device by unauthorised personnel

- Tampering with and modifications to devices by unauthorised persons are at the operating organisation's own risk and will result in the loss of all warranty and liability claims.

Trained user

The user has been educated and trained in laboratory work and is able to carry out the work assigned to them, and to recognise and prevent potential hazards independently.

Personal protective equipment

Lack of personal protective equipment or unsuitable personal protective equipment increases the risk of impaired health and injury.

- Only use personal protective equipment that is in proper condition.
- Only use personal protective equipment that is adapted to the person (correct size, for example).
- Observe instructions on other protective equipment for specific activities.

2.3 Operator's responsibility



Follow the instructions in this document for proper and safe use of the device.

Keep the user manual for future reference.

Provide information

- Following the instructions in this document will help:
 - To avoid dangerous situations.
 - To minimise repair costs and downtime.
 - To increase the reliability and service life of the device.
- The operator is responsible for compliance with company regulations, standards and national laws.
- Note and keep the revision of the document separate from the document. If lost, the document can be replaced in the correct revision.
- Keep the user manual available at the place where the device is used.
- Pass the user manual on to the buyer when the device is sold.

Personnel training

Lack of knowledge when working with the device may result in serious injury or death.

- Instruct personnel on their tasks and the associated risks in accordance with the instruction.

2.4 Safety instructions



Reporting serious incidents and notifiable incidents

In the event of serious incidents or notifiable incidents involving the device or its accessories, these must be reported to the manufacturer and, where applicable, to the competent authority where the user and/or the patient is registered.



DANGER

Risk of contamination for the user due to inadequate cleaning or failure to observe the cleaning instructions.

- Observe cleaning instructions.
- Wear personal protective equipment when cleaning the device.
- Observe laboratory regulations (e.g. TRBAs, the German Protection against Infection Act, hygiene plan) for handling biological agents.



DANGER

Fire and explosion hazard due to hazardous substances in samples.

- Observe relevant regulations and directives for handling chemicals and hazardous substances.
- Do not use aggressive chemicals (for example: dangerous, corrosive extraction agents such as chloroform, strong acids).

**WARNING**

Dangers due to insufficient maintenance or maintenance not carried out on time.

- Follow maintenance intervals.
- Check the device for visible damage or defects.
If any visible damage or defects are present, take the device out of service and inform a service technician.

**! WARNING**

Risk of electric shock due to ingress of water or other liquids.

- Protect the device against external liquids.
- Do not pour any liquids into the interior of the device.
- Transport using original transport packaging.

**! WARNING**

Contamination with hazardous substances and substance mixtures!

Observe the following actions for substances and substance mixtures that are toxic, radioactive and/or contaminated with pathogenic microorganisms:

- As a rule, use only centrifuge tubes with special screw caps for hazardous substances.
- Use sealable centrifuge tubes with a biosafety system for materials of risk groups 3 and 4.
- If no biosafety system is used, the device is not micro-biologically tight in the sense of standard EN / IEC 61010-2-020.
- Contact the manufacturer if necessary.

**WARNING**

Risk of injury and damage to the device due to a loose rotor.

- The driver of the rotor shaft must be correctly seated in the groove of the rotor when mounting the rotor.
- Hand-tighten the nut securing the rotor.
- Check that the rotor is firmly seated.
- Follow maintenance intervals.

**CAUTION**

Risk of injury due to rotating rotor

Long hair and items of clothing can get caught on the rotor if the rotor is moved manually.

- Tie long hair back.
- Do not allow garments to hang in the centrifuging chamber.

NOTICE

Damage to the device electronics due to incorrect voltage or frequency at the device circuit breaker.

- Operate the device with the correct mains voltage and mains frequency.
The value can be found in the technical data and on the rating plate.

NOTICE

Damage to the device and samples due to premature program termination.

Premature program termination is caused by power failure, switching off during the program or pulling out the mains plug.

- Do not switch off the device while the program is running.
- Do not trigger the emergency release on the device while the program is running.
- Do not pull out the mains plug while the program is running.

3 Device overview

3.1 Technical data

Manufacturer	Andreas Hettich GmbH & Co. KG, D-78532 Tuttlingen	
Model	ROTOFIX 32 A	
Type	1206 1206-34	1206-01 1206-33
Mains voltage ($\pm 10\%$)	208-240 V 1~	100-127 V 1~
Mains frequency	50-60 Hz	50-60 Hz
power consumption	300 VA	300 VA
Power consumption	1.4 A	3.0 A
max. capacity	4 x 100 ml / 32 x 15 ml	
max. permissible density	1.2 kg/dm ³	
max. speed (RPM)	6000	
max. acceleration (RCF)	4226	
max. kinetic energy	3160 Nm	

Obligation to perform checks (DGUV Rules 100-500) (valid only in Germany)	No	
Ambient conditions (EN / IEC 61010-1):		
Installation site	indoors only	
Altitude	up to 2000 m above sea level	
Ambient temperature	2 °C to 40 °C	
Humidity	maximum relative humidity 80% for temperatures up to 31 °C, decreasing linearly to 50% relative humidity at 40 °C.	
Overvoltage category (IEC 60364-4-443)	II	
Pollution level	2	
Device protection class	I not suitable for use in potentially explosive atmospheres.	
EMC:		
Emitted EM interference, EM interference immunity	EN / IEC 61326-1 Class B	FCC Class B
Noise level (rotor-dependent)	≤57 dB(A)	
Dimensions:		
Width	366 mm	
Depth	430 mm	
Altitude	257 mm	
Weight	approx. 23 kg	

Rating plate

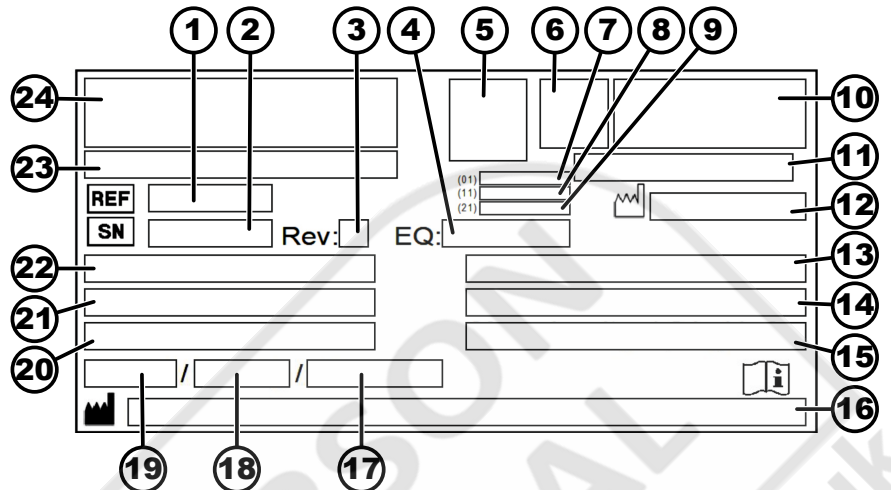

Fig. 1: Rating plate

- 1 Item number
- 2 Serial number
- 3 Revision
- 4 Equipment number
- 5 Data matrix code
- 6 any labelling indicating whether medical device or in vitro diagnostic medical device
- 7 Global Trade Item Number (GTIN)
- 8 Date of manufacture
- 9 Serial number
- 10 any EAC mark, CE mark
- 11 Country of manufacture
- 12 Date of manufacture
- 13 Mains frequency
- 14 Maximum kinetic energy
- 15 Maximum permissible density
- 16 Manufacturer's address
- 17 any Coolant circuit pressure
- 18 any Coolant capacity
- 19 any Coolant type
- 20 Revs per minute
- 21 Performance values
- 22 Mains voltage
- 23 any Device designation
- 24 Manufacturer's logo

3.2 European registration

Device conformity

Device conformity according to EU directives.



Single Registration Number

SRN: DE-MF-000010680

Basic-UDI-DI

Basic-UDI-DI	Device assignment
040506740100129P	ROTOFIX 32 A (in vitro diagnostic medical device)

3.3 Important labels on the packaging

	<p>TOP This is the correct upright position of the shipping container for transport and/or storage.</p>
	<p>FRAGILE GOODS The contents of the shipping container are fragile, so it must be handled with care.</p>
	<p>PROTECT FROM MOISTURE The shipping container must not be exposed to rain and kept in a dry environment.</p>
	<p>TEMPERATURE LIMITATION The shipping container must be stored, transported and handled within the indicated temperature range (-20 °C to +60 °C).</p>
	<p>HUMIDITY LIMITATION The shipping container must be stored, transported and handled within the indicated humidity range (10% to 80%).</p>
	<p>STACK LIMITATION BASED ON QUANTITY Maximum number of identical packages that may be stacked on the lowest package, "n" standing for the number of packages allowed. The lowest package is not included in "n".</p>

3.4 Important labels on the device



The signs on the device must not be removed or covered, or have anything pasted over them.



Attention, general danger area.

Ensure you read the instructions for commissioning and operation and observe the safety instructions before using the device.



Biohazard warning.



Direction of rotation of the rotor.

The orientation of the arrow indicates the rotor's direction of rotation.



Symbol for the separate collection of electrical and electronic equipment, in accordance with Directive 2012/19/EU (WEEE).

Use in European Union countries, Norway and Switzerland.

3.5 Operating and indicator elements

3.5.1 Control

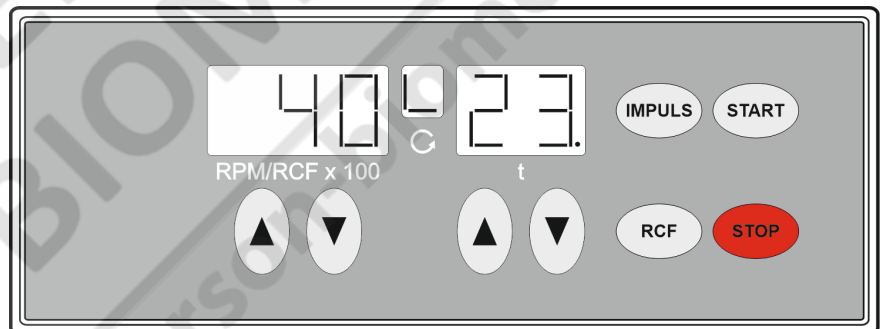

Fig. 2: Control

3.5.2 Indicator elements

Fig. 3: 'Lid closed' indicator



Fig. 4: 'Lid open' indicator



Fig. 5: 'Rotation' indicator

- The indicator appears when the lid is closed.
- If the 'Lid closed' and 'Lid open' indicators flash alternately, further operation of the centrifuge is only possible after opening the lid once.
- The indicator appears when the lid is open.
- The indicator light rotates when the rotor is turning.

3.5.3 Controls



Fig. 6: [Mains switch]



Fig. 7: [IMPULSE] button



Fig. 8: [RCF] button



Fig. 9: [START] button



Fig. 10: [STOP] button

RPM/RCF_{x100}



Fig. 11: [RPM/RCF_{x100}] button



Fig. 12: [t] button

- Switch the device on and off.
- Short-time centrifugation. The centrifugation run takes place as long as the button is being pressed.
- Display the brake level and centrifuging radius.
- Relative centrifugal force, parameter RCF. The relative centrifugal force (RCF) is displayed for as long as the button is pressed.
- Start centrifugation run.
- End the centrifugation run. The rotor ramps down to a stop at the preselected brake level.
- Save the brake level and centrifuging radius.
- A numerical value from 500 RPM to the maximum rotor speed can be set. Adjustable in increments of 100 (RPM = displayed value x 100).
- Display the brake level and centrifuging radius.
- Enter runtime. Adjustable from 1 to 99 minutes in 1 minute increments.
- Centrifuging radius. Input in centimetres. Adjustable from 5 to 16 centimetres, in 1 centimetre increments.
- Brake level 0 or 1. Level 1 = short ramp-down time Level 0 = long ramp-down time.

3.6 Original spare parts

Use only original spare parts from the manufacturer and approved accessories.

3.7 Scope of delivery

The following accessories are supplied with the centrifuge:

- 1 Release pin
- 1 hex key (SW5 x 100)
- 1 grease for the trunnions

- 1 power cable
- 2 Fuse links
- 1 user manual
- 1 instruction sheet, transport lock

Rotors and the corresponding accessories are supplied depending on the order.

3.8 Returns

An original Return Material Authorisation (RMA) form from the manufacturer must always be requested for a return. Secure and reliable acceptance and booking in of the goods with the manufacturer is not possible without an original RMA form from the manufacturer. The Return Material Authorisation (RMA) form contains a Declaration of No Objection (UBE), which must be completed in full and enclosed with the return.

If the device and/or accessories are returned to the manufacturer, the complete return shipment must be cleaned and decontaminated by the sender. If returns are not cleaned and/or decontaminated or are insufficiently cleaned and/or decontaminated, this will be performed by the manufacturer and charged to the sender.

The original transport locks must be attached for return shipment, see [Chapter 4 'Transport and storage' on page 15](#). The device must be shipped in its original packaging.

4 Transport and storage

4.1 Transport and storage conditions

Transport conditions



NOTICE

Damage to the device due to failure to use the transport locks.

- Secure the transport locks before transporting the device.



NOTICE

Damage to the device due to condensation.

There is a risk of condensation forming on electrical components when component surfaces are cold and the surrounding air is warmer. The condensation that forms may cause a short circuit and/or destroy electronics.

- Warm the device up for at least 3 hours in a warm room before connecting it to the mains.
or
- Warm up for 30 minutes in a cold room.

- Before transporting, fasten the transport lock and disconnect the device from the mains socket.
- The transport temperature must be between -20 °C and +60 °C.
- Humidity must not be condensing. Humidity must be between 10% and 80%.
- Be aware of the weight of the device.

- When transporting using a transport aid (e.g., a pallet truck), the transport aid must be able to carry at least 1.6 times the transport weight of the device.
- Secure the device to prevent it tipping over and falling down during transport.
- Never transport the device sideways or upside down.

Storage conditions

- The device must be stored in the original packaging.
- Only store the device in dry rooms.
- The storage temperature must be between -20 °C and +60 °C.
- Humidity must not be condensing. Humidity must be between 10% and 80%.

4.2 Fastening the transport lock

Personnel:

- Trained user

The lid is closed.

The mains cable is disconnected from the device.

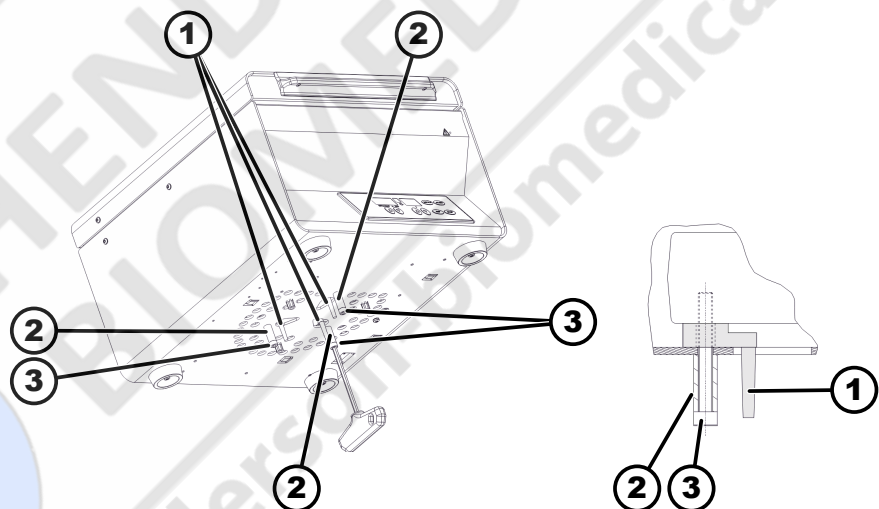

Fig. 13: Transport lock

- 1 Transport lock
- 2 Spacer sleeves
- 3 Screws

1. Tilt the device on the back of the device.
2. Insert 3 transport locks (1).
3. Screw in 3 screws (3) with spacer sleeves (2).

5 Commissioning

5.1 Unpacking the centrifuge



CAUTION

Danger of crushing due to parts falling out of the transport packaging.

- Keep the device balanced during the unpacking process.
- Only open the packaging at the points provided for this purpose.



CAUTION

Risk of injury from lifting heavy loads.

- Provide an adequate number of helpers.
- Note the weight. See → *Chapter 3.1 'Technical data' on page 9.*



NOTICE

Damage to the device due to improper lifting.

- Do not lift the centrifuge by the control panel or the control panel holder.

Personnel:

- Trained user

1. If present: Remove the packaging tapes.
2. Lift the box up and remove the padding.
3. Remove the accessories and store them safely.
4. Place the device on a stable and level surface.

5.2 Removing the transport lock

Personnel:

- Trained user

The lid is closed.

The mains cable is disconnected from the device.

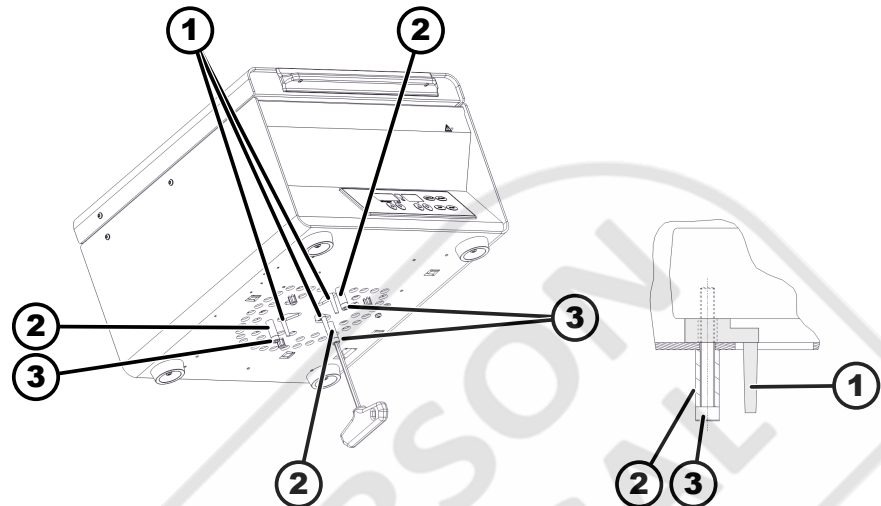

Fig. 14: Transport lock

- 1 Transport lock
- 2 Spacer sleeves
- 3 Screws

1. Tilt the device on the back of the device.
2. Unscrew 3 screws (3) with spacer sleeves (2).
3. Remove 3 transport locks (1) and store them safely.
4. Keep the screws, spacer sleeves and transport lock in a safe place.

5.3 Setting up and connecting the centrifuge

Setting up the centrifuge



WARNING

Risk of injury due to failing to maintain a sufficient distance to the centrifuge.

- As per EN / IEC 61010-2-020, no persons, hazardous materials or objects may be present within a **safety zone of 300 mm** around the centrifuge during a centrifugation run.
- A distance of **300 mm** from the ventilation slots and ventilation openings of the centrifuge must be maintained.



CAUTION

Risk of crushing and damage to the device due to it falling down because of vibration-induced position alterations.

- Place the device on a stable and level surface.
- Select the installation surface dependent on the weight of the device.



NOTICE

Damage to the samples and the device if the ambient temperature exceeds or falls below the respective maximum/minimum permissible ambient temperature.

- Comply with the maximum and minimum permissible ambient temperatures for installation of the device.
- Do not place the device next to a heat source.
- Do not expose the device to direct sunlight.
- Do not expose the device to frost.

Personnel:

- Trained user

1. Place the device on a stable and level surface.
2. Maintain a distance of 300 mm around the device.
3. Comply with the ambient conditions in the technical data (→ Chapter 3.1 'Technical data' on page 9).

Connecting the centrifuge



NOTICE

Damage to the device by unauthorised personnel

- Tampering with and modifications to devices by unauthorised persons are at the operating organisation's own risk and will result in the loss of all warranty and liability claims.



NOTICE

Damage to the device due to condensation.

There is a risk of condensation forming on electrical components when component surfaces are cold and the surrounding air is warmer. The condensation that forms may cause a short circuit and/or destroy electronics.

- Warm the device up for at least 3 hours in a warm room before connecting it to the mains.
or
- Warm up for 30 minutes in a cold room.

Personnel:

- Trained user

1. A type B residual current circuit breaker must be used if the device is additionally protected with a residual current circuit breaker in the building installation.

When using a different type, the residual current circuit breaker may either not switch off the unit if there is a fault on the unit, or it may switch off the unit even though there is no fault on the unit.

2. Check whether the mains voltage matches the specification on the rating plate.
3. Connect the device to a standard mains socket using the mains cable.

5.4 Switching the centrifuge on and off.

Switching the centrifuge on

Personnel:

- Trained user

→ Set the mains switch to [I].

- ➔ The buttons flash, depending on the centrifuge type.

The last centrifugation data used is displayed.

Switching off the centrifuge

The rotor is stationary.

→ Set the mains switch to [O].

6 Operation

6.1 Opening and closing the lid

Opening the lid

Personnel:

- Trained user

The centrifuge is switched on.

The rotor is stationary.

1. → Swivel the handle strip on the lid upwards.

- ➔ The 'Lid open' indicator appears.

2. → Open the lid.

Closing the lid

**NOTICE**

Damage to the device caused by the lid slamming.

- Close the lid slowly.
- Do not slam the lid.

Personnel:

- Trained user

→ Close the lid and swivel the handle strip downwards

- ➔ The 'Lid closed' indicator appears.

6.2 Removing and installing the rotor

Removing the rotor with a clamping nut

Personnel:

- Trained user

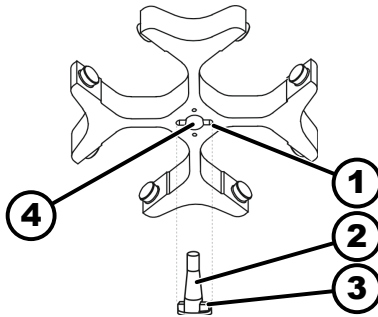

Fig. 15: Rotor installation and removal

- 1 Groove
- 2 Motor shaft
- 3 Driver
- 4 Hole

Installing the rotor with a clamping nut

1. → Open the lid.
2. → Loosen the rotor clamping nut using the supplied spanner.
 - After passing the working point for lifting the rotor, the rotor detaches from the cone of the motor shaft (2).
3. → Turn the clamping nut until the rotor can be lifted off the motor shaft.
4. → Remove the rotor.

Personnel:

- Trained user

The lid is open.

1. → Clean the motor shaft (2) and rotor hole (4).
2. → Lightly grease the motor shaft (2), see → Chapter 8.2 'Instructions for cleaning and disinfection' on page 31.
3. → Place the rotor vertically on the motor shaft (2).
The driver (3) of the motor shaft must be in the groove (1) of the rotor. The orientation of the groove is marked on the rotor.
4. → Hand-tighten the rotor clamping nut using the supplied spanner.
5. → Check that the rotor is firmly seated.

Removing the rotor without a clamping nut

Removing the rotor

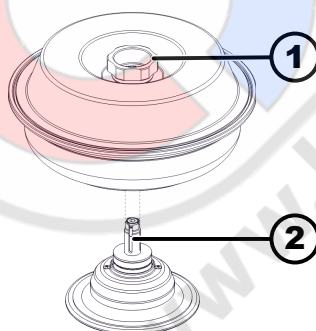

Fig. 16: Rotor installation and removal

- 1 Rotary handle
- 2 Hub

Personnel:

- Trained user

- Hold the rotor by the rotary handle (1) of the lid and lift it off the hub (2).

Removing the hub

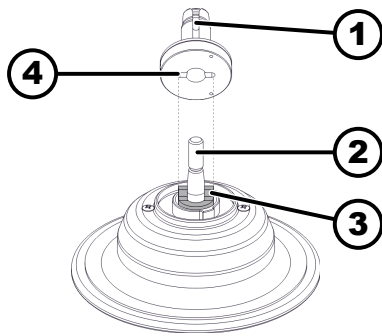

1. Open the lid.
2. Unscrew the clamping nut.
 - ➔ After passing the working point for lifting the rotor, the hub (1) detaches from the cone of the motor (2).
3. Remove the hub.

Fig. 17: Hub installation and removal

- 1 Hub
- 2 Motor shaft
- 3 Driver
- 4 Groove

Installing the rotor without a clamping nut

Installing the hub

Personnel:

- Trained user

1. Open the lid.
2. Clean the motor shaft (2) and rotor hole.
3. Lightly grease the motor shaft (2), see ➔ Chapter 8.2 'Instructions for cleaning and disinfection' on page 31.
4. Place the hub (1) vertically on the motor shaft (2).
The driver (3) of the motor shaft must be in the groove (4) of the hub.
Check that the hub is firmly seated.
5. Hand-tighten the clamping nut of the hub using the supplied hex key.
6. Check that the hub is firmly seated.

Installing the rotor

1. Clean the hub (2).
2. Lift the rotor by the rotary handle and place it vertically on the hub (2).
3. Push the rotor down as far as it will go.

6.3 Inserting and removing buckets

Inserting buckets



NOTICE

Damage to the device due to imbalances caused by incorrect loading of the rotor.

- Load all swing-out rotor locations with the same buckets.



Buckets marked with the number of the rotor location may only be used there.

Buckets marked with a set number may only be used together.

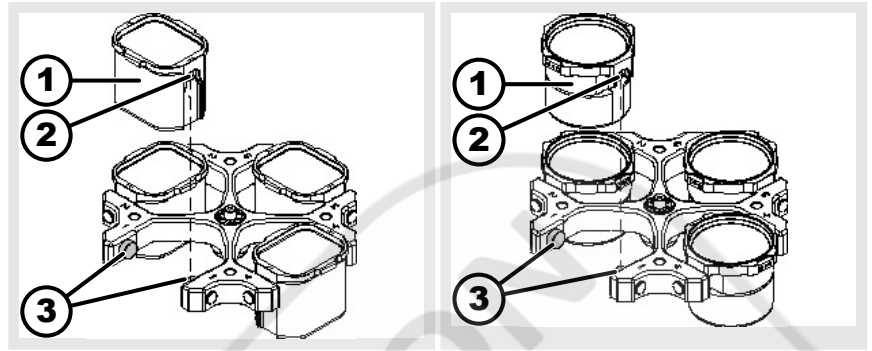

1. Check that the rotor is firmly seated.
 2. Grease the trunnions (3).
 3. Insert the bucket (1) into the rotor from above. The trunnions (3) must be in the grooves (2).
 4. Push the bucket (1) down as far as it will go.
- Pull the bucket (1) vertically upwards out of the rotor.

Removing the bucket

6.4 Inserting and removing adapters

Inserting

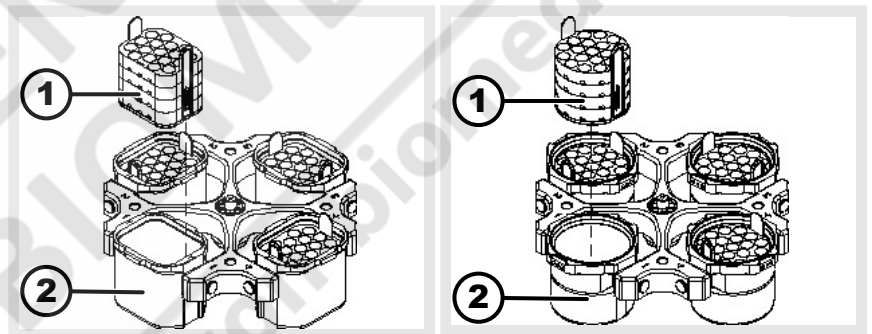

- Insert the adapter (1) vertically into the bucket (2) from above.
- Remove the adapter (1) vertically upwards out of the bucket (2).

the adapter

removing

Adapter with positioning pin

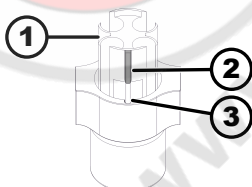

Fig. 18: Adapter with positioning pin

- 1 Inserting
- 2 Positioning pin
- 3 Inserting

the groove

- Insert the adapter (1) into the bucket
- The positioning pin (2) must be in the groove (3) of the bucket.

removing

→ Remove the adapter (1) vertically upwards out of the bucket.

6.5 Loading

Filling centrifuge tubes



WARNING

Risk of injury from contaminated sample material.

Contaminated sample material escapes from the sample tube during centrifugation.

- Use centrifuge tubes with special screw caps for hazardous substances.
- For risk group 3 and 4 materials, use a biosafety system in addition to the sealable centrifuge tubes (see WHO's 'Laboratory Biosafety Manual').



NOTICE

Damage to the device due to highly corrosive substances.

Highly corrosive substances may impair the mechanical strength of rotors, buckets and accessories.

- Do not centrifuge highly corrosive substances.



Standard glass centrifuge tubes can be loaded up to RCF 4000 (DIN 58970 part 2).

Personnel:

- Trained user

→ Fill centrifuge tubes outside the centrifuge.

The maximum capacity of the centrifuge tubes specified by the manufacturer must not be exceeded.

With angle rotors, the centrifuge tubes must only be filled to the extent that no liquid can be ejected from the tubes during the centrifugation run.

It must be ensured that there is a uniform fill level in the tubes in order to keep the weight differences in the centrifuge tubes as low as possible.

Loading swing-out rotors

Personnel:

- Trained user

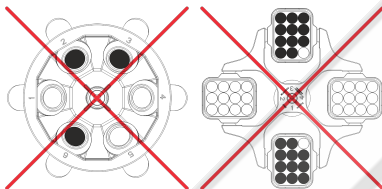
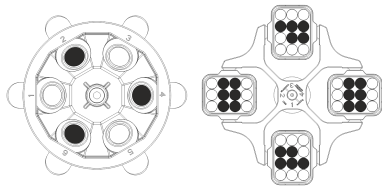
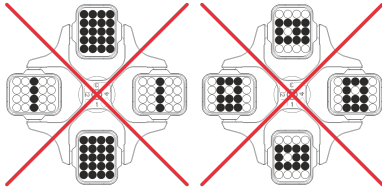
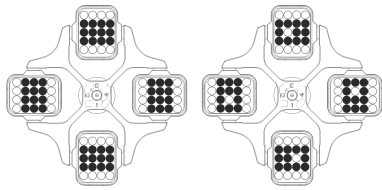

1. Check that the rotor is firmly seated.
2. The centrifuge tubes must be distributed symmetrically across all rotor locations.

The weight of the permissible filling capacity is indicated on each rotor. The weight must not be exceeded.

No liquid must be allowed to enter the buckets and the centrifuging chamber when loading the buckets and swinging them out during the centrifugation run.

For containers with rubber inserts, there must always be the same number of rubber inserts under the centrifuge tubes.

All rotor locations must be filled with the same buckets. Certain buckets are marked with the number of the rotor location. The buckets must only be inserted in the corresponding rotor location.

Buckets marked with a set number (for example S001/4) must only be used in the set.

Loading the angle rotors

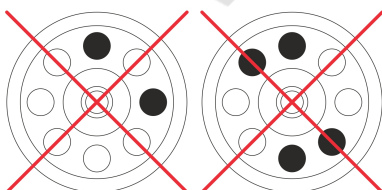
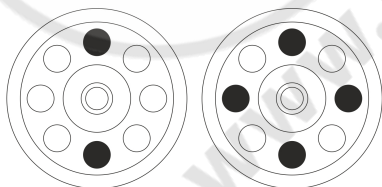
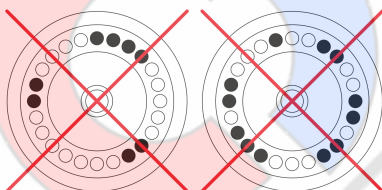
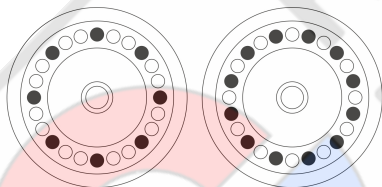

Personnel:

- Trained user

1. Check that the rotor is firmly seated.
2. The centrifuge tubes must be distributed evenly over all locations on the rotor.

No liquid must be allowed to enter the rotor and the centrifuging chamber when loading the rotor.

With rotors, the centrifuge tubes must only be filled to the extent that no liquid can be ejected from the tubes during the centrifugation run.

The weight of the permissible filling capacity is indicated on each rotor. The weight must not be exceeded.

6.6 Opening and closing the biosafety system

6.6.1 Explanation

The user must take appropriate actions when centrifuging hazardous substances or mixtures of substances that are toxic, radioactive or contaminated with pathogenic microorganisms.

Centrifuge tubes with special screw caps for hazardous substances must always be used.

For materials of risk group 3 and 4, a biosafety system must be used in addition to the sealable centrifuge tubes (see the World Health Organisation's "Laboratory Biosafety Manual").

In a biosafety system, a bioseal (sealing ring) prevents droplets and aerosols from escaping.

If the bucket of a biosafety system is used without the lid, the sealing ring must be removed from the bucket to prevent damage to the sealing ring during the centrifugation run.

Damaged biosafety systems are no longer microbiologically tight.

If no biosafety system is used, a centrifuge is not microbiologically tight in the sense of the EN / IEC 61010-2-020 standard.

Storage of biosafety systems

Biosafety systems must only be stored with the lid open to avoid damage to the sealing rings during storage.

6.6.2 Lid with screw cap

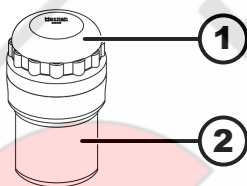

Fig. 19: Biosafety system

- 1 Lid
- 2 Bucket

Closing

1. Place the lid (1) centrally on the bucket (2).
2. Turn the lid (1) clockwise until it is tightly closed.

Opening

1. Turn the lid (1) anticlockwise until it is open.
2. Remove the lid (1) from the bucket (2).

6.7 Centrifugation

6.7.1 Centrifugation in continuous operation

Personnel:

- Trained user

1. Use the $[RPM/RCF \times 100]$ buttons to set the desired speed.
2. Use the $[t]$ buttons to set the time to zero.
 - ➔ "--" is displayed.

3.  Press the *[START]* button.
 - The centrifugation run is started.

The 'Rotation' indicator light rotates while the rotor is turning.

Timing starts at 0. The first minute is counted up in seconds, then the time is displayed in minutes. A dot flashes next to the number if the time is displayed in minutes.The rotor speed or the resulting RCF value and the elapsed time are displayed during the centrifugation run.
4.  Press the *[STOP]* button to cancel the centrifugation run.



Ramp-down takes place with the set brake level. The brake level is displayed.

An audible signal sounds when the rotor comes to a standstill.

6.7.2 Centrifugation with time preselection

Personnel:

- Trained user

1.  Use the *[RPM/RCF x 100]* buttons to set the desired speed.
2.  Use the *[t]* buttons to set the desired time.
3.  Press the *[START]* button.
 - The centrifugation run is started.

The 'Rotation' indicator light rotates while the rotor is turning.



The time is displayed in minutes. The last minute is counted down in seconds. A dot flashes next to the number if the time is displayed in minutes.The rotor speed or the resulting RCF value and the remaining time are displayed during the centrifugation run.
4.  Ramp-down takes place with the selected brake level after the time has elapsed or if the centrifugation run is cancelled by pressing the *[STOP]* button.

An audible signal sounds when the rotor comes to a standstill.

6.7.3 Short-time centrifugation

Personnel:

- Trained user

1.  Use the *[RPM/RCF x 100]* buttons to set the desired speed.
2.  Press and hold the *[IMPULSE]* button.
 - The centrifugation run is started.







The 'Rotation' indicator light rotates while the rotor is turning.

Timing starts at 0. The first minute is counted up in seconds, then the time is displayed in minutes. A dot flashes next to the number if the time is displayed in minutes.The rotor speed and the elapsed time are displayed during the centrifugation run.
3.  Release the *[IMPULSE]* button to end the centrifugation run.
 - Ramp-down takes place with the set brake level. The brake level is displayed.An audible signal sounds when the rotor comes to a standstill.

7 Software operation

7.1 Centrifugation parameters

7.1.1 Set the brake level

1.  Switch off the mains switch.
2.  Press and hold down the  *[RPM/RCF x 100]* button and the *[IMPULSE]* button simultaneously.
3.  Switch on the mains switch and release the buttons.
 - Press the  *[RPM/RCF x 100]* button repeatedly until the speed indicator shows the machine version and the time indicator shows the brake level set (and/or '0' or '1').
The machine version is set ex works and cannot be changed.
The machine version is set ex works and cannot be changed.
4.  Use the *[t]* buttons to set the desired brake level.
 - Level 1 = short ramp-down time.
Level 0 = long ramp-down time.
5.  Press the *[STOP]* button to save the settings.

7.1.2 Relative centrifugal force, RCF

The relative centrifugal force RCF is dependent on the speed and the centrifuging radius.

The relative centrifugal force RCF is stated as a multiple of the acceleration due to gravity (g).

The relative centrifugal force RCF is a dimensionless numerical value and is used to compare the separation and sedimentation performance.

$$RCF = \left(\frac{RPM}{1000} \right)^2 * r * 1,118$$



$$RPM = \sqrt{\frac{RCF}{r * 1,118}} * 1000$$

RCF = Relative Centrifugal Force

RPM = speed

r = centrifuging radius in mm = distance from the centre of the axis of rotation to the bottom of the centrifuge tube.

Display of the relative centrifugal force (RCF)

1.  Press and hold the *[RCF]* button during the centrifugation run.
 - Relative centrifugal force (RCF) is displayed.
2.  Release the *[RCF]* button.
 - The speed is displayed.

7.1.3 Centrifugation of substances or mixtures of substances with a density higher than 1.2 kg/dm³

The density of the substances or mixtures of substances must not exceed 1.2 kg/dm³ during centrifugation at maximum speed. The speed must be reduced for substances or substance mixtures with a higher density. The permissible speed can be calculated using the following formula:

$$\text{Reduced speed } (n_{red}) = \sqrt{\frac{1,2}{\text{Greater density [kg/dm}^3]}} * \text{maximum speed [RPM]}$$

For example: Maximum speed 4000 RPM, density 1.6 kg/dm³

$$n_{red} = \sqrt{\frac{1,2(\text{kg/dm}^3)}{1,6(\text{kg/dm}^3)}} * 4000 \text{ RPM} = 3464 \text{ RPM}$$

If, in exceptional cases, the maximum load indicated on the bucket is exceeded, the speed must also be reduced. The permissible speed can be calculated using the following formula:

$$\text{Reduced speed } (n_{red}) = \sqrt{\frac{\text{maximum load [g]}}{\text{actual load [g]}}} * \text{maximum speed [RPM]}$$









For example: Maximum speed 4000 RPM, maximum load 300 g, actual load 350 g

$$n_{red} = \sqrt{\frac{300 \text{ g}}{350 \text{ g}}} * 4000 \text{ RPM} = 3703 \text{ RPM}$$

Please contact the manufacturer if you are not sure.

7.1.4 Centrifuging radius

The centrifuging radius must be entered in centimetres.

1.  Switch off the mains switch.
2.  Press and hold down the  *[RPM/RCF x 100]* button and the *[IMPULSE]* button simultaneously.
3.  Switch on the mains switch and release the buttons.
4.  Press the  *[RPM/RCF x 100]* button repeatedly until the centrifuging radius and 'rd' are displayed.
5.  Use the *[t]* buttons to set the desired centrifuging radius.
6.  Press the *[STOP]* button to save the settings.

7.2 Rotor detection

- Rotor detection is performed after starting a centrifugation run.
- If the rotor has been changed, the centrifugation run is cancelled after rotor detection. The rotor code (red) is displayed.
- If the maximum speed of the rotor used is less than the set speed, the speed is limited to the maximum rotor speed.

7.3 Machine Menu

7.3.1 Audible signal

7.3.1.1 General

The audible signal sounds:

- after a problem occurs in the 2 s interval.
- after completion of the centrifugation run and rotor standstill in the 30 s interval.

Opening the lid or pressing any button stops the audible signal.

7.3.1.2 Setting an audible signal

1. Switch off the mains switch.
2. Press and hold down the ▲ [RPM/RCF x 100] button and the [IMPULSE] button simultaneously.
3. Switch on the mains switch and release the buttons.
4. Press the ▲ [RPM/RCF x 100] button repeatedly until 'BEL 1' or 'BEL 0' is displayed.
5. Use the [t] buttons beneath the time indicator to set '0' or '1'.
0 = audible signal disabled.
1 = audible signal enabled.
6. Press the [STOP] button to save the settings.

8 Cleaning and care

8.1 Overview table

Chap.	Task to execute	if required	daily	weekly	Annually	Page
8	Cleaning and care					30
8.3	Cleaning					31
8.3	Cleaning the device		X			31
8.3	Cleaning biosafety systems			X		31
8.3	Cleaning accessories			X		32
8.4	Disinfection					32
8.4	Disinfecting the device	X				32
8.4	Disinfecting the accessories	X				32
8.5	Maintenance					33
8.5	Greasing the rubber seal of the centrifuging chamber			X		33
8.5	Greasing the rubber seal of the biosafety system			X		33
8.5	Trunnion greasing			X		33
8.5	Checking the accessories			X		33
8.5	Checking the biosafety system			X		33
8.5	Centrifuging chamber damage inspection				X	33
8.5	Greasing the motor shaft				X	33
8.5	Accessories with a limited service life	X				33

Chap.	Task to execute	if required	daily	weekly	Annually	Page
8.5	Replacing centrifuge tubes	X				34

8.2 Instructions for cleaning and disinfection



DANGER

Risk of contamination for the user due to inadequate cleaning or failure to observe the cleaning instructions.

- Observe cleaning instructions.
- Wear personal protective equipment when cleaning the device.
- Observe laboratory regulations (e.g. TRBAs, the German Protection against Infection Act, hygiene plan) for handling biological agents.

- The device and its accessories must not be cleaned in dishwashers.
- Only perform hand cleaning and liquid disinfection.
- The water temperature must not exceed 25 °C.
- To prevent any corrosion due to use of detergents or disinfectants, it is essential to follow the special application instructions provided by the manufacturers of the detergent or disinfectant.

Disinfectant:

- Surface disinfectant (not disinfectant for hands or instruments)
- Ethanol as the sole active substance.
Do not use an ethanol-propanol mixture to disinfect the viewing window in the lid of the device.
- Concentration not less than 30%
- pH: 6 – 8
- Non-corrosive

8.3 Cleaning

Cleaning the device

1. → Open the lid.
2. → Switch off the device and disconnect it from the power supply.
3. → Remove accessories.
4. → Clean the centrifuge housing and the centrifuging chamber with soap or a mild detergent and a damp cloth.
5. → Remove any detergent residues with a damp cloth after using detergents.
6. → The surfaces must be dried immediately after cleaning.
7. → Dry the centrifuging chamber with an absorbent cloth if condensation forms.

Cleaning biosafety systems

1. → Clean the biosafety system using the detergent and a damp cloth.
2. → Remove any detergent residues with a damp cloth after using detergents.

3. → Dry the accessories immediately after cleaning using a lint-free cloth and oil-free compressed air. Dry all cavities completely using oil-free compressed air.

Cleaning accessories

1. → Clean the accessories using the detergent and a damp cloth.
2. → Remove any detergent residues with a damp cloth after using detergents.
3. → Dry the accessories immediately after cleaning using a lint-free cloth and oil-free compressed air. Dry all cavities completely using oil-free compressed air.

8.4 Disinfection



Disinfection must always be preceded by cleaning the components concerned.

See → Chapter 8.3 'Cleaning' on page 31



Disinfectant concentration and application time according to the manufacturer's instructions.

Disinfecting the device



CAUTION

Risk of injury due to ingress of water or other liquids.

- Protect the device against external liquids.
- Do not disinfect the device using spray.

1. → Open the lid.
2. → Switch off the device and disconnect it from the power supply.
3. → Remove accessories.
4. → Clean the housing and centrifuging chamber using disinfectant.
5. → Remove any disinfectant residues with a damp cloth after using disinfectants.
6. → The surfaces must be dried immediately after cleaning.

Disinfecting the accessories

1. → Disinfect the accessories using the disinfectant.
2. → Wet all cavities with bubble-free disinfectant.
3. → Remove the disinfectant residues or leave them to dry after using disinfectants.

Autoclaving

The following accessories may be autoclaved at 121 °C / 250 °F (20 min):

- Swing-out rotors
- Aluminium angle rotors
- Metal buckets
- Lid with bioseal
- Inserting

No statement can be made about the resulting degree of sterility.

The lids of the rotors and bucket must be removed before autoclaving.

Autoclaving accelerates the ageing of materials. It may cause changes in colour. After autoclaving, the rotors and accessories are to be visually inspected for damage and any damaged parts are to be replaced immediately.

The sealing ring in question is to be replaced if there are signs of cracking, embrittlement or wear. For lids with non-replaceable sealing rings, the whole lid must be replaced.

The sealing rings must be replaced after autoclaving to ensure the tightness of the biosafety systems.

8.5 Maintenance

Greasing the rubber seal of the centrifuging chamber

- Rub the sealing ring lightly with a rubber care product.

Greasing the rubber seal of the biosafety system

- Rub the sealing ring lightly with a rubber care product.

Trunnion greasing

1. → Remove accessories.
2. → Clean the trunnions.
3. → Remove any detergent residues with a damp cloth after using detergents.
4. → Grease the trunnions and suspension with Hettich Tubenfett 4051.
5. → Excess grease in the centrifuging chamber must be removed.

Checking the accessories

1. → The accessories shall be checked for wear and corrosion damage.
2. → Check that the rotor is firmly seated.

Checking the biosafety system

1. → Visually check all parts of the biosafety system for damage.
2. → Check the correct installation position of the sealing ring(s) of the biosafety system.
3. → Replace the damaged parts of the biosafety system.
4. → Replace the sealing ring in question immediately if there are signs of cracking, embrittlement or wear. For lids with non-replaceable sealing rings, the whole lid must be replaced.

Centrifuging chamber damage inspection

- Check the centrifuging chamber for damage.

Greasing the motor shaft

1. → Remove accessories.
2. → Clean the motor shaft.
3. → Remove any detergent residues with a damp cloth after using detergents.
4. → Grease the motor shaft with Hettich Tubenfett 4051.
5. → Excess grease in the centrifuging chamber must be removed.

Accessories with a limited service life

The use of certain accessories is time-limited. For safety reasons, the accessories must no longer be used when either the maximum number of permissible run cycles marked on them or the expiry date marked on them has been reached.

- The maximum permissible number of run cycles or the expiry date can be seen on the accessories.

Replacing centrifuge tubes



CAUTION

Risk of injury from broken glass.

Broken glass may cause glass splinters and contaminated liquids to be found inside the centrifuge.

- Wear cut-resistant gloves.
- Wear protective goggles and a face mask.

Broken parts of the tube, glass splinters and spilled centrifuge material must be removed completely in the event of leakage or if a centrifuge tube breaks. Glass splinters that are not removed will cause further glass breakage.

The rubber inserts and the plastic sleeves of the rotors must be replaced after a glass breakage.

Disinfection must be carried out if the material is infectious.

9 Troubleshooting

9.1 Fault description

Customer service must be notified if the fault cannot be rectified based on the fault table. State the centrifuge type and serial number. Both numbers can be seen on the type plate of the centrifuge.

Fault description	Cause	Remedy
no display	No power. Mains input fuses defective.	<ul style="list-style-type: none"> ■ Check the supply voltage. ■ Check the mains input fuse. ■ Set the mains switch to <i>/I/</i>.
-1-	Tacho error. Speed pulse failure.	<ul style="list-style-type: none"> ■ The device must not be switched off while the <i>'Rotation'</i> indicator is lit up and rotating. <p>Wait until the <i>'Lid closed'</i> symbol is displayed (after approx. 100 seconds) and then perform a MAINS RESET.</p>
-2-	Loss of mains power during the centrifugation run. The centrifugation run was not completed.	<ul style="list-style-type: none"> ■ Open the lid and press the <i>[START]</i> button. ■ If required: Repeat the centrifugation run.
-3-	Imbalance. The rotor is unevenly loaded.	<ul style="list-style-type: none"> ■ Open the lid. ■ Check the loading of the rotor. ■ Repeat the centrifugation run.
-4-	Communication. Error in the control section or power section.	<ul style="list-style-type: none"> ■ Perform a MAINS RESET.
-5-	Overload. Motor or motor control defective.	<ul style="list-style-type: none"> ■ Perform a MAINS RESET.

Fault description	Cause	Remedy
-6-	Overvoltage. Mains voltage outside tolerances.	<ul style="list-style-type: none"> ■ Perform a MAINS RESET. ■ Check the mains voltage.
-7-	Overspeed. Error in the power section.	<ul style="list-style-type: none"> ■ Perform a MAINS RESET.
-8-	Undervoltage. Mains voltage outside tolerances.	<ul style="list-style-type: none"> ■ Perform a MAINS RESET. ■ Check the mains voltage.
-9-	Overtemperature. Overtemperature switch in the motor has tripped.	<ul style="list-style-type: none"> ■ Open the lid using the emergency release. ■ Let the motor cool down.
Version Error	Wrong machine version set. The control section skips to the Settings menu.	<ul style="list-style-type: none"> ■ Use the <i>[t]</i> buttons to set the number 7. ■ Press the <i>[STOP]</i> button to save the settings. ■ Perform a MAINS RESET.
no speed indicator. Machine version set in the time indicator.	Version Error. Wrong machine version set. The control section skips to the Settings menu.	<ul style="list-style-type: none"> ■ Use the <i>[t]</i> buttons to set the number 7. ■ Press the <i>[STOP]</i> button to save the settings. ■ Perform a MAINS RESET.
-c-	Controller watchdog. Error in the power section.	<ul style="list-style-type: none"> ■ Perform a MAINS RESET.
-d-	Lid lock error.	<ul style="list-style-type: none"> ■ Perform a MAINS RESET.
-E-	Short circuit in the control section / power section.	<ul style="list-style-type: none"> ■ Perform a MAINS RESET.
-F-	No rotor detection when starting. No rotor inserted or defective tacho.	<ul style="list-style-type: none"> ■ Perform a MAINS RESET.
rot...	A new rotor has been detected.	<ul style="list-style-type: none"> ■ Press the <i>[START]</i> button.
888888 All indicator segments light up.	-	<ul style="list-style-type: none"> ■ Notify customer service.

9.2 Performing a MAINS RESET

1. ➤ Set the mains switch to *[0]*.
2. ➤ Wait 10 seconds.
3. ➤ Set the mains switch to *///*.

9.3 Emergency release

The lid cannot be unlocked by the motor in the event of a power failure. Emergency unlocking by hand must be performed.



! WARNING

Risk of electric shock due to maintenance and servicing work on live device.

- Disconnect the device from the mains before carrying out repairs and maintenance.



WARNING

Danger of cutting and crushing due to moving rotor.

- Do not open the lid until the rotor has stopped.

Personnel:

- Trained user

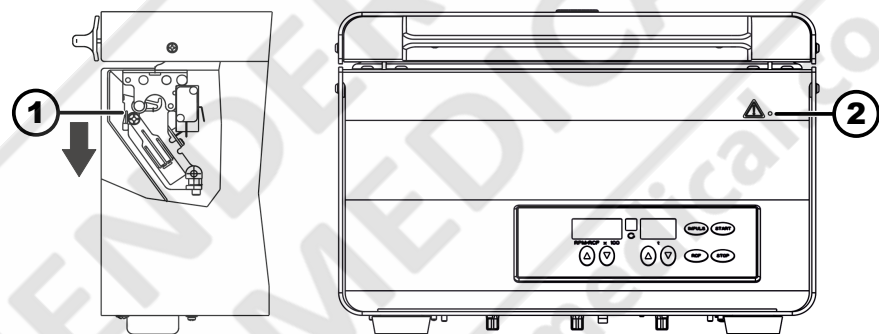

Fig. 20: Emergency release

- 1 Release pin
- 2 Hole

1. Look through the window in the lid to ensure that the rotor is stationary.
2. Insert the release pin (1) horizontally into the hole (2). Push it in until the handle strip can be swivelled upwards when the pin is pressed down.
3. Open the lid.

9.4 Replacing the mains input fuse



! WARNING

Risk of electric shock due to maintenance and servicing work on live device.

- Disconnect the device from the mains before carrying out repairs and maintenance.

Personnel:

- Trained user

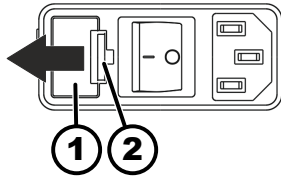

Fig. 21: Mains input fuse

- 1 Fuse holder
- 2 Snap lock

The mains fuses are located next to the mains switch.

The mains switch is in switch position [O]

1. ➤ Disconnect the mains cable from the device plug.
2. ➤ Press the snap lock (2) against the fuse holder (1) and pull it out.
3. ➤ Replace the defective mains input fuses.
Only use fuses with the nominal value specified for the type: see the table below.
4. ➤ Push in the fuse holder (1) until the snap lock engages.
5. ➤ Reconnect the device to the mains.

Model	Type	Fuse	Order no.
ROTOFIX 32 A	1206, 1206-34	T 3.15 AH/250 V	E997
ROTOFIX 32 A	1206-01, 1206-33	T 5 AH/250 V	E914

10 Disposal

10.1 General instructions



The device can be disposed of via the manufacturer.

A Return Material Authorisation (RMA) form must always be requested for a return.

If necessary, contact the Technical Service Department of the manufacturer:

- **Andreas Hettich GmbH & Co. KG**
- Föhrenstraße 12
- 78532 Tuttlingen, Germany
- Phone: +49 7461 705 1400
- E-Mail: service@hettichlab.com



! WARNING

Risk of pollution and contamination for people and the environment.

When disposing of the centrifuge, people and the environment may be polluted or contaminated by incorrect or improper disposal.

- Removal and disposal may be carried out only by a trained and authorized service personnel.

The device is intended for the commercial sector ("Business to Business" - B2B).

According to Directive 2012/19/EU, the devices may no longer be disposed of with household waste.

The appliances are assigned to the following groups according to the Stiftung Elektro-Altgeräte Register (EAR (German foundation under civil law)):

- Group 5 (small appliances)



The crossed-out wheeled bin symbol indicates that the device must not be disposed of with household waste. Regulations governing disposal of such devices may differ in individual countries. If necessary, contact the supplier.



Fig. 22: Household waste ban



11 Index

A

Accessories.	14
biosafety systems.	32
disinfection.	32
the rotor.	33
with limited service life.	33
Audible signal.	30
Autoclaving.	32

C

Care	
Intervals.	30
Centrifugation	
in continuous operation.	26
with higher substance density.	28
with time preselection.	27
Centrifuging chamber	
inspection.	33
Checking	
the biosafety system.	33
Cleaning.	31
biosafety systems.	31
Cleaning and disinfection	
Instructions.	31
Connecting the centrifuge.	19
Continuous operation.	26

D

Device	
biosafety systems.	31
disinfection.	32
Disinfection.	32
Disposal.	37

E

Error messages.	34
-------------------------	----

F

Fastening	
removal.	17
the transport lock.	16
Filling.	24
Foreseeable misuse.	6

G

General safety instructions.	7
Greasing	
the rubber seal.	33

I

Intended use.	5
-----------------------	---

L

Labels	
on the device.	12
on the packaging.	12

Lid

the lid.	20
Loading.	24

M

MAINS RESET.	35
Maintenance.	33
Intervals.	30

N

Non-intended use.	6
---------------------------	---

O

Operator's responsibility.	7
Original spare parts.	14

P

Personal protective equipment.	6
Personnel qualifications.	6
Personnel training.	7
Protective equipment.	6

R

Rating plate.	11
Relative centrifugal force	
RCF.	28
Removing	
the rotor.	20, 24, 25
Replacing	
centrifuge tubes.	34
Return.	15
Rotor detection.	29

S

Safety instructions.	7
Scope of delivery.	14
Setting up the centrifuge.	18
Short-term centrifugation.	27
Spare parts.	14
Storage conditions.	16
Switching off.	20
Switching the unit on.	20
Symbols.	5

T

Transport condition.	15
Troubleshooting.	34
Trunnion	
greasing.	33

U

Unpacking.	17
--------------------	----

Mode d'emploi

ROTOFIX 32 A



Traduction du mode d'emploi d'origine

©2023 - Tous droits réservés

Andreas Hettich GmbH & Co. KG

Föhrenstraße 12

D-78532 Tuttlingen/Allemagne

Téléphone : +49 (0)7461/705-0

Fax : +49 (0)7461/705-1125

Courriel : info@hettichlab.com, service@hettichlab.com

Internet : www.hettichlab.com



Table des matières

1	À propos de ce document.	5
1.1	Utilisation du présent document.	5
1.2	Remarque sur le genre.	5
1.3	Symboles et marques utilisés dans le présent document.	5
2	Sécurité.	5
2.1	Utilisation prévue.	5
2.2	Exigences relatives au personnel.	6
2.3	Responsabilité de l'exploitant.	7
2.4	Consignes de sécurité.	7
3	Aperçu de l'appareil.	9
3.1	Données techniques.	9
3.2	Enregistrement européen.	12
3.3	Étiquettes importantes sur l'emballage.	12
3.4	Étiquettes importantes sur l'appareil.	13
3.5	Éléments de commande et d'affichage.	13
3.5.1	Commande.	13
3.5.2	Éléments d'affichage.	14
3.5.3	Éléments de commande.	14
3.6	Pièces de rechange d'origine.	15
3.7	Contenu de la livraison.	15
3.8	Retour de marchandises.	15
4	Transport et stockage.	16
4.1	Conditions de transport et de stockage.	16
4.2	Fixer la sécurité de transport.	16
5	Mise en service.	17
5.1	Déballage de la centrifugeuse.	17
5.2	Retirer la sécurité de transport.	18
5.3	Mise en place et raccordement de la centrifugeuse.	18
5.4	Mettre en marche et arrêter la centrifugeuse.	20
6	Utilisation	20
6.1	Ouvrir et fermer le couvercle.	20
6.2	Démontage et remontage du rotor.	20
6.3	Insérer et retirer les nacelles.	22
6.4	Insérer et retirer les adaptateurs.	23
6.5	Charger.	24
6.6	Ouvrir et fermer le système de sécurité BIO.	26
6.6.1	Explication.	26
6.6.2	Couvercle avec fermeture à vis.	26
6.7	Centrifugation.	26
6.7.1	Centrifugation en continu.	26
6.7.2	Centrifugation avec présélection de la durée.	27
6.7.3	Centrifugation de courte durée.	27

7	Utilisation du logiciel.	28
7.1	Paramètres de centrifugation.	28
7.1.1	Régler le niveau de freinage.	28
7.1.2	Accélération centrifuge relative ACR.	28
7.1.3	Centrifugation de substances ou de mélanges de substances d'une densité supérieure à 1,2 kg/dm ³ .	29
7.1.4	Rayon de centrifugation.	29
7.2	Reconnaissance du rotor.	30
7.3	Menu de la machine.	30
7.3.1	Signal sonore.	30
7.3.1.1	Généralités.	30
7.3.1.2	Régler le signal acoustique.	30
8	Nettoyage et entretien.	30
8.1	Tableau récapitulatif.	30
8.2	Instructions de nettoyage et de désinfection.	31
8.3	Nettoyage.	32
8.4	Désinfection.	33
8.5	Maintenance.	34
9	Dépannage.	35
9.1	Description de l'anomalie.	35
9.2	Effectuer une RÉINITIALISATION DU RÉSEAU.	37
9.3	Déverrouillage d'urgence.	37
9.4	Remplacer le fusible d'entrée du réseau.	38
10	Mise au rebut.	38
10.1	Remarques générales.	38
11	Index.	40

1 À propos de ce document

1.1 Utilisation du présent document

- Avant la première mise en service de l'appareil, lire attentivement et intégralement ce document.
Le cas échéant, consulter les autres fiches d'information jointes.
- Ce document fait partie intégrante de l'appareil et doit être conservé à portée de main.
- Joindre ce document si l'appareil est transmis à un tiers.
- La version actuelle du document dans les langues disponibles est disponible sur le site Internet du fabricant : ➔ <https://www.hettichlab.com/de/download-center/>

1.2 Remarque sur le genre

La forme masculine ou féminine utilisée est destinée à faciliter la lecture. Par souci d'égalité de traitement, les termes utilisés s'appliquent en principe à tous les sexes et n'impliquent aucun jugement de valeur.

1.3 Symboles et marques utilisés dans le présent document

Symboles généraux

Les symboles suivants sont utilisés dans le présent document pour mettre en évidence les instructions d'action, les résultats, les énumérations, les références et d'autres éléments :

Identification	Explication
1. ➔ 2. ➔ 3. ➔ ... ➔	Instructions d'action étape par étape
➔	Résultats des étapes d'action
➔	Références aux sections du document et aux documents connexes
■ ... ■ ...	Listes sans ordre défini
[Bouton-poussoir]	Éléments de commande (par exemple : bouton-poussoir, interrupteur)
« Affichage »	Éléments d'affichage (par exemple : lampes de signalisation, éléments d'écran)

2 Sécurité

2.1 Utilisation prévue

Utilisation prévue

La centrifugeuse **ROTOFIX 32 A** est un dispositif médical de diagnostic in vitro conforme au règlement relatif aux dispositifs médicaux de diagnostic in vitro (UE) 2017/746. L'appareil sert à la centrifugation ainsi qu'à l'enrichissement d'échantillons d'origine humaine pour un traitement ultérieur à des fins de diagnostic. L'utilisateur peut régler les paramètres physiques modifiables concernés dans les limites définies par le dispositif.

La centrifugeuse peut être utilisée uniquement par un personnel qualifié dans des laboratoires fermés. La centrifugeuse est destinée uniquement à la fonction citée ci-dessus. L'utilisation conforme aux dispositions comprend le respect de toutes les indications énoncées dans les instructions d'utilisation et le respect des consignes d'inspection et de maintenance. Toute utilisation différente ou dépassant ce cadre est considérée comme non conforme. La société Andreas Hettich GmbH & Co. n'est pas responsable des dommages qui en résultent.

Utilisation non prévue

- La centrifugeuse n'est pas conçue pour être utilisée dans une atmosphère explosive, radioactive, biologiquement ou chimiquement contaminée.
- L'utilisateur doit prendre des mesures appropriées lors de la centrifugation de substances ou de mélanges de substances dangereuses qui sont toxiques, radioactives ou contaminées par des micro-organismes pathogènes.

Le fabricant recommande en principe de n'utiliser que des récipients de centrifugation avec des bouchons à vis spéciaux pour les substances dangereuses.

Pour les matières des groupes de risque 3 et 4, utiliser des récipients de centrifugation verrouillables avec système de sécurité biologique.

- Le fabricant ne recommande pas la centrifugation avec des matériaux inflammables ou explosifs.
- Le fabricant ne recommande pas la centrifugation avec des matériaux qui réagissent chimiquement entre eux avec une énergie élevée.

Mauvaise utilisation prévisible

Dans le cadre de l'utilisation prévue, le fabricant recommande de n'utiliser que des accessoires qu'il a approuvés.

N'utiliser la centrifugeuse que sous surveillance.

2.2 Exigences relatives au personnel

Qualifications requises

L'utilisateur a lu entièrement les instructions d'utilisation et s'est familiarisé avec l'appareil.



REMARQUE

Dommages causés à l'appareil par du personnel non autorisé

- Les interventions et modifications sur les appareils par des personnes non autorisées se font à leurs propres risques et entraînent la perte de tous les droits de garantie et de responsabilité.

Utilisateur formé

L'utilisateur est formé ou instruit au domaine du laboratoire et est en mesure d'exécuter les travaux qui lui sont confiés et de reconnaître et d'éviter lui-même les dangers éventuels.

Équipement de protection individuelle

L'absence ou l'inadéquation de l'équipement de protection individuelle augmente le risque d'atteinte à la santé et de blessures.

- N'utiliser que des équipements de protection individuelle en bon état.
- N'utiliser que des équipements de protection individuelle adaptés à la personne (par exemple en termes de taille).
- Respecter les indications relatives aux autres équipements de protection lors d'activités spécifiques.

2.3 Responsabilité de l'exploitant



Pour une utilisation correcte et sûre de l'appareil, suivre les instructions du présent document.

Conserver le mode d'emploi pour pouvoir le consulter ultérieurement.

Préparation des informations

- Le respect des instructions contenues dans ce document contribue à :
 - éviter les situations dangereuses ;
 - minimiser les coûts de réparation et les temps d'arrêt ;
 - augmenter la fiabilité et la durée de vie de l'appareil.
- L'exploitant est responsable du respect des prescriptions d'exploitation, des normes et des lois nationales.
- Noter et conserver la révision du document séparément du document. En cas de perte, le document peut être remplacé dans sa révision correcte.
- Garder le mode d'emploi disponible sur le lieu d'utilisation de l'appareil.
- Transmettre le mode d'emploi à l'acheteur en cas de vente de l'appareil.

Formation du personnel

Le manque de connaissances lors de travaux avec l'appareil peut entraîner des blessures graves ou la mort de personnes.

- Former le personnel à ses tâches et aux risques associés conformément aux instructions.

2.4 Consignes de sécurité



Notifications d'événements graves et d'incidents à signaler

En cas d'événements graves ou d'incidents à signaler concernant l'appareil ou ses accessoires, ceux-ci doivent être signalés au fabricant et, le cas échéant, à l'autorité compétente dans laquelle l'utilisateur et/ou le patient est établi.



DANGER

Risque de contamination de l'utilisateur en cas de nettoyage insuffisant ou de non-respect des consignes de nettoyage.

- Respecter les consignes de nettoyage.
- Porter un équipement de protection individuelle lors du nettoyage de l'appareil.
- Respecter les règles de laboratoire (par exemple TRBAs, IfSG, plan d'hygiène) pour la manipulation d'agents biologiques.

**DANGER**

Risque d'incendie et d'explosion dû à la présence de substances dangereuses dans les échantillons.

- Respecter les prescriptions et directives pertinentes pour la manipulation de produits chimiques et de substances dangereuses.
- Ne pas utiliser de produits chimiques agressifs (par exemple : agents d'extraction dangereux et corrosifs comme le chloroforme, acides forts).

**AVERTISSEMENT**

Dangers dus à une maintenance insuffisante ou non effectuée à temps.

- Respecter les intervalles de maintenance.
- Vérifier si l'appareil présente des dommages ou des défauts visibles.
En cas de dommages ou de défauts visibles, mettre l'appareil hors service et informer le technicien d'intervention.

 **AVERTISSEMENT**

Risque de choc électrique dû à la pénétration d'eau ou d'autres liquides.

- Protéger l'appareil contre les liquides provenant de l'extérieur.
- Ne pas verser de liquides à l'intérieur de l'appareil.
- Effectuer le transport avec l'emballage de transport d'origine.

 **AVERTISSEMENT**

Contamination par des substances ou des mélanges de substances dangereuses !

Respecter les mesures suivantes pour les substances et les mélanges de substances qui sont toxiques, radioactives et/ou contaminées par des micro-organismes pathogènes :

- En principe, n'utiliser que des récipients de centrifugation avec des bouchons à vis spéciaux pour les substances dangereuses.
- Pour les matières des groupes de risque 3 et 4, utiliser des récipients de centrifugation verrouillables avec système de sécurité biologique.
- Sans utilisation d'un système de sécurité biologique, l'appareil n'est pas microbiologiquement étanche au sens de la norme EN / CEI 61010-2-020.
- Contacter le fabricant si nécessaire.



AVERTISSEMENT

Risque de blessure et d'endommagement de l'appareil si le rotor est desserré.

- Lors du montage du rotor, l'entraîneur de l'arbre du rotor doit être correctement placé dans la rainure du rotor.
- Serrer à la main l'écrou de fixation du rotor.
- Vérifier que le rotor est bien fixé.
- Respecter les intervalles de maintenance.



ATTENTION

Risque de blessure par le rotor en rotation

Si le rotor est déplacé manuellement, les cheveux longs et les vêtements peuvent se prendre dans le rotor.

- Attacher les cheveux longs.
- Ne pas laisser pendre les vêtements dans la chambre d'essorage.



REMARQUE

Domages à l'électronique de l'appareil à cause d'une tension ou d'une fréquence incorrecte au niveau du disjoncteur de l'appareil.

- Utiliser l'appareil avec une tension et une fréquence de réseau correctes.

La valeur est indiquée dans les caractéristiques techniques et sur la plaque signalétique.



REMARQUE

Domages à l'appareil et des échantillons en raison d'une interruption prématurée du programme.

Une interruption prématurée du programme résulte d'une panne de courant, de la mise hors tension pendant le déroulement du programme ou du débranchement de la fiche d'alimentation.

- Ne pas éteindre l'appareil pendant le déroulement du programme.
- Ne pas déverrouiller l'appareil en urgence pendant le déroulement du programme.
- Ne pas débrancher la fiche secteur pendant le déroulement du programme.

3 Aperçu de l'appareil

3.1 Données techniques

Fabricant	Andreas Hettich GmbH & Co. KG, D-78532 Tuttlingen
Modèle	ROTOFIX 32 A

Type	1206 1206-34	1206-01 1206-33
Tension du réseau (±10%)	208-240 V 1~	100-127 V 1~
Fréquence du réseau	50-60 Hz	50-60 Hz
Puissance de raccordement	300 VA	300 VA
Courant absorbé	1,4 A	3,0 A
Capacité max.	4 x 100 ml / 32 x 15 ml	
Densité max. autorisée	1,2 kg/dm ³	
Régime de rotation max. (tr/min)	6000	
Accélération max. (ACR)	4226	
Énergie cinétique max.	3160 Nm	
Contrôle obligatoire (Règles DGUV 100-500) (valable uniquement en Allemagne)	Non	
Conditions d'environnement (EN / IEC 61010-1) :		
Lieu d'installation	uniquement à l'intérieur	
géog.	jusqu'à 2000 m au-dessus du niveau de la mer	
Température ambiante	2 °C à 40 °C	
Humidité de l'air	Humidité relative maximale 80 % pour des températures jusqu'à 31 °C, décroissant linéairement jusqu'à 50 % d'humidité relative pour 40 °C.	
Catégorie de surtension (CEI 60364-4-443)	II	
Degré de pollution	2	
Classe de protection de l'appareil	I Ne convient pas à une utilisation dans un environnement explosif.	
CEM :		
Émissions de parasites, Immunité aux interfé- rences	EN / IEC 61326-1 Classe B	Classe FCC B
Niveau sonore (en fonction du rotor)	≤57 dB(A)	

Dimensions :	
Largeur	366 mm
Profondeur	430 mm
géog.	257 mm
Poids	env. 23 kg

Plaque signalétique

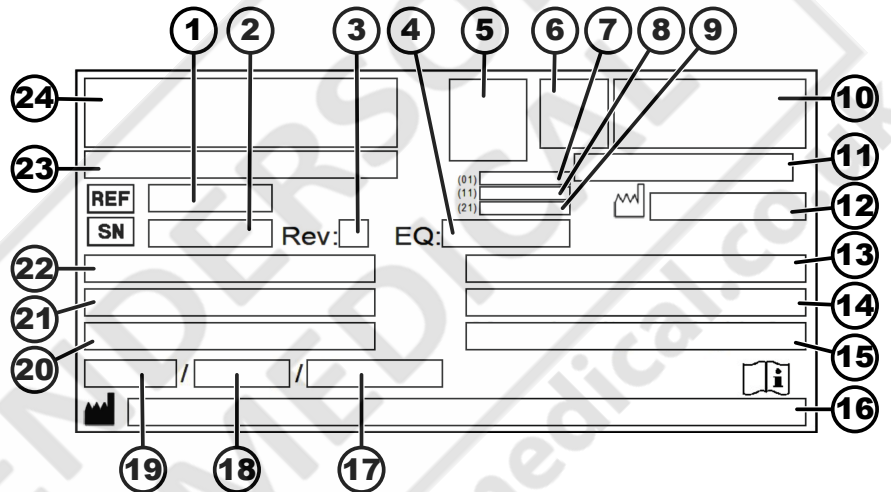

Fig. 1 : Plaque signalétique

- 1 Numéro d'article
- 2 Numéro de série
- 3 Révision
- 4 Numéro d'équipement
- 5 Code Datamatrix
- 6 évtl. Étiquetage si dispositif médical ou dispositif médical de diagnostic in vitro
- 7 Global Trade Item Number (GTIN)
- 8 Date de fabrication
- 9 Numéro de série
- 10 le cas échéant, sigle EAC, sigle CE
- 11 Pays de fabrication
- 12 Date de fabrication
- 13 Fréquence du réseau
- 14 Énergie cinétique maximale
- 15 Densité maximale autorisée
- 16 Adresse du fabricant
- 17 évtl. Pression du circuit de refroidissement
- 18 évtl. Quantité de liquide de refroidissement
- 19 évtl. Type de réfrigérant
- 20 Nombre de tours par minute
- 21 Valeurs de puissance
- 22 Tension du réseau
- 23 évtl. Désignation de l'appareil
- 24 Logo du fabricant

3.2 Enregistrement européen

Conformité de l'appareil

Conformité de l'appareil aux directives européennes.



Numéro d'enregistrement unique

SRN : DE-MF-000010680

UDI-DI de base

UDI-DI de base	Affectation des appareils
040506740100129P	ROTOFIX 32 A (agent de diagnostic in vitro)

3.3 Étiquettes importantes sur l'emballage

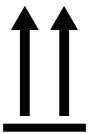
**HAUT**

Il s'agit de la position verticale correcte de l'emballage d'expédition pour le transport et/ou le stockage.

**MARCHANDISE FRAGILE**

Le contenu du paquet expédié est fragile, il doit donc être manipulé avec précaution.

**PROTÉGER DE L'HUMIDITÉ**

Le paquet expédié doit être tenu à l'écart de la pluie et maintenu dans un environnement sec.

**LIMITATION DE LA TEMPÉRATURE**

L'emballage d'expédition doit être stocké, transporté et manipulé dans la plage de température indiquée (-20 °C à +60 °C).

**LIMITATION DE L'HUMIDITÉ DE L'AIR**

Le paquet expédié doit être stocké, transporté et manipulé dans la plage d'humidité indiquée (10 % à 80 %).



LIMITATION D'EMPILEMENT EN FONCTION DU NOMBRE DE PIÈCES

Nombre maximal de colis identiques pouvant être empilés sur le colis le plus bas, où 'n' représente le nombre de colis autorisés. Le colis le plus bas n'est pas inclus dans 'n'.

3.4 Étiquettes importantes sur l'appareil



Les étiquettes de l'appareil ne doivent pas être enlevées ou recouvertes d'autres étiquettes.



Attention, zone de danger générale.

Avant d'utiliser l'appareil, il est impératif de lire les instructions de mise en service et d'utilisation et de respecter les consignes relatives à la sécurité !



Avertissement relatif à un risque biologique.



Sens de rotation du rotor.

L'alignement de la flèche indique le sens de rotation du rotor.



Symbole pour la collecte séparée des équipements électriques et électroniques, conformément à la directive 2012/19/UE (DEEE).

Utilisation dans les pays de l'Union européenne, en Norvège et en Suisse.

3.5 Éléments de commande et d'affichage

3.5.1 Commande

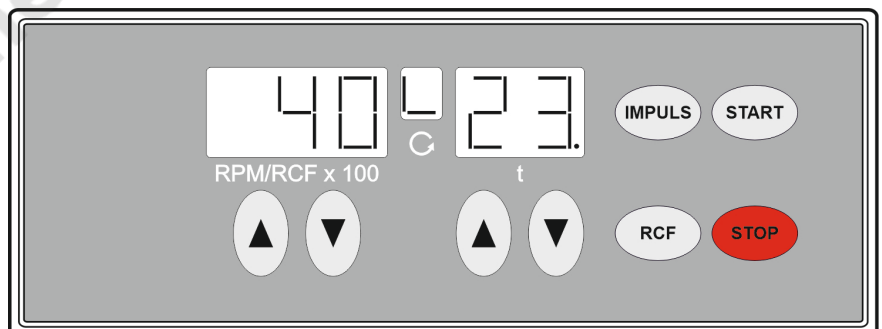

Fig. 2 : Commande

3.5.2 Éléments d'affichage

Fig. 3 : Affichage « Couvercle fermé »



Fig. 4 : Affichage « Couvercle ouvert »



Fig. 5 : Affichage « Rotation »

- L'affichage apparaît lorsque le couvercle est fermé.
- Si l'affichage « Couvercle fermé » et « Couvercle ouvert » clignote en alternance, la poursuite de l'utilisation de la centrifugeuse n'est possible qu'après avoir ouvert le couvercle une fois.
- L'affichage apparaît lorsque le couvercle est ouvert.
- L'affichage s'allume en rotation lorsque le rotor tourne.

3.5.3 Éléments de commande



Fig. 6 : [Interrupteur d'alimentation]



Fig. 7 : Touche [IMPULSE]



Fig. 8 : Touche [ACR]



Fig. 9 : Touche [START]



Fig. 10 : Touche [STOP]

RPM/RCFx100



Fig. 11 : Touche [RPM/ACRx100]

- Allumer et éteindre l'appareil.
- Centrifugation de courte durée. Le cycle de centrifugation a lieu tant que la touche est enfoncée.
- Afficher le niveau de freinage et le rayon de centrifugation.
- Accélération centrifuge relative, paramètre ACR. L'affichage de l'accélération centrifuge relative (ACR) a lieu tant que la touche est enfoncée.
- Démarrer le cycle de centrifugation.
- Terminer le cycle de centrifugation. Le rotor sort avec le niveau de freinage présélectionné.
- Enregistrer le niveau de freinage et le rayon de centrifugation.
- Il est possible de régler une valeur numérique de 500 tr/min jusqu'au régime maximal du rotor. Réglable par paliers de 100 (tr/min = valeur affichée x 100).
- Afficher le niveau de freinage et le rayon de centrifugation.

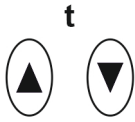

Fig. 12 : Touche [t]

- Saisir la durée de fonctionnement.
Réglable de 1 à 99 minutes par pas de 1 minute.
- Rayon de centrifugation.
Saisie en centimètres. Réglable de 5 à 16 centimètres, par pas de 1 centimètre.
- Niveaux de freinage 0 ou 1.
Niveau 1 = délai de ralentissement court
Niveau 0 = délai de ralentissement long

3.6 Pièces de rechange d'origine

N'utiliser que des pièces de rechange d'origine du fabricant et des accessoires autorisés.

3.7 Contenu de la livraison

Les accessoires suivants sont livrés avec la centrifugeuse :

- 1 goupille de déverrouillage
- 1 clé hexagonale à ergots (SW5 x 100)
- 1 graisse pour les tourillons de support
- 1 câble d'alimentation
- 2 cartouches fusibles
- 1 mode d'emploi
- 1 fiche d'information sur la sécurité du transport

Les rotors et les accessoires correspondants sont fournis en fonction de la commande.

3.8 Retour de marchandises

Pour un retour, il faut toujours demander un formulaire original de retour (RMA) du fabricant. Sans un formulaire de retour original du fabricant, il n'est pas possible de réceptionner et de comptabiliser la marchandise de manière sûre chez le fabricant. Le formulaire de retour (RMA) contient une déclaration de non-objection (DNO) qui doit être entièrement remplie et jointe au retour.

Si l'appareil et/ou les accessoires sont renvoyés au fabricant, le renvoi complet doit être nettoyé et décontaminé par l'expéditeur. Si les retours ne sont pas nettoyés ou insuffisamment nettoyés et/ou décontaminés, cette opération sera effectuée par le fabricant et facturée à l'expéditeur.

Pour le retour, les sécurités de transport d'origine doivent être fixées, voir ➔ *Chapitre 4 « Transport et stockage » à la page 16*. L'appareil doit être expédié dans son emballage d'origine.

4 Transport et stockage

4.1 Conditions de transport et de stockage

Conditions de transport



REMARQUE

Endommagement de l'appareil en cas de non-utilisation des sécurités de transport.

- Fixer les sécurités de transport avant de transporter l'appareil.



REMARQUE

Endommagement de l'appareil par la condensation.

En cas de différence de température entre le froid et le chaud, il y a un risque de formation de condensation sur les composants électrotechniques. Le condensat qui se forme peut provoquer un court-circuit ou détruire l'électronique.

- Réchauffer l'appareil pendant au moins 3 heures dans une pièce chaude avant de le brancher sur le secteur.
ou
- Faire chauffer pendant 30 minutes dans une pièce froide.

- Avant le transport, fixer la sécurité de transport et débrancher l'appareil de la prise de courant.
- La température de transport doit se situer entre -20 °C et +60 °C.
- L'humidité de l'air ne doit pas être condensée. L'humidité de l'air doit être comprise entre 10 % et 80 %.
- Tenir compte du poids de l'appareil.
- En cas de transport avec une aide au transport (par exemple un chariot de transport), l'aide au transport doit pouvoir supporter au moins 1,6 fois le poids de transport de l'appareil.
- Sécuriser l'appareil pendant le transport pour éviter qu'il ne se renverse ou ne tombe.
- Ne jamais transporter l'appareil sur le côté ou la tête en bas.

Conditions de stockage

- L'appareil doit être stocké dans son emballage d'origine.
- Ne stocker l'appareil que dans des locaux secs.
- La température de stockage doit être comprise entre -20 °C et +60 °C.
- L'humidité de l'air ne doit pas être condensée. L'humidité de l'air doit être comprise entre 10 % et 80 %.

4.2 Fixer la sécurité de transport

Personnel :

- Utilisateur formé

Le couvercle est fermé.

Le câble d'alimentation est déconnecté de l'appareil

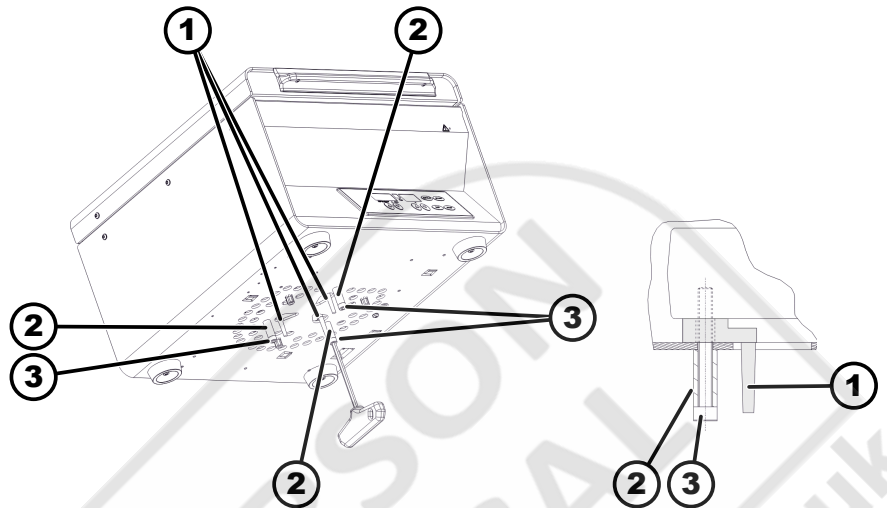

Fig. 13 : Sécurité de transport

- 1 Sécurité de transport
- 2 Manchons d'écartement
- 3 Vis

1. Basculer l'appareil sur la face arrière de l'appareil.
2. Mettre en place 3 sécurités de transport (1).
3. Visser 3 vis (3) avec les manchons d'écartement (2).

5 Mise en service

5.1 Déballage de la centrifugeuse



ATTENTION

Risque d'écrasement dû à des pièces qui tombent de l'emballage de transport.

- Maintenir l'appareil en équilibre pendant le déballage.
- N'ouvrir l'emballage qu'aux endroits prévus à cet effet.



ATTENTION

Risque de blessure en soulevant des charges lourdes.

- Prévoir un nombre adéquat d'assistants.
- Tenir compte du poids. Voir ➔ Chapitre 3.1 « Données techniques » à la page 9.



REMARQUE

Dommmages à l'appareil en cas de levage non conforme.

- Ne pas soulever la centrifugeuse par le panneau de commande ou par le support du panneau de commande.

Personnel :

- Utilisateur formé

1. Si disponible : Retirer les bandes d'emballage.
2. Soulever le carton vers le haut et retirer le rembourrage.
3. Retirer les accessoires et les conserver en lieu sûr.

4. ➤ Placer l'appareil sur une surface stable et plane.

5.2 Retirer la sécurité de transport

Personnel :

- Utilisateur formé

Le couvercle est fermé.

Le câble d'alimentation est déconnecté de l'appareil

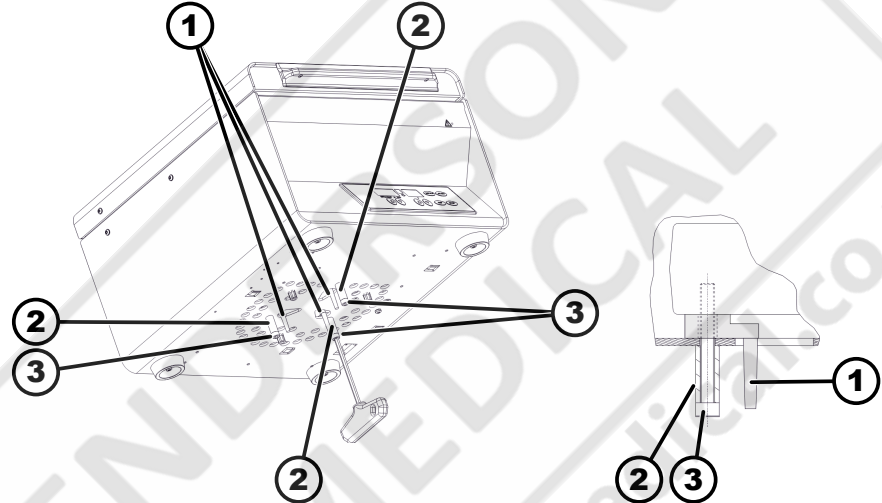

Fig. 14 : Sécurité de transport

- 1 Sécurité de transport
- 2 Manchons d'écartement
- 3 Vis

1. ➤ Basculer l'appareil sur la face arrière de l'appareil.
2. ➤ Dévisser 3 vis (3) avec les manchons d'écartement (2).
3. ➤ Retirer les 3 sécurités de transport (1) et les conserver en lieu sûr.
4. ➤ Conserver les vis, les entretoises et la sécurité de transport en lieu sûr.

5.3 Mise en place et raccordement de la centrifugeuse

Mise en place de la centrifugeuse



AVERTISSEMENT

Risque de blessure en raison d'une distance trop faible par rapport à la centrifugeuse.

- Pendant un cycle de centrifugation, conformément à EN / CEI 61010-2-020, aucune personne, aucune matière dangereuse et aucun objet ne doivent se trouver dans une **zone de sécurité de 300 mm** autour de la centrifugeuse.
- Une distance de **300 mm** doit être respectée par rapport aux fentes et aux ouvertures de ventilation de la centrifugeuse.



ATTENTION

Risque d'écrasement et d'endommagement de l'appareil en cas de chute due à des changements de position provoqués par des vibrations.

- Placer l'appareil sur une surface stable et plane
- Choisir la surface d'installation en fonction du poids de l'appareil.



REMARQUE

Endommagement des échantillons et de l'appareil en raison d'une température ambiante supérieure ou inférieure à la température maximale autorisée.

- Respecter la température ambiante maximale et minimale autorisée pour l'installation de l'appareil.
- Ne pas placer l'appareil à côté d'une source de chaleur.
- Ne pas exposer l'appareil aux rayons directs du soleil.
- Ne pas exposer l'appareil au gel.

Personnel :

- Utilisateur formé

1. Placer l'appareil sur une surface stable et plane.
2. Respecter une distance de 300 mm autour de l'appareil.
3. Respecter les conditions ambiantes indiquées dans les caractéristiques techniques (→ *Chapitre 3.1 « Données techniques » à la page 9*).

Raccordement de la centrifugeuse



REMARQUE

Dommages causés à l'appareil par du personnel non autorisé

- Les interventions et modifications sur les appareils par des personnes non autorisées se font à leurs propres risques et entraînent la perte de tous les droits de garantie et de responsabilité.



REMARQUE

Endommagement de l'appareil par la condensation.

En cas de différence de température entre le froid et le chaud, il y a un risque de formation de condensation sur les composants électrotechniques. Le condensat qui se forme peut provoquer un court-circuit ou détruire l'électronique.

- Réchauffer l'appareil pendant au moins 3 heures dans une pièce chaude avant de le brancher sur le secteur.
ou
- Faire chauffer pendant 30 minutes dans une pièce froide.

Personnel :

- Utilisateur formé

1. → Si l'appareil est protégé en plus par un disjoncteur différentiel dans l'installation du bâtiment, il faut utiliser un disjoncteur différentiel de type B.
En cas d'utilisation d'un autre type, il peut arriver que le disjoncteur différentiel ne coupe pas l'appareil en présence d'un défaut sur l'appareil ou qu'il coupe l'appareil alors qu'il n'y a pas de défaut sur l'appareil.
2. → Vérifier que la tension du réseau correspond à celle indiquée sur la plaque signalétique.
3. → Brancher l'appareil à une prise de courant normalisée à l'aide du câble d'alimentation.

5.4 Mettre en marche et arrêter la centrifugeuse

Mettre en marche la centrifugeuse

Personnel :

- Utilisateur formé
- Mettre l'interrupteur d'alimentation en position [I].
 - ➔ Selon le type de centrifugeuse, les touches clignotent.
 - Les dernières données de centrifugation utilisées s'affichent.

Éteindre la centrifugeuse

Le rotor s'arrête.

- Mettre l'interrupteur d'alimentation en position [O].

6 Utilisation

6.1 Ouvrir et fermer le couvercle

Ouvrir le couvercle

Personnel :

- Utilisateur formé
- La centrifugeuse est en marche.
- Le rotor s'arrête.

1. → Faire pivoter la poignée du couvercle vers le haut.
 - ➔ L'écran « *Couvercle ouvert* » s'affiche.
2. → Ouvrir le couvercle.

Fermer le couvercle



REMARQUE

Domages à l'appareil dû au claquement du couvercle.

- Fermer lentement le couvercle.
- Ne pas claquer le couvercle.

Personnel :

- Utilisateur formé
- Fermer le couvercle et faire pivoter la poignée vers le bas
 - ➔ L'écran « *Couvercle fermé* » s'affiche.

6.2 Démontage et remontage du rotor

Démonter le rotor avec l'écrou de serrage

Personnel :

- Utilisateur formé

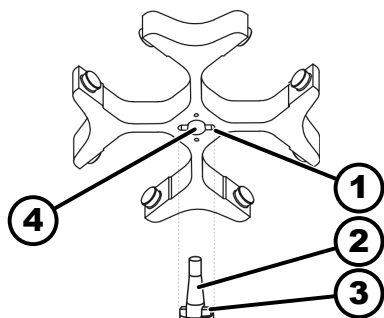

Fig. 15 : Montage et démontage du rotor

- 1 Gorge
- 2 Arbre du moteur
- 3 Toc d'entraînement
- 4 Alésage

Monter le rotor avec l'écrou de serrage

1. ➤ Ouvrir le couvercle.
2. ➤ Desserrer l'écrou de serrage du rotor à l'aide de la clé fournie.
 - Après avoir dépassé le point de pression de décollement, le rotor se détache du cône de l'arbre moteur (2).
3. ➤ Tourner l'écrou de serrage jusqu'à ce que le rotor puisse être soulevé de l'arbre du moteur.
4. ➤ Retirer le rotor.

Personnel :

- Utilisateur formé

Le couvercle est ouvert.

1. ➤ Nettoyer l'arbre du moteur (2) et l'alésage du rotor (4).
2. ➤ Graisser légèrement l'arbre du moteur (2), voir ➔ *Chapitre 8.2 « Instructions de nettoyage et de désinfection » à la page 31.*
3. ➤ Placer le rotor verticalement sur l'arbre du moteur (2).
Le toc d'entraînement (3) de l'arbre du moteur doit se trouver dans la gorge (1) du rotor. L'orientation de la gorge est indiquée sur le rotor.
4. ➤ Serrer à la main l'écrou de serrage du rotor à l'aide de la clé fournie.
5. ➤ Vérifier que le rotor est bien fixé.

Démonter le rotor sans l'écrou de serrage

Déposer le rotor

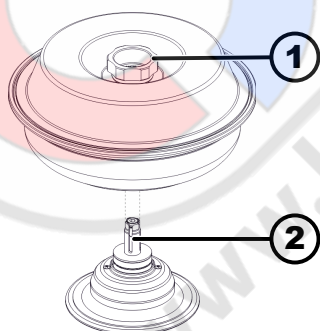

Fig. 16 : Montage et démontage du rotor

- 1 Poignée tournante
- 2 Moyeu

Personnel :

- Utilisateur formé

- Tenir le rotor par la poignée rotative (1) du couvercle et le soulever du moyeu (2).

Déposer le moyeu

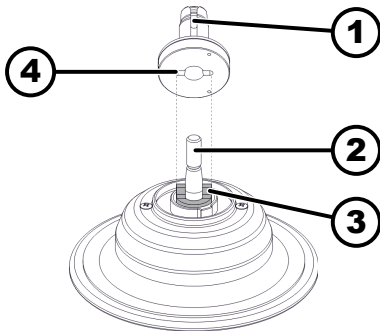

1. → Ouvrir le couvercle.
2. → Dévisser l'écrou de serrage.
 - ➔ Après avoir dépassé le point de pression de décollement, le moyeu (1) se détache du cône de l'arbre moteur (2).
3. → Retirer le moyeu.

Fig. 17 : Pose et dépose du moyeu

- 1 Moyeu
- 2 Arbre du moteur
- 3 Toc d'entraînement
- 4 Gorge

Reposer le rotor sans l'écrou de serrage

Monter le moyeu

Personnel :

- Utilisateur formé

1. → Ouvrir le couvercle.
2. → Nettoyer l'arbre du moteur (2) et l'alésage du rotor.
3. → Graisser légèrement l'arbre du moteur (2), voir ➔ *Chapitre 8.2 « Instructions de nettoyage et de désinfection » à la page 31.*
4. → Placer le moyeu (1) verticalement sur l'arbre du moteur (2).
Le toc d'entraînement (3) de l'arbre du moteur doit se trouver dans la gorge (4) du moyeu.

Vérifier que le moyeu est bien fixé.

5. → Serrer à la main l'écrou de serrage du moyeu à l'aide de la clé à ergots hexagonale fournie.
6. → Vérifier que le moyeu est bien fixé.

Poser le rotor

1. → Nettoyer le moyeu (2).
2. → Soulever le rotor par la poignée tournante et le placer verticalement sur le moyeu (2).
3. → Pousser le rotor vers le bas jusqu'à la butée

6.3 Insérer et retirer les nacelles

Insérer les nacelles



REMARQUE

Dommmages à l'appareil dus à des déséquilibres provoqués par une mauvaise charge du rotor.

- Charger toutes les places des rotors libres avec des nacelles identiques.



Les nacelles portant le numéro de l'emplacement du rotor ne doivent être utilisées qu'à cet endroit.

Les nacelles identifiées par un numéro de set ne peuvent être utilisées qu'ensemble.

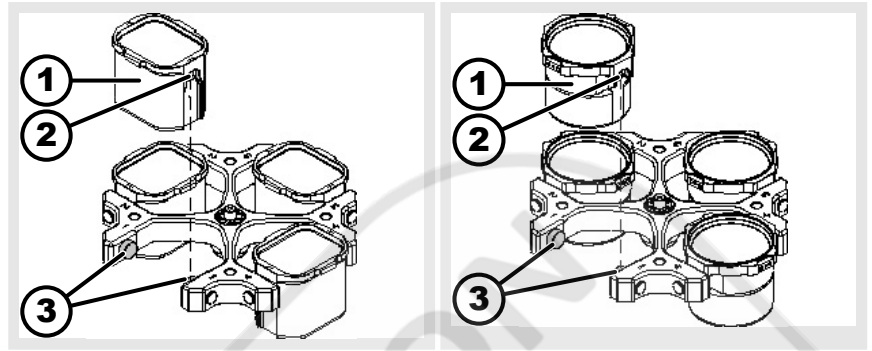

1. ➤ Vérifier que le rotor est bien fixé.
 2. ➤ Graisser les tourillons de support (3).
 3. ➤ Insérer la nacelle (1) dans le rotor par le haut. Les tourillons porteurs (3) doivent se trouver dans les rainures (2).
 4. ➤ Pousser la nacelle (1) vers le bas jusqu'à la butée.
- Tirer les nacelles (1) verticalement vers le haut pour les sortir du rotor.

Retirer les nacelles

6.4 Insérer et retirer les adaptateurs

Insérer

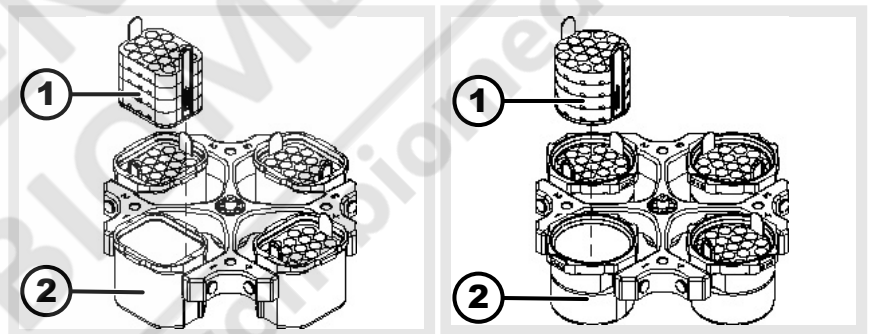

l'adaptateur

ôter

Adaptateur avec tourillon de positionnement

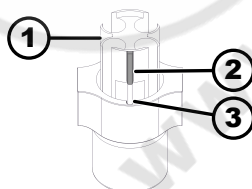

- Insérer l'adaptateur (1) verticalement par le haut dans les nacelles (2).
- Retirer l'adaptateur (1) de la nacelle (2) verticalement vers le haut.

Fig. 18 : Adaptateur avec tourillon de positionnement

- 1 Insérer
- 2 Tourillon de positionnement
- 3 Gorge

l'adaptateur

- Insérer l'adaptateur (1) dans la nacelle
- Le tourillon de positionnement (2) dans doit se trouver dans la gorge (3) de la nacelle.

ôter

 Retirer l'adaptateur (1) de la nacelle verticalement vers le haut.

6.5 Charger

Remplir les fioles de centrifugation



AVERTISSEMENT

Risque de blessure par des échantillons contaminés.

De l'échantillon contaminé s'échappe de la fiole d'échantillon pendant la centrifugation.

- N'utiliser que des récipients de centrifugation avec des bouchons à vis spéciaux pour les substances dangereuses.
- Pour les matériaux des groupes de risque 3 et 4, utiliser un système de biosécurité en plus des récipients de centrifugation verrouillables (voir le manuel 'Laboratory Biosafety Manual' de l'OMS).



REMARQUE

Dommmages à l'appareil dus à des substances fortement corrosives.

Les substances fortement corrosives peuvent nuire à la résistance mécanique des rotors, des nacelles et des accessoires.

- Ne pas centrifuger de substances fortement corrosives.



Les tubes de centrifugation standard en verre peuvent supporter des charges allant jusqu'à RZB 4000 (DIN 58970 partie 2).

Personnel :

- Utilisateur formé

→ Remplir les tubes de centrifugation à l'extérieur de la centrifugeuse.

La quantité maximale de remplissage des tubes de centrifugation indiquée par le fabricant ne doit pas être dépassée.

Pour les rotors angulaires, les tubes de centrifugation ne doivent être remplis que jusqu'à ce qu'aucun liquide ne puisse être éjecté des fioles pendant le cycle de centrifugation.

Afin de réduire au maximum les différences de poids à l'intérieur des tubes de centrifugation, veiller à un niveau de remplissage homogène dans les tubes.

Chargement des rotors libres

Personnel :

- Utilisateur formé

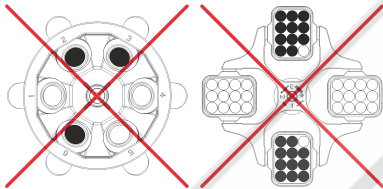
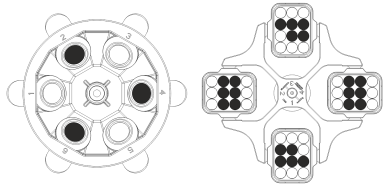
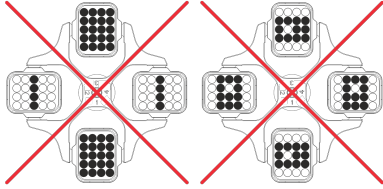
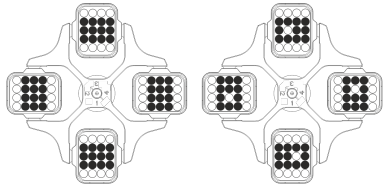

Chargement des rotors angulaires

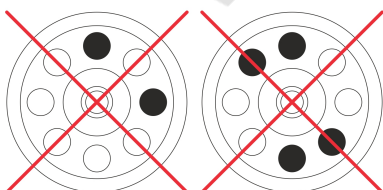
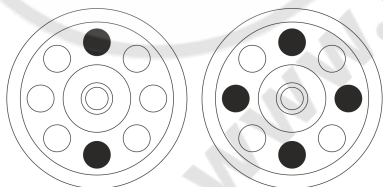
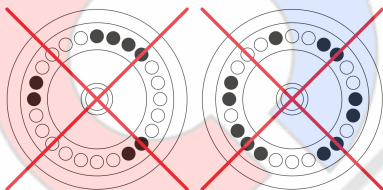
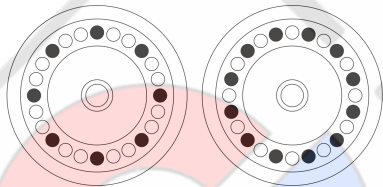

1. ➤ Vérifier que le rotor est bien fixé.
2. ➤ Les tubes de centrifugation doivent être répartis symétriquement et uniformément sur tous les emplacements du rotor.

La charge autorisée est indiquée sur chaque rotor. Ce poids ne doit pas être dépassé.

Lors du chargement des nacelles et de leur oscillation pendant le cycle de centrifugation, aucun liquide ne doit pénétrer dans les nacelles ni dans la chambre de centrifugation.

Dans le cas de tubes avec inserts en caoutchouc, le nombre d'inserts en caoutchouc sous les tubes de centrifugation doit toujours être identique.

Tous les emplacements du rotor doivent être occupés par des nacelles identiques. Certaines nacelles sont identifiées par le numéro de l'emplacement dans le rotor. Les nacelles sont à placer impérativement dans leur emplacement correspondant du rotor.

Les nacelles marquées d'un numéro de set (par exemple S001/4) ne peuvent être utilisées que dans le set.

Personnel :

- Utilisateur formé

1. ➤ Vérifier que le rotor est bien fixé.
2. ➤ Les tubes de centrifugation doivent être répartis uniformément sur tous les emplacements du rotor.

Lors du chargement du rotor, aucun liquide ne doit pénétrer dans le rotor et dans la chambre de centrifugation.

Pour les rotors, remplir les tubes de centrifugation uniquement jusqu'à un niveau où aucun liquide ne risque d'être éjecté des tubes pendant le cycle de centrifugation.

La charge autorisée est indiquée sur chaque rotor. Ce poids ne doit pas être dépassé.

6.6 Ouvrir et fermer le système de sécurité BIO

6.6.1 Explication

L'utilisateur doit prendre des mesures appropriées lors de la centrifugation de substances ou de mélanges de substances dangereuses qui sont toxiques, radioactives ou contaminées par des micro-organismes pathogènes.

Il faut toujours utiliser des récipients de centrifugation avec des bouchons à vis spéciaux pour les substances dangereuses.

Pour les matières des groupes de risque 3 et 4, il convient d'utiliser un système de biosécurité en plus des tubes de centrifugation verrouillables (voir le manuel « Laboratory Biosafety Manual » de l'Organisation mondiale de la santé).

Dans un système de sécurité biologique, un joint biologique (bague d'étanchéité) empêche les gouttelettes et les aérosols de s'échapper.

Si la nacelle d'un système de sécurité biologique est utilisée sans le couvercle, il faut en retirer l'anneau d'étanchéité pour éviter d'endommager l'anneau d'étanchéité pendant le cycle de centrifugation.

Les systèmes de biosécurité endommagés ne sont plus étanches d'un point de vue microbiologique.

Sans l'utilisation d'un système de sécurité biologique, une centrifugeuse n'est pas microbiologiquement étanche au sens de la norme EN / CEI 61010-2-020.

Stockage des systèmes de biosécurité

Pour éviter d'endommager les anneaux d'étanchéité pendant le stockage, les systèmes de sécurité biologiques doivent être stockés avec le couvercle ouvert.

6.6.2 Couvercle avec fermeture à vis

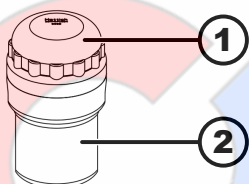

Fig. 19 : Système de BIOSécurité

- 1 Couvercle
- 2 Nacelle

Fermer

1. ➔ Placer le couvercle (1) au centre de la nacelle (2).
2. ➔ Tourner le couvercle (1) dans le sens des aiguilles d'une montre jusqu'à ce qu'il soit bien fermé.

Ouvrir

1. ➔ Tourner le couvercle (1) dans le sens inverse des aiguilles d'une montre jusqu'à ce qu'il soit ouvert.
2. ➔ Enlever le couvercle (1) de la nacelle (2).



6.7 Centrifugation

6.7.1 Centrifugation en continu

Personnel :





- Utilisateur formé

1. ➔ Régler le régime souhaité à l'aide des touches [RPM/ACR x 100].

2.  Remettre l'heure à zéro à l'aide des touches [t].
 - « "--" » s'affiche.
3.  Appuyer sur la touche [START].
 - Le cycle de centrifugation est lancé.
Le voyant « Rotation » est allumé en rotation tant que le rotor tourne.
Le comptage du temps commence à 0. La première minute est incrémentée en secondes, puis le temps est affiché en minutes. Si le temps est affiché en minutes, un point clignote à côté du chiffre.
Pendant le cycle de centrifugation, le régime de rotation du rotor ou la valeur ACR qui en résulte et le temps écoulé sont affichés.
4.  Appuyer sur la touche [STOP] pour interrompre le cycle de centrifugation.
La décélération s'effectue avec le niveau de freinage réglé. Le niveau de freinage est affiché.
Lorsque le rotor s'arrête, un signal sonore retentit.

6.7.2 Centrifugation avec présélection de la durée

Personnel :

- Utilisateur formé
1.  Régler le régime souhaité à l'aide des touches [RPM/ACR x 100].
 2.  Régler l'heure souhaitée à l'aide des touches [t].
 3.  Appuyer sur la touche [START].
 - Le cycle de centrifugation est lancé.
Le voyant « Rotation » est allumé en rotation tant que le rotor tourne.
Le temps est affiché en minutes. La dernière minute est décomptée en secondes. Si le temps est affiché en minutes, un point clignote à côté du chiffre.
Pendant le cycle de centrifugation, le régime du rotor ou la valeur ACR qui en résulte et le temps restant s'affichent.
 4.  Une fois le temps écoulé ou si le cycle de centrifugation est interrompu en appuyant sur la touche [STOP], la décélération s'effectue avec le niveau de freinage sélectionné.
Lorsque le rotor s'arrête, un signal sonore retentit.

6.7.3 Centrifugation de courte durée

Personnel :

- Utilisateur formé
1.  Régler le régime souhaité à l'aide des touches [RPM/ACR x 100].

2. ➤ Appuyer sur la touche *[IMPULSE]* et la maintenir enfoncée.
 - Le cycle de centrifugation est lancé.

Le voyant « *Rotation* » est allumé en rotation tant que le rotor tourne.

Le comptage du temps commence à 0. La première minute est incrémentée en secondes, puis le temps est affiché en minutes. Si le temps est affiché en minutes, un point clignote à côté du chiffre.

Pendant le cycle de centrifugation, le régime de rotation du rotor et le temps écoulé s'affichent.
3. ➤ Relâcher la touche *[IMPULSE]* pour terminer le cycle de centrifugation.
 - La décélération s'effectue avec le niveau de freinage réglé. Le niveau de freinage est affiché.

Lorsque le rotor s'arrête, un signal sonore retentit.

7 Utilisation du logiciel

7.1 Paramètres de centrifugation

7.1.1 Régler le niveau de freinage

1. ➤ Éteindre l'interrupteur d'alimentation.
2. ➤ Appuyer simultanément sur la touche ▲ *[RPM/ACR x 100]* et sur la touche *[IMPULSE]* et les maintenir enfoncées.
3. ➤ Mettre l'interrupteur d'alimentation en marche et relâcher les boutons.
 - Appuyer sur la touche ▲ *[RPM/ACR x 100]* jusqu'à ce que l'affichage du régime indique la version de la machine et l'affichage du temps indique le niveau de freinage réglé (ou « 0 » ou « 1 »).

La version de la machine est réglée en usine et ne peut pas être modifiée.

La version de la machine est réglée en usine et ne peut pas être modifiée.
4. ➤ Régler le niveau de freinage souhaité à l'aide des touches *[↑]*.
 - Niveau 1 = durée de décélération courte.
 - Niveau 0 = durée de décélération longue
5. ➤ Appuyer sur la touche *[STOP]* pour enregistrer les réglages.

7.1.2 Accélération centrifuge relative ACR

L'accélération centrifuge relative ACR dépend du régime et du rayon de centrifugation.

L'accélération centrifuge relative ACR est exprimée comme un multiple de l'accélération de la pesanteur terrestre (g).

L'accélération centrifuge relative ACR est une valeur numérique sans unité et sert à comparer les performances de séparation et de sédimentation.

$$RCF = \left(\frac{RPM}{1000} \right)^2 * r * 1,118$$

$$RPM = \sqrt{\frac{RCF}{r * 1,118}} * 1000$$

ACR = Accélération centrifuge relative

RPM = Régime en tr/min

r = rayon de centrifugation en mm = distance entre le centre de l'axe de rotation et le fond du tube de centrifugation.

Affichage de l'accélération centrifuge relative (ACR)

1. Pendant le cycle de centrifugation, appuyer sur la touche [ACR] et la maintenir enfoncée.
 - L'accélération centrifuge relative (ACR) s'affiche.
2. Relâcher la touche [ACR].
 - La vitesse de rotation s'affiche.

7.1.3 Centrifugation de substances ou de mélanges de substances d'une densité supérieure à 1,2 kg/dm³

Lors de la centrifugation à régime maximal, la densité des substances ou des mélanges de substances ne doit pas dépasser 1,2 kg/dm³. Pour les substances ou les mélanges de substances ayant une densité plus élevée, le régime doit être réduit. Le régime autorisé peut être calculé selon la formule suivante :

$$\text{Vitesse de centrifugation lente } (n_{red}) = \sqrt{\frac{1,2}{\text{densité supérieure [kg/dm}^3\text{]}}} * \text{Vitesse de rotation maximum [RPM]}$$

Par exemple : Régime maximal 4000 tr/min, densité 1,6 kg/dm³

$$n_{red} = \sqrt{\frac{1,2(\text{kg/dm}^3)}{1,6(\text{kg/dm}^3)}} * 4000 \text{ RPM} = 3464 \text{ RPM}$$

Si, dans un cas exceptionnel, la charge maximale indiquée sur la nacelle est dépassée, le régime doit également être réduit. Le régime autorisé peut être calculé selon la formule suivante :

$$\text{Vitesse de centrifugation lente } (n_{red}) = \sqrt{\frac{\text{Charge maximum (g)}}{\text{Charge réelle (g)}}} * \text{Vitesse de rotation maximum [RPM]}$$

Par exemple : Régime maximal 4000 tr/min, charge maximale 300 g, charge réelle 350 g

$$n_{red} = \sqrt{\frac{300 \text{ g}}{350 \text{ g}}} * 4000 \text{ RPM} = 3703 \text{ RPM}$$

En cas de doute, il convient de se renseigner auprès du fabricant.

7.1.4 Rayon de centrifugation

Le rayon de centrifugation doit être saisi en centimètres.

1. Éteindre l'interrupteur d'alimentation.
2. Appuyer simultanément sur la touche ▲ [RPM/ACR x 100] et sur la touche [IMPULSE] et les maintenir enfoncées.
3. Mettre l'interrupteur d'alimentation en marche et relâcher les boutons.
4. Appuyer sur la touche ▲ [RPM/ACR x 100] jusqu'à ce que le rayon de centrifugation et « rd » s'affichent.
5. Régler le rayon de centrifugation souhaité à l'aide des touches [t].
6. Appuyer sur la touche [STOP] pour enregistrer les réglages.

7.2 Reconnaissance du rotor

- Après le démarrage d'un cycle de centrifugation, une reconnaissance du rotor est effectuée.
- Si le rotor a été changé, le cycle de centrifugation est interrompu après la reconnaissance du rotor. Le code du rotor (rouge) s'affiche.
- Si le régime maximal du rotor utilisé est inférieur au régime réglé, le régime sera limité au régime maximal du rotor.

7.3 Menu de la machine

7.3.1 Signal sonore

7.3.1.1 Généralités

Le signal sonore retentit :

- après l'apparition d'une perturbation dans l'intervalle de 2 s.
- après la fin du cycle de centrifugation et l'arrêt du rotor dans l'intervalle de 30 s.

Le signal sonore s'arrête en ouvrant le couvercle ou en appuyant sur n'importe quelle touche.

7.3.1.2 Régler le signal acoustique

1. ➤ Éteindre l'interrupteur d'alimentation.
2. ➤ Appuyer simultanément sur la touche ▲ [RPM/ACR x 100] et sur la touche [IMPULSE] et les maintenir enfoncées.
3. ➤ Mettre l'interrupteur d'alimentation en marche et relâcher les boutons.
4. ➤ Appuyer sur la touche ▲ [RPM/ACR x 100] jusqu'à ce que « BEL 1 » ou « BEL 0 » s'affiche.
5. ➤ Régler « 0 » ou « 1 » à l'aide des touches [t] situées sous l'affichage de l'heure.
0 = signal sonore désactivé.
1 = signal sonore activé.
6. ➤ Appuyer sur la touche [STOP] pour enregistrer les réglages.

8 Nettoyage et entretien

8.1 Tableau récapitulatif

Chap.	Tâches à effectuer	en cas de besoin	tous les jours	toutes les semaines	tous les ans	page
8	Nettoyage et entretien					30
8.3	Nettoyage					32
8.3	Nettoyage de l'appareil		X			32

Chap.	Tâches à effectuer	en cas de besoin	tous les jours	toutes les semaines	tous les ans	page
8.3	Nettoyage des systèmes de biosécurité			X		32
8.3	Nettoyage des accessoires			X		32
8.4	Désinfection					33
8.4	Désinfection de l'appareil	X				33
8.4	Désinfection des accessoires	X				33
8.5	Maintenance					34
8.5	Graisser le joint en caoutchouc de la chambre d'essorage			X		34
8.5	Graisser le joint en caoutchouc du système de biosécurité			X		34
8.5	Graisser les tourillons de support			X		34
8.5	Vérification des accessoires			X		34
8.5	Vérifier le système de biosécurité			X		34
8.5	Vérifier que la chambre de centrifugation n'est pas endommagée				X	34
8.5	Graisser l'arbre moteur				X	34
8.5	Accessoires à durée d'utilisation limitée	X				35
8.5	Remplacer les fioles de centrifugation	X				35

8.2 Instructions de nettoyage et de désinfection



DANGER

Risque de contamination de l'utilisateur en cas de nettoyage insuffisant ou de non-respect des consignes de nettoyage.

- Respecter les consignes de nettoyage.
- Porter un équipement de protection individuelle lors du nettoyage de l'appareil.
- Respecter les règles de laboratoire (par exemple TRBAs, IfSG, plan d'hygiène) pour la manipulation d'agents biologiques.

- L'appareil et les accessoires ne doivent pas être nettoyés dans une machine à laver.
- Ne procéder qu'à un nettoyage à la main et à une désinfection liquide.

- La température de l'eau ne doit pas dépasser 25 °C.
- Pour éviter les phénomènes de corrosion dus aux produits de nettoyage ou de désinfection, il est impératif de respecter les consignes d'utilisation spécifiques du fabricant du produit de nettoyage ou de désinfection.

Désinfectant :

- Désinfectant pour surfaces (pas de désinfectant pour mains ou instruments)
- L'éthanol comme seule substance active.
Ne pas désinfecter le hublot du couvercle de l'appareil avec un mélange d'éthanol et de propanol.
- Concentration non inférieure à 30 %
- Valeur du pH : 6 - 8
- Non corrosif

8.3 Nettoyage

Nettoyage de l'appareil

1. Ouvrir le couvercle.
2. Éteindre l'appareil et le débrancher de l'alimentation électrique.
3. Retirer les accessoires.
4. Nettoyer le boîtier de la centrifugeuse et la chambre d'essorage avec du savon ou un détergent doux et un chiffon humide.
5. Après l'utilisation de produits de nettoyage, enlever les restes de produits de nettoyage avec un chiffon humide.
6. Les surfaces doivent être séchées immédiatement après le nettoyage.
7. En cas de formation de condensation, sécher la chambre d'essorage avec un chiffon absorbant.

Nettoyage des systèmes de biosécurité

1. Nettoyer le système de biosécurité avec le produit de nettoyage et un chiffon humide.
2. Après l'utilisation de produits de nettoyage, enlever les restes de produits de nettoyage avec un chiffon humide.
3. Sécher les accessoires immédiatement après le nettoyage avec un chiffon non pelucheux et de l'air comprimé exempt d'huile. Sécher complètement toutes les cavités avec de l'air comprimé exempt d'huile.

Nettoyage des accessoires

1. Nettoyer les accessoires avec le produit de nettoyage et un chiffon humide.
2. Après l'utilisation de produits de nettoyage, enlever les restes de produits de nettoyage avec un chiffon humide.
3. Sécher les accessoires immédiatement après le nettoyage avec un chiffon non pelucheux et de l'air comprimé exempt d'huile. Sécher complètement toutes les cavités avec de l'air comprimé exempt d'huile.

8.4 Désinfection



Une désinfection doit toujours être précédée d'un nettoyage des composants concernés.

Voir → Chapitre 8.3 « Nettoyage » à la page 32



Concentration et temps d'action du désinfectant selon les indications du fabricant.

Désinfection de l'appareil



ATTENTION

Risque de blessure dû à la pénétration d'eau ou d'autres liquides.

- Protéger l'appareil contre les liquides provenant de l'extérieur.
- Ne pas effectuer de désinfection par pulvérisation sur l'appareil.

1. Ouvrir le couvercle.
2. Éteindre l'appareil et le débrancher de l'alimentation électrique.
3. Retirer les accessoires.
4. Nettoyer le boîtier et la chambre d'essorage avec un désinfectant.
5. Après l'utilisation de désinfectants, enlever les résidus du désinfectant avec un chiffon humide.
6. Les surfaces doivent être séchées immédiatement après le nettoyage.

Désinfection des accessoires

1. Désinfecter les accessoires avec le désinfectant.
2. Humidifier toutes les cavités de désinfectant, sans bulles d'air.
3. Après l'utilisation de désinfectants, laisser sécher ou enlever les résidus du désinfectant.

Autoclave

Les accessoires suivants peuvent être autoclavés à 121 °C / 250 °F (20 min) :

- Rotors libres
- Rotors angulaires en aluminium
- Nacelles en métal
- Couvercle avec joint biologique
- Insertion

Il n'est pas possible de se prononcer sur le degré de stérilité.

Les couvercles des rotors et des nacelles doivent être retirés avant l'autoclavage.

Le passage à l'autoclavage accélère le processus de vieillissement des matériaux. Il peut provoquer des changements de couleur. Après l'autoclavage, les rotors et les accessoires doivent être contrôlés visuellement pour vérifier qu'ils ne sont pas endommagés et les pièces éventuellement endommagées doivent être remplacées immédiatement.

En cas de signes de fissuration, de fragilisation ou d'usure, le joint concerné doit être remplacé. Pour les couvercles dont les bagues d'étanchéité ne sont pas remplaçables, il faut remplacer l'ensemble du couvercle.

Pour garantir l'étanchéité des biosystèmes, les bagues d'étanchéité doivent être remplacées après l'autoclavage.

8.5 Maintenance

Graisser le joint en caoutchouc de la chambre d'essorage

- Frotter légèrement le joint d'étanchéité avec un produit d'entretien pour caoutchouc.

Graisser le joint en caoutchouc du système de biosécurité

- Frotter légèrement le joint d'étanchéité avec un produit d'entretien pour caoutchouc.

Graisser les tourillons de support

1. → Retirer les accessoires.
2. → Nettoyer les tourillons de support.
3. → Après l'utilisation de produits de nettoyage, enlever les restes de produits de nettoyage avec un chiffon humide.
4. → Graisser les tourillons de support et la nacelles libres avec de la graisse en tube Hettich 4051.
5. → L'excès de graisse dans la chambre d'essorage doit être éliminé.

Vérification des accessoires

1. → Les accessoires doivent être contrôlés pour vérifier l'absence d'usure et de dommages dus à la corrosion.
2. → Vérifier que le rotor est bien fixé.

Vérifier le système de biosécurité

1. → Vérifier visuellement que toutes les pièces du système de biosécurité ne sont pas endommagées.
2. → Vérifier la bonne position de montage de la ou des bagues d'étanchéité du système de biosécurité.
3. → Remplacer les pièces endommagées du système de biosécurité.
4. → En cas de signes de fissuration, de fragilisation ou d'usure, le joint concerné doit être immédiatement remplacé. Pour les couvercles dont les bagues d'étanchéité ne sont pas remplaçables, il faut remplacer l'ensemble du couvercle.

Vérifier que la chambre de centrifugation n'est pas endommagée

- Vérifier que la chambre de centrifugation n'est pas endommagée.

Graisser l'arbre moteur

1. → Retirer les accessoires.
2. → Nettoyer l'arbre du moteur.
3. → Après l'utilisation de produits de nettoyage, enlever les restes de produits de nettoyage avec un chiffon humide.
4. → Graisser l'arbre moteur avec de la graisse en tube Hettich 4051.
5. → L'excès de graisse dans la chambre d'essorage doit être éliminé.

Accessoires à durée d'utilisation limitée

L'utilisation de certains accessoires est limitée dans le temps. Pour des raisons de sécurité, les accessoires ne doivent plus être utilisés lorsque soit le nombre maximal de cycles de fonctionnement autorisé indiqué sur ceux-ci, soit la date d'expiration indiquée sur ceux-ci est atteinte.

- Le nombre maximal de cycles de fonctionnement autorisé ou la date d'expiration sont indiqués sur les accessoires.

Remplacer les fioles de centrifugation



ATTENTION

Risque de blessure par bris de verre.

En cas de bris de verre, des éclats de verre et des liquides contaminés peuvent se trouver à l'intérieur de la centrifugeuse.

- Porter des gants résistants aux coupures.
- Porter des lunettes de sécurité et un masque.

En cas de fuite ou de bris de fioles de centrifugation, les parties cassées des fioles, les éclats de verre et les matières centrifugées qui se sont écoulées doivent être entièrement éliminés. Les éclats de verre restants provoquent d'autres bris de verre.

Les inserts en caoutchouc et les manchons en plastique des rotors doivent être remplacés après un bris de verre.

S'il s'agit de matériel infectieux, une désinfection doit être effectuée.

9 Dépannage

9.1 Description de l'anomalie

Si le tableau des pannes ne permet pas de remédier à l'anomalie, il faut en informer le service après-vente. Indiquer le type de centrifugeuse et le numéro de série. Ces deux numéros sont indiqués sur la plaque signalétique de la centrifugeuse.

Description d'erreur	Origine	Remède
pas d'affichage	Pas de tension. Fusibles d'entrée du réseau défectueux.	<ul style="list-style-type: none"> ■ Vérifier la tension d'alimentation. ■ Vérifier les fusibles d'entrée du réseau. ■ Mettre l'interrupteur d'alimentation en position <i>III</i>.
-1-	Erreur de tachymètre. Défaillance des impulsions de régime.	<ul style="list-style-type: none"> ■ L'appareil ne doit pas être éteint tant que le voyant « <i>Rotation</i> » est allumé en rotation. <p>Attendre que le symbole « <i>Couvercle fermé</i> » s'affiche (après environ 100 secondes) et effectuer ensuite une RÉINITIALISATION DU RÉSEAU.</p>
-2-	Coupure du réseau pendant le cycle de centrifugation. Le cycle de centrifugation n'est pas terminé.	<ul style="list-style-type: none"> ■ Ouvrir le couvercle et appuyer sur la touche <i>[START]</i>. ■ En cas de besoin : Répéter le cycle de centrifugation.

Description d'erreur	Origine	Remède
-3-	Balourd. Le rotor est chargé de manière inégale.	<ul style="list-style-type: none"> ■ Ouvrir le couvercle. ■ Vérifier le chargement du rotor. ■ Répéter le cycle de centrifugation.
-4-	Communication. Erreur dans la partie commande ou dans la partie puissance.	<ul style="list-style-type: none"> ■ Effectuer une RÉINITIALISATION DU RÉSEAU.
-5-	Surcharge. Moteur ou commande de moteur défectueux.	<ul style="list-style-type: none"> ■ Effectuer une RÉINITIALISATION DU RÉSEAU.
-6-	Surtension. Tension du réseau en dehors des tolérances.	<ul style="list-style-type: none"> ■ Effectuer une RÉINITIALISATION DU RÉSEAU. ■ Vérifier la tension du réseau.
-7-	Surrégime. Erreur dans la partie puissance.	<ul style="list-style-type: none"> ■ Effectuer une RÉINITIALISATION DU RÉSEAU.
-8-	Sous-tension. Tension du réseau en dehors des tolérances.	<ul style="list-style-type: none"> ■ Effectuer une RÉINITIALISATION DU RÉSEAU. ■ Vérifier la tension du réseau.
-9-	Surchauffe L'interrupteur de surchauffe du moteur s'est déclenché.	<ul style="list-style-type: none"> ■ Ouvrir le couvercle par un déverrouillage d'urgence. ■ Laisser refroidir le moteur.
Version Error	Mauvaise version de machine réglée. La partie commande passe au menu de réglage.	<ul style="list-style-type: none"> ■ Définir le chiffre 7 à l'aide des touches <i>[t]</i>. ■ Appuyer sur la touche <i>[STOP]</i> pour enregistrer les réglages. ■ Effectuer une RÉINITIALISATION DU RÉSEAU.
Pas d'affichage du régime. Version de la machine réglée dans l'affichage de l'heure.	Version Error. Mauvaise version de machine réglée. La partie commande passe au menu de réglage.	<ul style="list-style-type: none"> ■ Définir le chiffre 7 à l'aide des touches <i>[t]</i>. ■ Appuyer sur la touche <i>[STOP]</i> pour enregistrer les réglages. ■ Effectuer une RÉINITIALISATION DU RÉSEAU.
-c-	Chien de garde du contrôleur. Erreur dans la partie puissance.	<ul style="list-style-type: none"> ■ Effectuer une RÉINITIALISATION DU RÉSEAU.
-d-	Erreur de verrouillage du couvercle.	<ul style="list-style-type: none"> ■ Effectuer une RÉINITIALISATION DU RÉSEAU.
-E-	Court-circuit dans la partie commande / puissance.	<ul style="list-style-type: none"> ■ Effectuer une RÉINITIALISATION DU RÉSEAU.
-F-	Pas de détection du rotor au démarrage. Pas de rotor inséré ou tachymètre défectueux.	<ul style="list-style-type: none"> ■ Effectuer une RÉINITIALISATION DU RÉSEAU.
rot...	Un nouveau rotor a été détecté.	<ul style="list-style-type: none"> ■ Appuyer sur la touche <i>[START]</i>.

Description d'erreur	Origine	Remède
888888 Tous les segments de l'affichage s'allument.	-	<ul style="list-style-type: none"> ■ Informer le service après-vente.

9.2 Effectuer une RÉINITIALISATION DU RÉSEAU

1. ➤ Mettre l'interrupteur d'alimentation en position [0].
2. ➤ Attendre 10 secondes.
3. ➤ Mettre l'interrupteur d'alimentation en position [//].

9.3 Déverrouillage d'urgence

En cas de panne de courant, le couvercle ne peut pas être déverrouillé par un moteur. Un déverrouillage manuel d'urgence doit être effectué.



⚠ AVERTISSEMENT

Risque d'électrocution lors de travaux de maintenance et d'entretien sur un appareil sous tension.

- Débrancher l'appareil avant d'effectuer des travaux de maintenance ou d'entretien.



⚠ AVERTISSEMENT

Risque de coupure et d'écrasement par le rotor en mouvement.

- N'ouvrir le couvercle que lorsque le rotor est à l'arrêt.

Personnel :

- Utilisateur formé

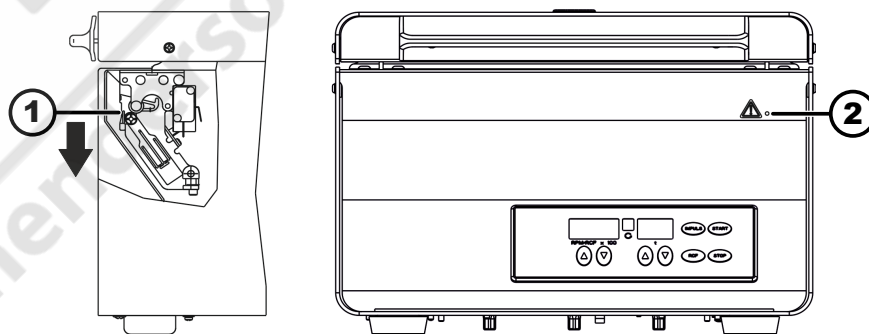

Fig. 20 : Déverrouillage d'urgence

- 1 Goupille de déverrouillage
- 2 Alésage

1. ➤ Regarder par la fenêtre du couvercle pour s'assurer que le rotor est à l'arrêt.
2. ➤ Introduire la goupille de déverrouillage (1) horizontalement dans l'alésage (2). Pousser jusqu'à ce que la poignée puisse pivoter vers le haut en poussant la goupille vers le bas.
3. ➤ Ouvrir le couvercle.

9.4 Remplacer le fusible d'entrée du réseau



⚠ AVERTISSEMENT

Risque d'électrocution lors de travaux de maintenance et d'entretien sur un appareil sous tension.

- Débrancher l'appareil avant d'effectuer des travaux de maintenance ou d'entretien.

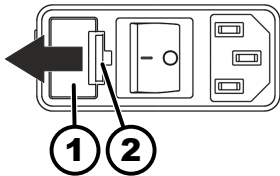

Fig. 21 : Fusible d'entrée du réseau

- 1 Porte-fusible
- 2 Fermeture à déclic

Personnel :

- Utilisateur formé

Les fusibles d'alimentation se trouvent à côté de l'interrupteur d'alimentation.

L'interrupteur d'alimentation est en position [0].

1. ➤ Débrancher le câble d'alimentation de la prise de l'appareil.
2. ➤ Appuyer les fermetures à déclic (2) contre le porte-fusible (1) et le retirer.
3. ➤ Remplacer les fusibles d'entrée du réseau défectueux.
N'utiliser que des fusibles ayant la valeur nominale définie pour le type, voir tableau ci-dessous.
4. ➤ Insérer le porte-fusible (1) jusqu'à ce que la fermeture à déclic s'enclenche.
5. ➤ Rebrancher l'appareil sur le secteur.

Modèle	Type	Fusible	N° de commande
ROTOFIX 32 A	1206, 1206-34	T 3,15 AH/250 V	E997
ROTOFIX 32 A	1206-01, 1206-33	T 5 AH/250 V	E914

10 Mise au rebut

10.1 Remarques générales



L'appareil peut être éliminé par le fabricant.

Pour un retour, il faut toujours demander un formulaire de retour (RMA).

Si nécessaire, contacter le service technique du fabricant.

- **Andreas Hettich GmbH & Co. KG**
- Föhrenstraße 12
- 78532 Tuttlingen, Allemagne
- Tél. : +49 7461 705 1400
- E-mail : service@hettichlab.com



! AVERTISSEMENT

Risque de pollution et de contamination pour les personnes et l'environnement

L'élimination incorrecte ou inappropriée de la centrifugeuse peut provoquer une pollution ou une contamination des personnes et de l'environnement.

- Le démontage et l'élimination ne doivent être effectués que par un spécialiste du service après-vente formé et agréé.

L'appareil est destiné à un usage professionnel (« Business to Business » - B2B).

Conformément à la directive 2012/19/UE, les appareils ne doivent plus être éliminés avec les déchets ménagers.

Les appareils sont classés dans les groupes suivants selon la fondation Elektro-Altgeräte Register (EAR) :

- Groupe 5 (petits appareils)

Le symbole de la poubelle barrée indique que l'appareil ne doit pas être éliminé avec les déchets ménagers. Les réglementations en matière d'élimination des déchets peuvent varier d'un pays à l'autre. En cas de besoin, adressez-vous au fournisseur.



Fig. 22 : Interdiction des déchets ménagers

11 Index

1, 2, 3 ...

(Dés)activer le. 30

A

Accélération centrifuge relative

ACR. 28

Accessoires. 15

à durée d'utilisation limitée. 35

l'appareil. 33

Autoclave. 33

C

Centrifugation

avec présélection de la durée. 27

avec une densité de tissu plus élevée. 29

en continu. 26

Centrifugation de courte durée. 27

Chargement. 24

du rotor. 24

Condition de transport. 16

Conditions de stockage. 16

Consignes de sécurité. 7

Consignes de sécurité générales. 7

Contenu de la livraison. 15

Couvercle

fermer. 20

ouvrir. 20

D

Déballage. 17

Démontage

du rotor. 20

Dépannage. 35

Désinfecter

l'appareil. 33

Désinfection. 33

E

Élimination. 38

Entretien. 34

Intervalles. 30

Équipement de protection. 6

Équipement de protection individuelle. 6

Éteindre. 20

Étiquettes

sur l'appareil. 13

sur l'emballage. 12

F

Fixer la sécurité

de transport. 16

radioactives. 18

Formation du personnel. 7

G

Graisser l'arbre

en caoutchouc. 34

Graisser le joint

en caoutchouc. 34

Graisser les tourillons

de support. 34

M

Marche continue. 26

Mauvaise utilisation prévisible. 6

Messages d'erreur. 35

Mise en marche. 20

Mise en place de la centrifugeuse. 18

Montage

du rotor. 20

N

Nettoyage. 32

Nettoyage et désinfection

Remarques. 31

Nettoyer

l'appareil. 32

Nettoyer les

accessoires. 32

Nettoyer les systèmes

de biosécurité. 32

NETZ-RESET. 37

P

Pièces de rechange. 15

Pièces de rechange d'origine. 15

Plaque signalétique. 11

Poser

du rotor. 25

Q

Qualification du personnel. 6

Qualifications du personnel. 6

R

Raccordement de la centrifugeuse. 19

Reconnaissance du rotor. 30

Remplacer les fioles

de centrifugation. 35

Remplir. 24

Responsabilité de l'exploitant. 7

Retour. 15

S

Symboles. 5

T

Trouble shooting. 35

U

Utilisation non prévue. 6

Utilisation prévue. 5

V

Vérifier la chambre

de centrifugation. 34

Vérifier les

accessoires. 34

Vérifier les systèmes
de biosécurité. 34





Istruzioni per l'uso

ROTOFIX 32 A



Traduzione delle istruzioni per l'uso originali

©2023 - Tutti i diritti riservati.

Andreas Hettich GmbH & Co. KG

Föhrenstraße 12

D-78532 Tuttlingen/Germania

Telefono: +49 (0)7461/705-0

Fax: +49 (0)7461/705-1125

E-mail: info@hettichlab.com, service@hettichlab.com

Internet: www.hettichlab.com



Indice

1	Informazioni su questo documento.	5
1.1	Campo applicativo del documento.	5
1.2	Nota sul genere.	5
1.3	Simboli e identificazioni utilizzati in questo documento.	5
2	Sicurezza.	5
2.1	Usò previsto.	5
2.2	Requisiti del personale.	6
2.3	Responsabilità dell'operatore.	7
2.4	Avvertenze di sicurezza.	7
3	Panoramica dell'apparecchio.	9
3.1	Dati tecnici.	9
3.2	Registrazione europea.	12
3.3	Etichette importanti sulla confezione.	12
3.4	Etichette importanti sull'apparecchio.	13
3.5	Elementi di comando e di visualizzazione.	13
3.5.1	Controllo.	13
3.5.2	Elementi di visualizzazione.	13
3.5.3	Elementi operativi.	14
3.6	Pezzi di ricambio originali.	15
3.7	Dotazione.	15
3.8	Reso.	15
4	Trasporto e stoccaggio.	15
4.1	Condizioni di trasporto e stoccaggio.	15
4.2	Fissaggio della protezione di trasporto.	16
5	Messa in funzione.	17
5.1	Disimballaggio della centrifuga.	17
5.2	Rimozione della sicurezza di trasporto.	18
5.3	Installazione e collegamento della centrifuga.	18
5.4	Accensione e spegnimento della centrifuga.	20
6	Funzionamento	20
6.1	Apertura e chiusura del coperchio.	20
6.2	Montaggio e smontaggio del rotore.	20
6.3	Inserimento e rimozione dei supporti.	22
6.4	Inserimento e rimozione dell'adattatore.	23
6.5	Caricamento.	24
6.6	Apertura e chiusura del sistema di biosicurezza.	26
6.6.1	Spiegazione.	26
6.6.2	Coperchio con tappo a vite.	26
6.7	Centrifugazione.	26
6.7.1	Centrifugazione in funzionamento continuo.	26
6.7.2	Centrifugazione con preselezione del tempo.	27
6.7.3	Centrifugazione breve.	27

7	Funzionamento del software	28
7.1	Parametri di centrifugazione.	28
7.1.1	Impostazione del livello di frenata.	28
7.1.2	Accelerazione relativa della centrifuga RCF.	28
7.1.3	Centrifugazione di sostanze o miscele di sostanze con una densità superiore a 1,2 kg/dm ³	29
7.1.4	Raggio di centrifugazione.	29
7.2	Rilevamento del rotore.	29
7.3	Machine Menu.	30
7.3.1	Segnale acustico.	30
7.3.1.1	Generalità.	30
7.3.1.2	Impostazione del segnale acustico.	30
8	Pulizia e cura	30
8.1	Tabella riassuntiva.	30
8.2	Istruzioni per la pulizia e la disinfezione.	31
8.3	Pulizia.	32
8.4	Disinfezione.	32
8.5	Manutenzione.	33
9	Risoluzione dei problemi	35
9.1	Descrizione dell'errore.	35
9.2	Eeguire un RESET DI ALIMENTAZIONE.	36
9.3	Sblocco di emergenza.	36
9.4	Sostituzione del fusibile di ingresso della rete.	37
10	Smaltimento	38
10.1	Note generali.	38
11	Indice analitico	39

1 Informazioni su questo documento

1.1 Campo applicativo del documento

- Leggere in modo accurato e per intero il presente documento prima di mettere in funzione l'apparecchio.
Eventualmente attenersi anche alle ulteriori schede informative allegate.
- Questo documento fa parte dell'apparecchio e deve essere conservato a portata di mano.
- In caso si ceda l'apparecchio a terzi, consegnare anche il presente documento.
- La versione aggiornata del documento nelle varie lingue disponibili è riportata sulla pagina Internet del costruttore: ➔ <https://www.hettichlab.com/de/download-center/>

1.2 Nota sul genere

La forma maschile o femminile della lingua utilizzata serve a facilitare la lettura. Nell'interesse della parità di trattamento, i termini corrispondenti si applicano a tutti i generi in egual misura e valore.

1.3 Simboli e identificazioni utilizzati in questo documento

Simboli generali

Le seguenti identificazioni sono utilizzate nel presente documento per evidenziare istruzioni per l'uso, risultati, elenchi, riferimenti e altri elementi:

Identificazione	Spiegazione
1. ➔ 2. ➔ 3. ➔ ... ➔	Istruzioni per l'uso passo-passo
➔	Risultati delle azioni
➔	Riferimenti alle sezioni del documento e ai documenti applicabili
■ ... ■ ...	Elenchi in ordine sparso
[Pulsante]	Elementi operativi (ad esempio: pulsanti, interruttori)
«Display»	Elementi di visualizzazione (ad esempio: spie di segnalazione, elementi dello schermo)

2 Sicurezza

2.1 Uso previsto

Uso previsto

La centrifuga **ROTOFIX 32 A** è un dispositivo medico-diagnostico in vitro conforme al regolamento sui dispositivi medici diagnostici in vitro (UE) 2017/746. Il dispositivo è utilizzato per la centrifugazione e l'arricchimento di materiale campione di origine umana per la successiva elaborazione a fini diagnostici. L'utilizzatore può di volta in volta regolare i parametri fisici modificabili entro i limiti stabiliti dal dispositivo.

La centrifuga può essere utilizzata solo da personale qualificato in laboratori al chiuso. La centrifuga è destinata solo all'uso citato. L'uso previsto comprende anche l'osservanza di tutte le istruzioni del manuale operativo e il rispetto delle operazioni di ispezione e manutenzione. Qualsiasi altra forma di utilizzo è da considerarsi non conforme. La ditta Andreas Hettich GmbH & Co. KG è responsabile per i danni eventualmente risultanti.

Uso non previsto

- La centrifuga non è adatta all'uso in atmosfere esplosive, radioattive, biologiche o chimicamente contaminate.
- Quando si centrifugano sostanze pericolose o miscele di sostanze tossiche, radioattive o contaminate da microrganismi patogeni, l'utilizzatore è tenuto ad adottare misure adeguate.
In linea di principio, il costruttore consiglia l'uso esclusivo di provette per centrifuga con tappi a vite speciali per sostanze pericolose.
Per i materiali dei gruppi di rischio 3 e 4, utilizzare provette per centrifuga richiudibili con tappi a vite con sistema di biosicurezza.
- Il costruttore sconsiglia di effettuare la centrifugazione di materiali infiammabili o esplosivi.
- Il costruttore sconsiglia la centrifugazione di materiali in grado di reagire tra loro a livello chimico sprigionando notevole energia.

Uso improprio prevedibile

Nell'ambito della destinazione d'uso, il costruttore consiglia di utilizzare esclusivamente gli accessori da lui approvati.
Utilizzare la centrifuga solo sotto supervisione.

2.2 Requisiti del personale

Qualifiche richieste

L'utente ha letto per intero le istruzioni per l'uso e ha familiarizzato con l'apparecchio.



AVVISO

Danneggiamento dell'apparecchio da parte di personale non autorizzato

- La manomissione e la modifica dell'apparecchio da parte di persone non autorizzate sono a rischio e pericolo dell'utilizzatore e comportano la perdita di tutti i diritti di garanzia e di responsabilità.

Utente formato

L'utente è istruito o formato sulle attività di laboratorio ed è in grado di eseguire i compiti a lui assegnati e di riconoscere ed evitare autonomamente i possibili pericoli.

Dispositivi di protezione individuale

La mancanza o l'inadeguatezza dei dispositivi di protezione individuale aumenta il rischio di danni alla salute e di lesioni.

- Utilizzare solo dispositivi di protezione personale in condizioni adeguate.
- Utilizzare solo dispositivi di protezione individuale adeguati alla persona (ad esempio, per quanto riguarda le dimensioni).
- Osservare le istruzioni per ulteriori dispositivi di protezione da usare in caso di attività specifiche.

2.3 Responsabilità dell'operatore



Per un uso corretto e sicuro dell'apparecchio, seguire le istruzioni contenute in questo documento.

Conservare le istruzioni per l'uso per future consultazioni.

Fornitura di informazioni

- L'osservanza delle istruzioni contenute nel presente documento aiuta:
 - a evitare situazioni di pericolo;
 - a ridurre al minimo i costi di riparazione e i tempi di inattività;
 - ad aumentare l'affidabilità e la durata dell'apparecchio.
- L'operatore è responsabile dell'osservanza delle norme e degli standard aziendali e delle leggi nazionali.
- Annotare e conservare la revisione del documento separatamente dal documento stesso. In caso di smarrimento, il documento può essere sostituito con la revisione corretta.
- Tenere a portata di mano le istruzioni per l'uso nel luogo di utilizzo dell'apparecchio.
- Consegnare le istruzioni per l'uso all'acquirente in caso di vendita dell'apparecchio.

Formazione del personale

La mancanza di conoscenze nell'utilizzo dell'apparecchio può causare gravi lesioni o morte.

- Istruire il personale sulle mansioni da svolgere e sui rischi associati in base alle istruzioni.

2.4 Avvertenze di sicurezza



Segnalazione degli incidenti gravi e degli eventi con obbligo di notifica

In caso di incidenti gravi o con obbligo di notifica con il dispositivo o i suoi accessori, questi devono essere segnalati al produttore e, se del caso, all'autorità competente in cui risiede l'utilizzatore e/o il paziente.



PERICOLO

Rischio di contaminazione per l'utilizzatore a causa di una pulizia insufficiente o della mancata osservanza delle istruzioni di pulizia.

- Osservare le istruzioni per la pulizia.
- Indossare i dispositivi di protezione individuale durante la pulizia dell'apparecchio.
- Osservare le norme di laboratorio (ad esempio TRBA, IfSG, piano di igiene) per la manipolazione di agenti biologici.

**PERICOLO**

Pericolo di incendio e di esplosione per la presenza di sostanze pericolose nei campioni.

- Osservare le normative e le linee guida pertinenti per la manipolazione di prodotti chimici e sostanze pericolose.
- Non utilizzare sostanze chimiche aggressive (ad esempio, agenti estrattivi pericolosi e corrosivi come il cloroformio, acidi forti).

**AVVERTIMENTO**

Pericoli dovuti a una manutenzione insufficiente o non tempestiva.

- Rispettare gli intervalli di manutenzione.
- Controllare che l'apparecchio non presenti danni o difetti visibili.
In caso di danni o difetti visibili, mettere l'apparecchio fuori servizio e informare il tecnico dell'assistenza.

 **AVVERTIMENTO**

Pericolo di scosse elettriche dovute all'ingresso di acqua o altri liquidi.

- Proteggere l'unità dai liquidi provenienti dall'esterno.
- Non versare liquidi all'interno dell'apparecchio.
- Trasportare l'apparecchio utilizzando l'imballaggio di trasporto originale.

 **AVVERTIMENTO**

Contaminazione con sostanze e miscele pericolose!

In caso di sostanze e miscele di sostanze tossiche, radioattive e/o contaminate da microrganismi patogeni, osservare le seguenti misure:

- In linea di principio, utilizzare solo provette per centrifuga con tappi a vite speciali per sostanze pericolose.
- Per i materiali dei gruppi di rischio 3 e 4, utilizzare provette per centrifuga richiudibili con tappi a vite con sistema di biosicurezza.
- Senza l'utilizzo di un sistema di biosicurezza, l'apparecchio non è a tenuta microbiologica ai sensi della norma EN / IEC 61010-2-020.
- Se necessario, contattare il produttore.



AVVERTIMENTO

Rischio di lesioni e danni all'apparecchio a causa del rotore allentato.

- Quando si monta il rotore, il trascinatore dell'albero del rotore deve essere inserito correttamente nella scanalatura del rotore.
- Serrare a mano il dado di fissaggio del rotore.
- Controllare la tenuta del rotore.
- Rispettare gli intervalli di manutenzione.



ATTENZIONE

Rischio di lesioni dovuto alla rotazione del rotore

Se il rotore viene spostato manualmente, i capelli lunghi e gli indumenti possono impigliarsi nel rotore.

- Legare i capelli lunghi.
- Non lasciare che gli indumenti rimangano appesi nella camera di centrifuga.



AVVISO

Danni all'elettronica dell'apparecchio a causa di una tensione o frequenza errata sull'interruttore dell'apparecchio.

- Usare l'apparecchio con la tensione e la frequenza di rete corrette.

Il valore è riportato nei dati tecnici e sulla targhetta di identificazione.



AVVISO

Danneggiamento dell'unità e dei campioni a causa di un'interruzione prematura del programma.

L'interruzione prematura del programma può essere causata da un'interruzione di corrente, da uno spegnimento durante l'esecuzione del programma o dallo scollegamento della spina di rete.

- Non spegnere l'apparecchio durante l'esecuzione del programma.
- Non eseguire lo sblocco di emergenza durante l'esecuzione del programma.
- Non staccare la spina durante l'esecuzione del programma.

3 Panoramica dell'apparecchio

3.1 Dati tecnici

Produttore	Andreas Hettich GmbH & Co. KG, D-78532 Tuttlingen
Modello	ROTOFIX 32 A

Tipo	1206 1206-34	1206-01 1206-33
Tensione di rete ($\pm 10\%$)	208-240 V 1~	100-127 V 1~
Frequenza di rete	50-60 Hz	50-60 Hz
Valore di allaccio	300 VA	300 VA
Consumo energetico	1,4 A	3,0 A
Capacità max.	4 x 100 ml / 32 x 15 m	
Densità max. ammissibile	1,2 kg/dm ³	
Velocità massima (RPM)	6000	
Accelerazione massima (RCF)	4226	
Energia cinetica max.	3160 Nm	
Obbligo di ispezione (regolamento DGUV 100-500) (vale solo per la Germania)	No	
Condizioni ambientali (EN / IEC 61010-1):		
Luogo di installazione	solo in ambienti interni	
geogr.	fino a 2000 m sul livello del mare	
Temperatura ambiente	Da 2 °C a 40 °C	
Umidità dell'aria	umidità relativa massima dell'aria 80 % per temperature fino a 31 °C, decrescente in modo lineare fino al 50 % di umidità relativa a 40 °C.	
Categoria di sovratensione (IEC 60364-4-443)	II	
Grado di inquinamento	2	
Classe di isolamento del dispositivo	I Non adatto all'uso in atmosfere potenzialmente esplosive.	
EMC:		
Emissione di interferenze, immunità alle interferenze	EN / IEC 61326-1 Classe B	FCC Class B
Livello di rumore (a seconda del rotore)	≤ 57 dB(A)	
Dimensioni:		

Larghezza	366 mm
Profondità	430 mm
geogr.	257 mm
Peso	ca. 23 kg

Targhetta di identificazione

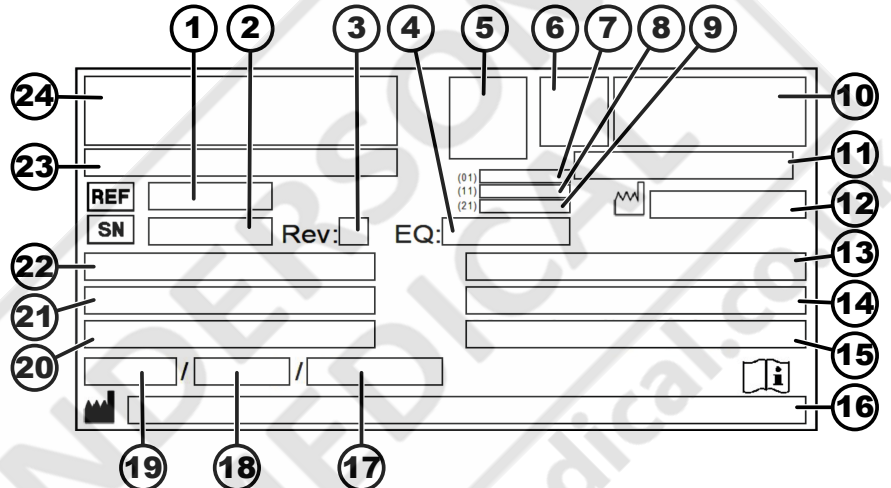

Fig. 1: Targhetta di identificazione

- 1 Numero articolo
- 2 Numero di serie
- 3 Revisione
- 4 Numero dell'apparecchiatura
- 5 Datamatrix Code
- 6 Se applicabile, identificazione se si tratta di un dispositivo medico o di un dispositivo diagnostico in vitro
- 7 Global Trade Item Number (GTIN)
- 8 Data di produzione
- 9 Numero di serie
- 10 Se applicabile, marchio EAC, marchio CE
- 11 Paese di produzione
- 12 Data di produzione
- 13 Frequenza di rete
- 14 Energia cinetica massima
- 15 Densità massima ammissibile
- 16 Indirizzo del produttore
- 17 Se applicabile, Pressione del circuito del refrigerante
- 18 Se applicabile, Quantità di riempimento del refrigerante
- 19 Se applicabile, Tipo di refrigerante
- 20 Giri al minuto
- 21 Valori delle prestazioni
- 22 Tensione di rete
- 23 Se applicabile, Designazione dell'apparecchio
- 24 Logo del produttore

3.2 Registrazione europea

Conformità dell'apparecchio

Conformità dell'apparecchio alle direttive UE.



Single Registration Number

SRN: DE-MF-000010680

Basic-UDI-DI

Basic-UDI-DI	Assegnazione dell'apparecchio
040506740100129P	ROTOFIX 32 A (Dispositivo diagnostico in vitro)

3.3 Etichette importanti sulla confezione

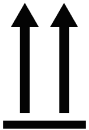

ALTO

Questa è la posizione verticale corretta dell'imballaggio della spedizione per il trasporto e/o lo stoccaggio.



FRAGILE

Il contenuto dell'imballaggio della spedizione è fragile, per cui deve essere maneggiato con cura.



PROTEGGERE DALL'UMIDITÀ

L'imballaggio della spedizione deve essere tenuto al riparo dalla pioggia e conservato in un ambiente asciutto.

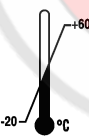

TEMPERATURA LIMITE

La confezione di trasporto deve essere conservata, trasportata e maneggiata entro l'intervallo di temperatura indicato (da -20 °C a +60 °C).



UMIDITÀ LIMITE

L'imballaggio della spedizione deve essere conservato, trasportato e maneggiato entro l'intervallo di umidità indicato (dal 10 % all' 80 %).



LIMITE PILA DI CONFEZIONI IN BASE AL NUMERO DI PEZZI

Numero massimo di confezioni identiche che possono essere impilate sulla confezione più bassa, dove "n" indica il numero di confezioni consentito. Il pacchetto più basso non è incluso in "n".

3.4 Etichette importanti sull'apparecchio



Le etichette sull'apparecchio non devono essere rimosse, coperte da altre o nascoste.



Attenzione, area di pericolo generica.

Prima di utilizzare l'apparecchio, leggere attentamente le istruzioni per la messa in funzione e il funzionamento e osservare le norme di sicurezza!



avviso di rischio biologico.



Rotazione del rotore.

La direzione della freccia indica la direzione di rotazione del rotore.



Simbolo per la raccolta differenziata delle apparecchiature elettriche ed elettroniche, in conformità alla direttiva 2012/19/UE (RAEE).

Utilizzo nei Paesi dell'Unione europea, in Norvegia e in Svizzera.

3.5 Elementi di comando e di visualizzazione

3.5.1 Controllo

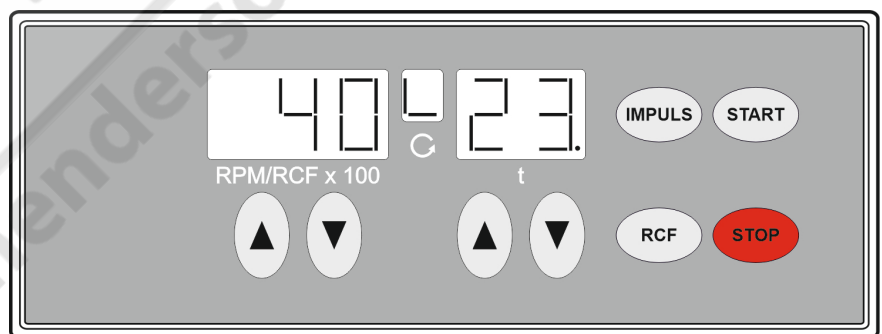

Fig. 2: Controllo

3.5.2 Elementi di visualizzazione

Fig. 3: Indicazione «Coperchio chiuso»

- L'indicazione appare quando il coperchio è chiuso.
- Se le indicazioni «Coperchio chiuso» e «Coperchio aperto» lampeggiano alternativamente, il funzionamento della centrifuga è possibile solo dopo aver aperto il coperchio una volta.



Fig. 4: Indicazione «Coperchio aperto»

- L'indicazione appare quando il coperchio è aperto.



Fig. 5: Indicazione «Rotazione»

- L'indicazione si accende quando il rotore ruota.

3.5.3 Elementi operativi



Fig. 6: [Interruttore di rete]

- Accendere e spegnere l'apparecchio.



Fig. 7: Pulsante [IMPULSE]

- Centrifugazione breve. L'esecuzione della centrifugazione avviene finché il tasto è premuto.
- Mostrare il livello di frenata e il raggio di centrifugazione.



Fig. 8: Pulsante [RCF]

- Accelerazione relativa della centrifuga, parametro RCF. L'accelerazione centrifuga relativa (RCF) viene mostrata finché il tasto è premuto.



Fig. 9: Pulsante [START]

- Avviare il ciclo di centrifugazione.



Fig. 10: Pulsante [STOP]

- Interrompere il ciclo di centrifugazione. Il rotore si interrompe al livello di frenata preselezionato.
- Salvare il livello di frenata e il raggio di centrifugazione.

RPM/RCFx100



Fig. 11: Pulsante [RPM/RCFx100]

- È possibile impostare un valore numerico da 500 RPM alla velocità massima del rotore. Regolabile in incrementi da 100 (RPM = valore indicato x 100).
- Mostrare il livello di frenata e il raggio di centrifugazione.

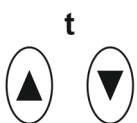

Fig. 12: Pulsante [t]

- Immettere il tempo di esecuzione. Regolabile da 1 a 99 minuti in incrementi di 1 minuto.
- Raggio di centrifugazione. Immissione in centimetri. Regolabile da 5 a 16 centimetri, in incrementi da 1 centimetro.
- Livelli di frenata 0 o 1. Livello 1 = tempo di decelerazione breve Livello 0 = tempo di decelerazione lungo.

3.6 Pezzi di ricambio originali

Utilizzare esclusivamente i ricambi originali del costruttore e gli accessori autorizzati.

3.7 Dotazione

Con la centrifuga vengono forniti i seguenti accessori:

- 1 perno di sblocco
- 1 chiave a perno esagonale (apertura 5 x 100)
- 1 grasso per i perni di supporto

- 1 cavo di rete
- 2 collegamenti del fusibile
- 1 copia delle istruzioni per l'uso
- 1 foglio informativo protezione di trasporto

I rotori e gli accessori corrispondenti sono forniti in base all'ordine.

3.8 Reso

Per il reso, richiedere sempre un apposito modulo di reso (RMA) originale del produttore. Senza un modulo di reso originale del produttore, non è possibile accettare e prenotare la merce in modo sicuro con il produttore. Il modulo di reso (RMA) contiene una dichiarazione di assenza di obiezioni (UBE), che deve essere compilata in ogni sua parte e allegata alla spedizione di reso.

Se l'apparecchio e/o gli accessori vengono restituiti al produttore, la spedizione di reso completa deve essere pulita e decontaminata dal mittente. Se i resi non vengono puliti e/o non sono sufficientemente decontaminati, il produttore provvederà a effettuare tale operazione e ad addebitare il costo al mittente.

Per la spedizione di reso, è necessario allegare le protezioni di trasporto originali, vedere ➔ *Capitolo 4 «Trasporto e stoccaggio» a pag. 15*. L'apparecchio deve essere spedito nell'imballaggio originale.

4 Trasporto e stoccaggio

4.1 Condizioni di trasporto e stoccaggio

Condizioni di trasporto



AVVISO

Danni all'apparecchio dovuti al mancato utilizzo delle protezioni di trasporto.

- Fissare le protezioni di trasporto prima di trasportare l'apparecchio.

**AVVISO****Danni all'apparecchio dovuti alla condensa.**

In presenza di una differenza di temperatura tra freddo e caldo, sussiste il rischio di formazione di condensa sui componenti elettrotecnici. La condensa che si forma può causare un cortocircuito o distruggere i componenti elettronici.

- Riscaldare l'apparecchio per almeno 3 ore in una stanza calda prima di collegarlo alla rete elettrica.
oppure
- riscaldarlo per 30 minuti in una stanza fredda.

- Prima del trasporto, fissare la protezione di trasporto e scollegare l'apparecchio dalla presa di corrente.
- La temperatura di trasporto deve essere compresa tra -20 °C e +60 °C.
- L'umidità non deve condensare. L'umidità deve essere compresa tra il 10 % e l'80 %.
- Osservare il peso dell'apparecchio.
- In caso di trasporto con un ausilio di trasporto (ad esempio, un carrello di trasporto), l'ausilio di trasporto deve essere in grado di trasportare almeno 1,6 volte il peso di trasporto dell'apparecchio.
- Assicurare l'apparecchio contro il ribaltamento e la caduta durante il trasporto.
- Non trasportare mai l'apparecchio di traverso o capovolto.

Condizioni di stoccaggio

- L'apparecchio deve essere conservato nella confezione originale.
- Conservare l'apparecchio solo in luoghi asciutti.
- La temperatura di stoccaggio deve essere compresa tra -20 °C e +60 °C.
- L'umidità non deve condensare. L'umidità deve essere compresa tra il 10 % e l'80 %.

4.2 Fissaggio della protezione di trasporto**Personale:**

- Utente formato

Il coperchio è chiuso.

Il cavo di rete è staccato dall'apparecchio.

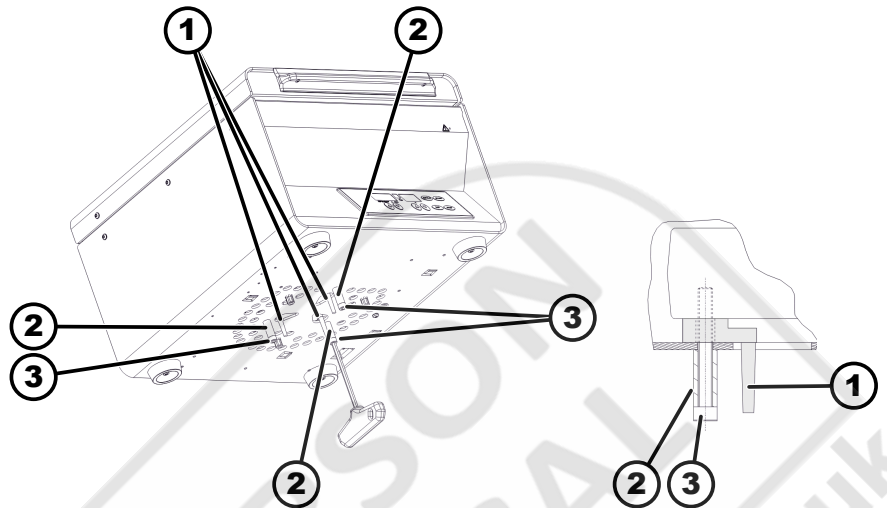

Fig. 13: Protezione di trasporto

- 1 Protezione di trasporto
- 2 Manicotti distanziatori
- 3 Viti

1. > Inclinare l'unità sul retro.
2. > Inserire 3 protezioni di trasporto (1).
3. > Avvitare 3 viti (3) con manicotti distanziatori (2).

5 Messa in funzione

5.1 Disimballaggio della centrifuga



ATTENZIONE

Rischio di schiacciamento dovuto alla caduta di parti dall'imballaggio di trasporto.

- Mantenere l'apparecchio in equilibrio durante il processo di disimballaggio.
- Aprire l'imballaggio solo negli appositi punti.



ATTENZIONE

Pericolo di lesioni a causa del sollevamento di carichi pesanti.

- Provvedere a un numero adeguato di aiutanti.
- Osservare il peso. Vedere ➔ *Capitolo 3.1 «Dati tecnici» a pag. 9.*



AVISO

Danni all'apparecchio dovuti a un sollevamento improprio.

- Non sollevare la centrifuga dal pannello di controllo o dal supporto del pannello di controllo.

Personale:

- Utente formato

1. > Se presenti: rimuovere le cinghie di imballaggio.
2. > Sollevare la confezione verso l'alto e rimuovere l'imbottitura.

3. ➤ Rimuovere gli accessori e riporli in modo sicuro.
4. ➤ Posizionare l'apparecchio su una superficie stabile e piana.

5.2 Rimozione della sicurezza di trasporto

Personale:

- Utente formato

Il coperchio è chiuso.

Il cavo di rete è staccato dall'apparecchio.

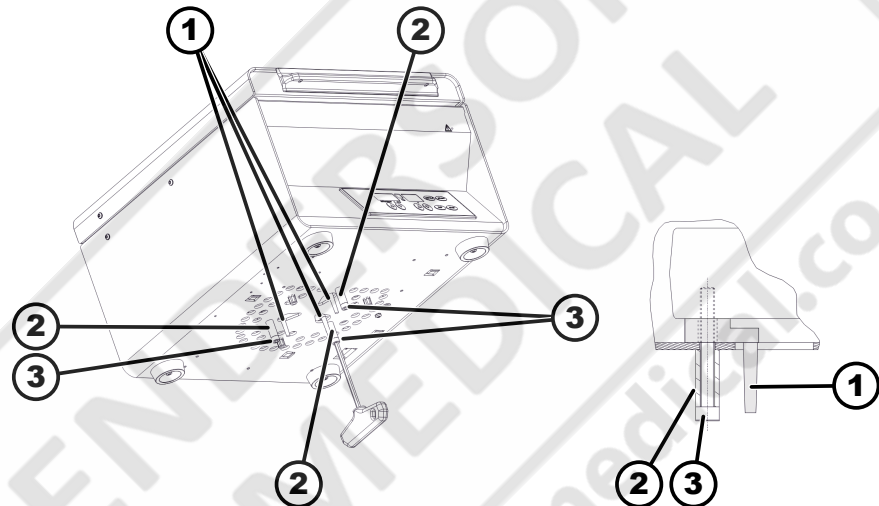

Fig. 14: Protezione di trasporto

- 1 Protezione di trasporto
- 2 Manicotti distanziatori
- 3 Viti

1. ➤ Inclinare l'unità sul retro.
2. ➤ Svitare 3 viti (3) con manicotti distanziatori (2).
3. ➤ Rimuovere 3 protezioni di trasporto (1) e riporle in modo sicuro.
4. ➤ Conservare in un luogo sicuro le viti, i manicotti distanziatori e la protezione di trasporto.

5.3 Installazione e collegamento della centrifuga

Installazione della centrifuga



AVVERTIMENTO

Rischio di lesioni a causa della distanza insufficiente dalla centrifuga.

- Durante una centrifugazione, secondo la norma EN / IEC 61010-2-020, non devono essere presenti persone, sostanze e oggetti pericolosi in un'area di **sicurezza di 300 mm** intorno alla centrifuga.
- È necessario mantenere una distanza di **300 mm** dalle fessure di ventilazione e dalle bocchette della centrifuga.



ATTENZIONE

Rischio di schiacciamento e di danneggiamento dell'apparecchio per caduta a causa dei cambiamenti di posizione provocati dalle vibrazioni.

- Posizionare l'apparecchio su una superficie stabile e piana.
- Scegliere la superficie di installazione in base al peso dell'apparecchio.



AVVISO

Danneggiamento dei campioni e dell'apparecchio a causa del superamento o dell'abbassamento della temperatura ambiente massima consentita.

- Rispettare la temperatura ambiente massima e minima ammessa per l'installazione dell'apparecchio.
- Non collocare l'apparecchio vicino a fonti di calore.
- Non esporre l'apparecchio alla luce diretta del sole.
- Non esporre l'apparecchio al gelo.

Personale:

- Utente formato

1. > Posizionare l'apparecchio su una superficie stabile e piana.
2. > Mantenere una distanza libera di 300 mm intorno all'apparecchio.
3. > Rispettare le condizioni ambientali riportate nei dati tecnici (→ *Capitolo 3.1 «Dati tecnici» a pag. 9*).

Collegamento della centrifuga



AVVISO

Danneggiamento dell'apparecchio da parte di personale non autorizzato

- La manomissione e la modifica dell'apparecchio da parte di persone non autorizzate sono a rischio e pericolo dell'utilizzatore e comportano la perdita di tutti i diritti di garanzia e di responsabilità.



AVVISO

Danni all'apparecchio dovuti alla condensa.

In presenza di una differenza di temperatura tra freddo e caldo, sussiste il rischio di formazione di condensa sui componenti elettrotecnici. La condensa che si forma può causare un cortocircuito o distruggere i componenti elettronici.

- Riscaldare l'apparecchio per almeno 3 ore in una stanza calda prima di collegarlo alla rete elettrica.
oppure
- riscaldarlo per 30 minuti in una stanza fredda.

Personale:

- Utente formato

1. ➤ Se l'unità è protetta anche da un interruttore differenziale nell'impianto dell'edificio, è necessario utilizzare un interruttore differenziale di tipo B.
Se si utilizza un tipo diverso, l'interruttore differenziale potrebbe non spegnere l'unità in caso di guasto, oppure spegnerla anche se non è presente alcun guasto.
2. ➤ Verificare che la tensione di rete corrisponda alle specifiche riportate sulla targhetta.
3. ➤ Collegare l'unità a una presa di corrente standardizzata utilizzando il cavo di rete.

5.4 Accensione e spegnimento della centrifuga

Accensione della centrifuga

Personale:

- Utente formato
- Posizionare l'interruttore di rete sulla posizione [I].
➔ A seconda del tipo di centrifuga, i pulsanti lampeggiano.
Vengono mostrati gli ultimi dati di centrifugazione utilizzati.

Spegnimento della centrifuga

Il rotore è fermo.

- Posizionare l'interruttore di rete sulla posizione [0].

6 Funzionamento

6.1 Apertura e chiusura del coperchio

Apertura del coperchio

Personale:

- Utente formato
- La centrifuga è accesa.
- Il rotore è fermo.

1. ➤ Ruotare verso l'alto la barra della maniglia sul coperchio.
➔ Appare l'indicazione «Coperchio aperto».
2. ➤ Aprire il coperchio.

Chiusura del coperchio



AVVISO

Danni all'apparecchio causati dal coperchio che viene chiuso sbattendo.

- Chiudere il coperchio lentamente.
- Non sbattere il coperchio.

Personale:

- Utente formato
- Chiudere il coperchio e ruotare la maniglia verso il basso.
➔ Appare l'indicazione «Coperchio chiuso».

6.2 Montaggio e smontaggio del rotore

Smontaggio del rotore con il dado di serraggio

Personale:

- Utente formato

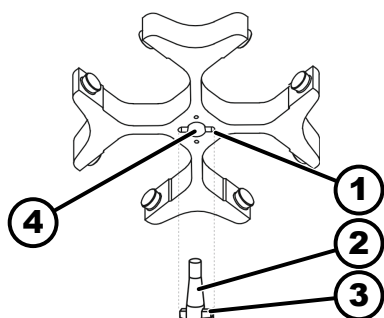

Fig. 15: Montaggio e smontaggio del rotore

- 1 Dado
- 2 Albero motore
- 3 Trascinatore
- 4 Foro

Montaggio del rotore con il dado di serraggio

1. ➤ Aprire il coperchio.
2. ➤ Allentare il dado di fissaggio del rotore con la chiave in dotazione.
 - Dopo aver superato il punto di pressione di sollevamento, il rotore si stacca dal cono dell'albero motore (2).
3. ➤ Ruotare il dado di serraggio fino a quando il rotore può essere sollevato dall'albero motore.
4. ➤ Rimuovere il rotore.

Personale:

- Utente formato

Il coperchio è aperto.

1. ➤ Pulire l'albero motore (2) e il foro del rotore (4).
2. ➤ Lubrificare leggermente l'albero motore (2), vedere ➔ *Capitolo 8.2 «Istruzioni per la pulizia e la disinfezione» a pag. 31.*
3. ➤ Posizionare il rotore in verticale sull'albero motore (2).
Il trascinatore (3) dell'albero motore deve trovarsi nella scanalatura (1) del rotore. L'orientamento della scanalatura è indicato sul rotore.
4. ➤ Serrare a mano il dado di fissaggio del rotore con la chiave in dotazione.
5. ➤ Controllare la tenuta del rotore.

Smontaggio del rotore senza il dado di serraggio

Smontaggio del rotore

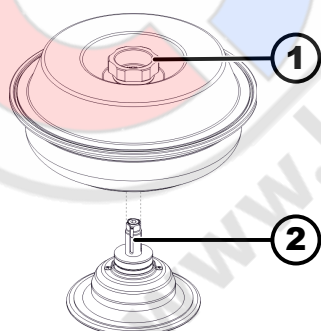

Fig. 16: Montaggio e smontaggio del rotore

- 1 Manopola rotante
- 2 Mozzo

Personale:

- Utente formato

- Tenere il rotore per la manopola rotante (1) del coperchio e sollevarlo dal mozzo (2).

Smontaggio del mozzo

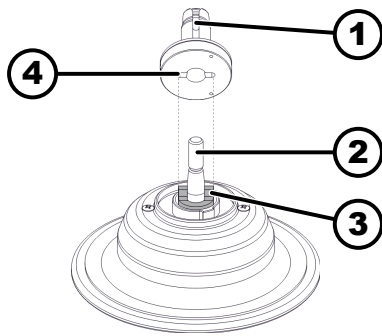

1. ➤ Aprire il coperchio.
2. ➤ Svitare il dado di fissaggio.
 - ➔ Dopo aver superato il punto di pressione di sollevamento, il mozzo (1) si stacca dal cono dell'albero motore (2).
3. ➤ Rimuovere il mozzo.

Fig. 17: Montaggio e smontaggio del mozzo

- 1 Mozzo
- 2 Albero motore
- 3 Trascinatore
- 4 Dado

Montaggio del rotore senza il dado di serraggio

Montaggio del mozzo

Personale:

- Utente formato

1. ➤ Aprire il coperchio.
2. ➤ Pulire l'albero motore (2) e il foro del rotore.
3. ➤ Lubrificare leggermente l'albero motore (2), vedere ➔ *Capitolo 8.2 «Istruzioni per la pulizia e la disinfezione» a pag. 31.*
4. ➤ Posizionare il mozzo (1) in verticale sull'albero motore (2).
Il trascinatore (3) dell'albero motore deve trovarsi nella scanalatura (4) del mozzo.
Controllare la tenuta del mozzo.
5. ➤ Serrare a mano il dado di serraggio del mozzo con la chiave a perno esagonale in dotazione.
6. ➤ Controllare la tenuta del mozzo.

Montaggio del rotore

1. ➤ Pulire il mozzo (2).
2. ➤ Sollevare il rotore dalla manopola rotante e posizionarlo verticalmente sul mozzo (2).
3. ➤ Spingere il rotore verso il basso fino all'arresto.

6.3 Inserimento e rimozione dei supporti

Inserimento dei supporti



AVVISO

Danni all'apparecchio dovuti a squilibri causati da un carico errato del rotore.

- Caricare tutti i punti dei rotori oscillanti con supporti uguali.



I supporti contrassegnati con il numero del posto del rotore possono essere utilizzati solo lì.

I supporti contrassegnati con un numero fisso possono essere utilizzati solo insieme.

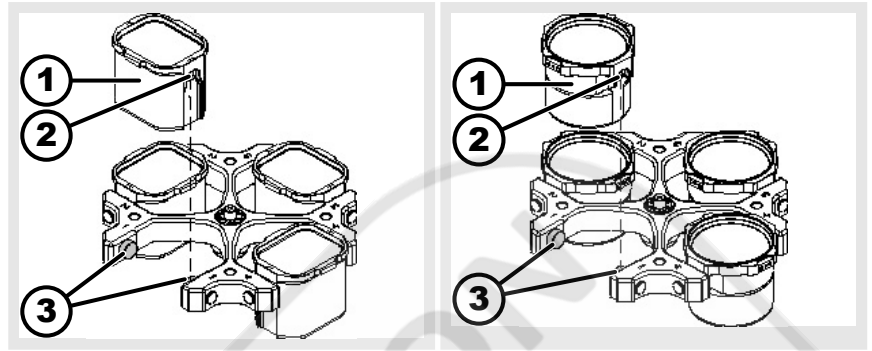

1. ➤ Controllare la tenuta del rotore.
 2. ➤ Lubrificare i perni di supporto (3).
 3. ➤ Introdurre i supporti (1) dall'alto nel rotore. I perni di supporto (3) devono trovarsi nelle scanalature (2).
 4. ➤ Spingere i supporti (1) verso il basso fino all'arresto.
- Estrarre i supporti (1) verticalmente verso l'alto dal rotore.

Rimozione dei supporti

6.4 Inserimento e rimozione dell'adattatore

Inserimento

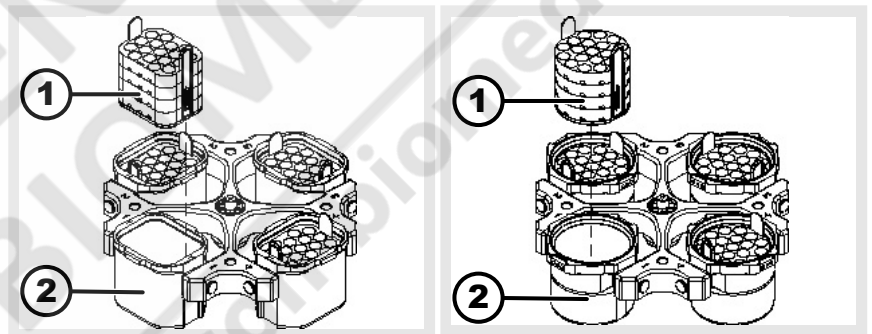

dell'adattatore

- Inserire l'adattatore (1) verticalmente dall'alto nei supporti (2).

Rimozione

- Estrarre l'adattatore (1) verticalmente dal supporto (2) tirandolo verso l'alto.

Adattatore con perno di posizionamento

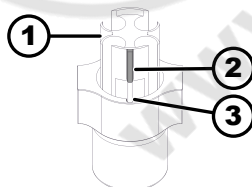

Fig. 18: Adattatore con perno di posizionamento

- 1 Inserimento
- 2 Perno di posizionamento
- 3 Inserimento

del dado

- ➔ Inserire l'adattatore (1) nel supporto
- Il perno di posizionamento (2) deve trovarsi nella scanalatura (3) del supporto.

Rimozione

- ➔ Estrarre l'adattatore (1) verticalmente dal supporto tirandolo verso l'alto.

6.5 Caricamento

Riempimento delle provette per centrifuga



AVVERTIMENTO

Rischio di lesioni dovute a materiale di campionamento contaminato.

Il materiale contaminato del campione fuoriesce dal recipiente durante la centrifugazione.

- Utilizzare solo provette per centrifuga con tappi a vite speciali per sostanze pericolose.
- Per i materiali dei gruppi di rischio 3 e 4, oltre alle provette per centrifuga richiudibili con tappo a vite, è necessario utilizzare un sistema di biosicurezza (consultare il "Laboratory Biosafety Manual" dell'OMS).



AVVISO

Danneggiamento dell'apparecchio a causa di sostanze altamente corrosive.

Le sostanze altamente corrosive possono compromettere la resistenza meccanica di rotori, supporti e accessori.

- Non centrifugare sostanze altamente corrosive.



Le provette da centrifuga in vetro standard possono essere caricate fino a RZB 4000 (DIN 58970 parte 2).

Personale:

- Utente formato

- ➔ Riempire le provette per centrifuga fuori dalla centrifuga.

La quantità massima di riempimento delle provette per centrifuga specificata dal produttore non deve essere superata.

Nel caso di rotori angolari, le provette per centrifuga possono essere riempite solo nella misura in cui il liquido non può essere espulso dalle provette durante la centrifugazione.

Per ridurre al minimo le differenze di peso all'interno delle provette per centrifuga, assicurarsi che le provette siano riempite in modo omogeneo.

Caricamento dei rotori oscillanti

Personale:

- Utente formato

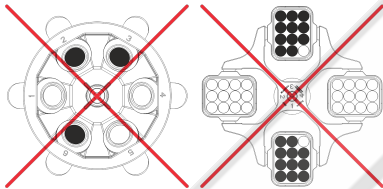
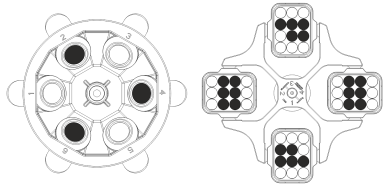
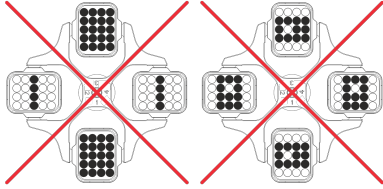
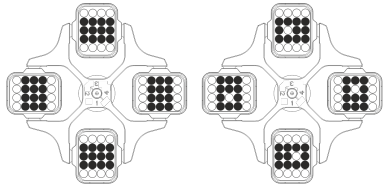

Caricamento dei rotori angolari

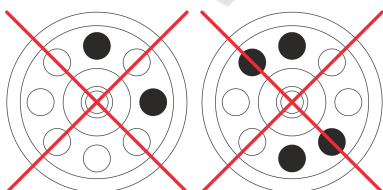
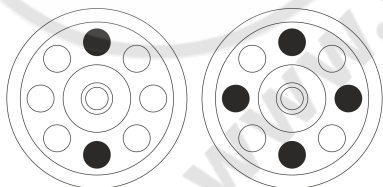
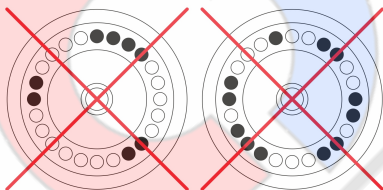
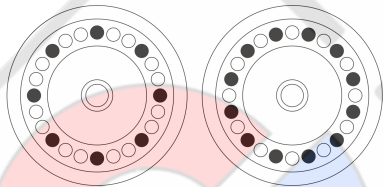

1. ➤ Controllare la tenuta del rotore.
2. ➤ Le provette per centrifuga devono essere distribuite in modo simmetrico e uniforme in tutti i punti del rotore.

Il peso della quantità di riempimento ammessa è indicato su ogni rotore. Non superare il peso consentito.

Quando si caricano i supporti e li si fa oscillare durante la centrifugazione, non deve penetrare alcun liquido nei supporti e nella camera di centrifugazione.

Per i contenitori con inserti in gomma, sotto le provette per centrifuga deve esserci sempre lo stesso numero di inserti in gomma.

Tutti i posti sul rotore devono essere occupati dallo stesso numero di supporti. Alcuni supporti sono contrassegnati con il numero del posto del rotore. I supporti possono essere inseriti solo nel posto corrispondente del rotore.

I supporti contrassegnati con un numero di set (ad esempio S001/4) possono essere utilizzati solo nel set.

Personale:

- Utente formato

1. ➤ Controllare la tenuta del rotore.
2. ➤ Le provette per centrifuga devono essere distribuite in modo uniforme in tutti i punti del rotore.

Quando si carica il rotore, non deve penetrare alcun liquido nel rotore e nella camera di centrifugazione.

Nel caso di rotori, le provette per centrifuga possono essere riempite solo nella misura in cui il liquido non può essere espulso dalle provette durante la centrifugazione.

Il peso della quantità di riempimento ammessa è indicato su ogni rotore. Non superare il peso consentito.

6.6 Apertura e chiusura del sistema di biosicurezza

6.6.1 Spiegazione

Quando si centrifugano sostanze pericolose o miscele di sostanze tossiche, radioattive o contaminate da microrganismi patogeni, l'utilizzatore è tenuto ad adottare misure adeguate.

È necessario utilizzare sempre provette per centrifuga con tappi a vite speciali per sostanze pericolose.

Per i materiali dei gruppi di rischio 3 e 4, oltre alle provette per centrifuga richiudibili con tappo a vite, è necessario utilizzare un sistema di biosicurezza (consultare il "Laboratory Biosafety Manual" dell'Organizzazione Mondiale della Sanità).

In un sistema di biosicurezza, un bio-sigillo (anello di tenuta) impedisce la fuoriuscita di gocce e aerosol.

Se il supporto di un sistema di biosicurezza viene utilizzato senza il coperchio, l'anello di tenuta deve essere rimosso dal supporto per evitare di danneggiarlo durante la centrifugazione.

I sistemi di biosicurezza danneggiati non sono più a tenuta microbiologica.

Senza l'utilizzo di un sistema di biosicurezza, una centrifuga non è a tenuta microbiologica ai sensi della norma EN / IEC 61010-2-020.

Stoccaggio dei sistemi di biosicurezza

Per evitare di danneggiare gli anelli di tenuta durante lo stoccaggio, i sistemi di biosicurezza devono essere conservati sempre con il coperchio aperto.

6.6.2 Coperchio con tappo a vite

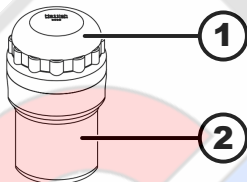

Fig. 19: Sistema di biosicurezza

- 1 Coperchio
- 2 Supporto

Chiusura

1. ➤ Posizionare il coperchio (1) al centro del supporto (2).
2. ➤ Ruotare il coperchio (1) in senso orario fino a chiuderlo saldamente.

Apertura

1. ➤ Ruotare il coperchio (1) in senso antiorario fino ad aprirlo.
2. ➤ Rimuovere il coperchio (1) dal supporto (2).

6.7 Centrifugazione

6.7.1 Centrifugazione in funzionamento continuo

Personale:

- Utente formato

1. ➤ Impostare la velocità desiderata con i pulsanti [RPM/RCF x 100].
2. ➤ Utilizzare i tasti [t] per impostare il tempo su zero.
 - Viene mostrato «"--"».

3.  Premere il pulsante *[START]*.
 - Il ciclo di centrifugazione viene avviato.

L'indicatore «*Rotazione*» si accende ruotando finché il rotore gira. Il conteggio del tempo inizia da 0. Il primo minuto viene conteggiato in secondi, quindi viene visualizzato il tempo in minuti. Se l'ora è visualizzata in minuti, accanto al numero lampeggia un punto.



Durante la centrifugazione, vengono mostrati la velocità del rotore o il valore RCF risultante e il tempo trascorso.
4.  Premere il pulsante *[STOP]* per interrompere il ciclo di centrifugazione. Il run-out avviene con il livello di frenata impostato. Viene mostrato il livello di frenata.

Quando il rotore si ferma, viene emesso un segnale acustico.

6.7.2 Centrifugazione con preselezione del tempo

Personale:

- Utente formato

1.  Impostare la velocità desiderata con i pulsanti *[RPM/RCF x 100]*.
2.  Impostare il tempo desiderato con i pulsanti *[t]*.
3.  Premere il pulsante *[START]*.
 - Il ciclo di centrifugazione viene avviato.

L'indicatore «*Rotazione*» si accende ruotando finché il rotore gira. Il tempo viene mostrato in minuti. L'ultimo minuto viene conteggiato alla rovescia in secondi. Se l'ora è visualizzata in minuti, accanto al numero lampeggia un punto.



Durante la centrifugazione, vengono mostrati la velocità del rotore o il valore RCF risultante e il tempo rimanente.
4.  Allo scadere del tempo o se la centrifugazione viene interrotta premendo il pulsante *[STOP]*, il run-out avviene con il livello di frenata selezionato.

Quando il rotore si ferma, viene emesso un segnale acustico.

6.7.3 Centrifugazione breve

Personale:

- Utente formato

1.  Impostare la velocità desiderata con i pulsanti *[RPM/RCF x 100]*.
2.  Premere e tenere premuto il tasto *[IMPULSE]*.
 - Il ciclo di centrifugazione viene avviato.

L'indicatore «*Rotazione*» si accende ruotando finché il rotore gira. Il conteggio del tempo inizia da 0. Il primo minuto viene conteggiato in secondi, quindi viene visualizzato il tempo in minuti. Se l'ora è visualizzata in minuti, accanto al numero lampeggia un punto.

Durante la centrifugazione, vengono visualizzati la velocità del rotore e il tempo trascorso.

3. ➤ Rilasciare il pulsante *[IMPULSE]* per interrompere il ciclo di centrifugazione.
 - Il run-out avviene con il livello di frenata impostato. Viene mostrato il livello di frenata.

Quando il rotore si ferma, viene emesso un segnale acustico.

7 Funzionamento del software

7.1 Parametri di centrifugazione

7.1.1 Impostazione del livello di frenata

1. ➤ Spegnerne l'interruttore di rete.
2. ➤ Tenere premuti contemporaneamente il pulsante ▲ *[RPM/RCF x 100]* e il pulsante *[IMPULSE]*.
3. ➤ Inserire l'interruttore di rete e rilasciare i pulsanti.
 - Premere ripetutamente il pulsante ▲ *[RPM/RCF x 100]* finché l'indicatore della velocità non visualizza la versione della macchina e l'indicatore dell'ora non visualizza il livello di frenata impostato (o «0» o «1»).

La versione della macchina è impostata di fabbrica e non può essere modificata.

La versione della macchina è impostata di fabbrica e non può essere modificata.
4. ➤ Impostare il livello di frenata desiderato con i pulsanti *[t]*.
 - Livello 1 = tempo di decelerazione breve.
 - Livello 0 = tempo di decelerazione lungo.
5. ➤ Premere il pulsante *[STOP]* per salvare le impostazioni.

7.1.2 Accelerazione relativa della centrifuga RCF

L'accelerazione relativa della centrifuga RCF dipende dalla velocità e dal raggio di centrifugazione.

L'accelerazione relativa della centrifuga RCF è data come un multiplo dell'accelerazione dovuta alla gravità (g).

L'accelerazione relativa della centrifuga RCF è un valore numerico privo di unità e viene utilizzato per confrontare le prestazioni di separazione e sedimentazione.

$$RCF = \left(\frac{RPM}{1000} \right)^2 * r * 1,118$$

$$RPM = \sqrt{\frac{RCF}{r * 1,118}} * 1000$$

RCF = accelerazione relativa della centrifuga

RPM = velocità (giri/min.)

r = raggio di centrifugazione in mm = distanza dal centro dell'asse di rotazione al fondo della provetta per centrifuga.

Visualizzazione dell'accelerazione relativa della centrifuga (RCF)

1. ➤ Durante la centrifugazione, tenere premuto il tasto *[RCF]*.
 - Viene mostrata l'accelerazione relativa della centrifuga (RCF).

2. ➤ Rilasciare il pulsante *[RCF]*.
➔ Viene mostrata la velocità.

7.1.3 Centrifugazione di sostanze o miscele di sostanze con una densità superiore a 1,2 kg/dm³

Quando si centrifuga alla massima velocità, la densità delle sostanze o delle miscele di sostanze non deve superare 1,2 kg/dm³. Per le sostanze o le miscele di sostanze con una densità maggiore, la velocità deve essere ridotta. La velocità consentita può essere calcolata secondo la seguente formula:

$$\text{numero di giri ridotto } (n_{red}) = \sqrt{\frac{1,2}{\text{densità maggiore [kg/dm}^3\text{]} * \text{regime massimo di rotazione [RPM]}}$$

Ad esempio: Velocità massima 4000 giri/min., densità 1,6 kg/dm³

$$n_{red} = \sqrt{\frac{1,2(\text{kg/dm}^3)}{1,6(\text{kg/dm}^3)} * 4000 \text{ RPM}} = 3464 \text{ RPM}$$

Se, in casi eccezionali, si supera il carico massimo indicato sul supporto, anche la velocità deve essere ridotta. La velocità consentita può essere calcolata secondo la seguente formula:

$$\text{numero di giri ridotto } (n_{red}) = \sqrt{\frac{\text{carico massimo [g]}}{\text{carico effettivo [g]}} * \text{regime massimo di rotazione [RPM]}}$$

Ad esempio: Velocità massima 4000 giri/min., carico massimo 300 g, carico effettivo 350 g

$$n_{red} = \sqrt{\frac{300 \text{ g}}{350 \text{ g}} * 4000 \text{ RPM}} = 3703 \text{ RPM}$$

In caso di dubbi, contattare il produttore.

7.1.4 Raggio di centrifugazione

Il raggio di centrifugazione deve essere inserito in centimetri.

1. ➤ Spegnere l'interruttore di rete.
2. ➤ Tenere premuti contemporaneamente il pulsante ▲ *[RPM/RCF x 100]* e il pulsante *[IMPULSE]*.
3. ➤ Inserire l'interruttore di rete e rilasciare i pulsanti.
4. ➤ Premere il pulsante ▲ *[RPM/RCF x 100]* finché non appaiono il raggio di centrifugazione e «rd».
5. ➤ Impostare il raggio di centrifugazione desiderato con i pulsanti *[t]*.
6. ➤ Premere il pulsante *[STOP]* per salvare le impostazioni.

7.2 Rilevamento del rotore

- Dopo l'avvio di un ciclo di centrifugazione, viene eseguito un rilevamento del rotore.
- Se il rotore è stato cambiato, la centrifugazione viene interrotta dopo il rilevamento del rotore. Appare il codice del rotore (rosso).
- Se la velocità massima del rotore utilizzato è inferiore alla velocità impostata, la velocità viene limitata alla velocità massima del rotore.

7.3 Machine Menu

7.3.1 Segnale acustico

7.3.1.1 Generalità

Il segnale acustico viene emesso:

- dopo il verificarsi di un malfunzionamento a intervalli di 2 secondi.
- dopo il completamento del ciclo centrifugazione e l'arresto del rotore a intervalli di 30 secondi.

L'apertura del coperchio o la pressione di un qualsiasi pulsante interrompe il segnale acustico.

7.3.1.2 Impostazione del segnale acustico

1. ➔ Spegnere l'interruttore di rete.
2. ➔ Tenere premuti contemporaneamente il pulsante ▲ [RPM/RCF x 100] e il pulsante [IMPULSE].
3. ➔ Inserire l'interruttore di rete e rilasciare i pulsanti.
4. ➔ Premere il pulsante ▲ [RPM/RCF x 100] finché non appare il parametro «BEL 1» o «BEL 0».
5. ➔ Utilizzare i pulsanti [t] sotto l'indicatore dell'ora per impostare «0» o «1».
 - 0 = segnale acustico disattivato.
 - 1 = segnale acustico attivato.
6. ➔ Premere il pulsante [STOP] per salvare le impostazioni.

8 Pulizia e cura

8.1 Tabella riassuntiva

Cap.	Interventi da effettuare	all'occorrenza	quotidianamente	settimanalmente	Annualmente	Pag.
8	Pulizia e cura					30
8.3	Pulizia					32
8.3	Pulire l'apparecchio		X			32
8.3	Pulire i sistemi di biosicurezza			X		32
8.3	Pulire gli accessori			X		32
8.4	Disinfezione					32
8.4	Disinfettare l'apparecchio	X				32
8.4	Disinfettare gli accessori	X				33

Cap.	Interventi da effettuare	all'occorrenza	quotidianamente	settimanalmente	Annualmente	Pag.
8.5	Manutenzione					33
8.5	Lubrificazione della guarnizione in gomma della camera di centrifuga			X		33
8.5	Ingrassare la guarnizione in gomma del sistema di biosicurezza			X		33
8.5	Lubrificazione dei perni di supporto			X		33
8.5	Controllare gli accessori			X		34
8.5	Controllo del sistema di biosicurezza			X		34
8.5	Controllare che la camera centrifuga non presenti danni				X	34
8.5	Lubrificazione dell'albero motore				X	34
8.5	Accessori con durata di utilizzo limitata	X				34
8.5	Sostituzione delle provette per centrifuga	X				34

8.2 Istruzioni per la pulizia e la disinfezione



PERICOLO

Rischio di contaminazione per l'utilizzatore a causa di una pulizia insufficiente o della mancata osservanza delle istruzioni di pulizia.

- Osservare le istruzioni per la pulizia.
- Indossare i dispositivi di protezione individuale durante la pulizia dell'apparecchio.
- Osservare le norme di laboratorio (ad esempio TRBA, IfSG, piano di igiene) per la manipolazione di agenti biologici.

- L'apparecchio e gli accessori non devono essere lavati in lavastoviglie.
- Eseguire solo la pulizia delle mani e la disinfezione con liquidi.
- La temperatura dell'acqua massima consentita è di 25 °C.
- Per evitare la corrosione causata da detersivi o disinfettanti, è essenziale seguire le istruzioni speciali per l'uso fornite dal produttore del detersivo o del disinfettante.

Disinfettanti:

- Disinfettanti per superfici (non disinfettanti per mani o strumenti)
- Etanolo come unico principio attivo.

Non disinfettare il vetro spia nel coperchio dell'apparecchio utilizzando miscele di etanolo-propanolo.

- Concentrazione non inferiore al 30 %
- Valore pH: 6 – 8
- Non corrosivo

8.3 Pulizia

Pulire l'apparecchio

1. ➤ Aprire il coperchio.
2. ➤ Spegnerne l'apparecchio e scollegarlo dall'alimentazione.
3. ➤ Togliere gli accessori.
4. ➤ Pulire l'alloggiamento e la camera di centrifuga con sapone o un detergente delicato e un panno umido.
5. ➤ Dopo l'uso di detersivi, rimuovere i residui dello stesso strofinando con un panno umido.
6. ➤ Le superfici devono essere asciugate immediatamente dopo la pulizia.
7. ➤ Se si forma condensa, asciugare la camera di centrifuga con un panno assorbente.

Pulire i sistemi di biosicurezza

1. ➤ Pulire il sistema di biosicurezza con un detergente e un panno umido.
2. ➤ Dopo l'uso di detersivi, rimuovere i residui dello stesso strofinando con un panno umido.
3. ➤ Asciugare gli accessori subito dopo la pulizia con un panno privo di lanugine e aria compressa priva di olio. Asciugare completamente tutte le cavità con aria compressa priva di oli.

Pulire gli accessori

1. ➤ Pulire gli accessori con un detergente e un panno umido.
2. ➤ Dopo l'uso di detersivi, rimuovere i residui dello stesso strofinando con un panno umido.
3. ➤ Asciugare gli accessori subito dopo la pulizia con un panno privo di lanugine e aria compressa priva di olio. Asciugare completamente tutte le cavità con aria compressa priva di oli.

8.4 Disinfezione



La disinfezione deve essere sempre preceduta dalla pulizia dei componenti interessati.

Vedere ➔ Capitolo 8.3 «Pulizia» a pag. 32



Concentrazione e tempo di esposizione del disinfettante secondo le istruzioni del produttore.

Disinfettare l'apparecchio



ATTENZIONE

Pericolo di ferimento dovuto all'ingresso di acqua o altri liquidi.

- Proteggere l'unità dai liquidi provenienti dall'esterno.
- Non disinfettare a spruzzo l'apparecchio.

1. ➤ Aprire il coperchio.

2. ➤ Spegnere l'apparecchio e scollegarlo dall'alimentazione.
3. ➤ Togliere gli accessori.
4. ➤ Pulire l'alloggiamento e la camera di centrifuga con un disinfettante.
5. ➤ Dopo l'uso di disinfettanti, rimuoverne i residui strofinando con un panno umido.
6. ➤ Le superfici devono essere asciugate immediatamente dopo la pulizia.

Disinfettare gli accessori

1. ➤ Disinfettare gli accessori con il disinfettante.
2. ➤ Inumidire tutte le cavità con il disinfettante senza creare bolle d'aria.
3. ➤ Dopo aver utilizzato il disinfettante, lasciar asciugare i residui del disinfettante o rimuoverli.

Sterilizzazione in autoclave

I seguenti accessori possono essere sterilizzati in autoclave a 121 °C / 250 °F (20 min):

- Rotori oscillanti
- Rotori angolari in alluminio
- Supporti in metallo
- Coperchio con biocontenitore
- Inserimento

Non è possibile fare dichiarazioni sul grado di sterilità.

I coperchi dei rotor e dei supporti devono essere rimossi prima della sterilizzazione in autoclave.

La sterilizzazione in autoclave accelera il processo di invecchiamento dei materiali. Può provocare lo scolorimento. Dopo la sterilizzazione in autoclave, controllare visivamente che i rotor e gli accessori non siano danneggiati e sostituire immediatamente le parti danneggiate.

In caso di fessure, segni fragilità o di usura, l'anello di tenuta in questione deve essere sostituito. Per i coperchi con anelli di tenuta non sostituibili, è necessario sostituire l'intero coperchio.

Per garantire la chiusura stagna dei sistemi di biosicurezza, si devono sostituire le guarnizioni anulari dopo la sterilizzazione in autoclave.

8.5 Manutenzione

Lubrificazione della guarnizione in gomma della camera di centrifuga

- Strofinare leggermente l'anello di tenuta con un prodotto per la cura della gomma.

Ingrassare la guarnizione in gomma del sistema di biosicurezza

- Strofinare leggermente l'anello di tenuta con un prodotto per la cura della gomma.

Lubrificazione dei perni di supporto

1. ➤ Rimuovere gli accessori.
2. ➤ Pulire i perni di supporto.
3. ➤ Dopo l'uso di detergenti, rimuovere i residui dello stesso strofinando con un panno umido.
4. ➤ Ingrassare i perni di supporto e i supporti delle scanalature con il prodotto Hettich Tubenfett 4051.
5. ➤ Il lubrificante in eccesso nella camera di centrifuga deve essere rimosso.

Controllare gli accessori

1. ➤ Controllare che gli accessori non presentino danni da usura e corrosione.
2. ➤ Controllare la tenuta del rotore.

Controllo del sistema di biosicurezza

1. ➤ Controllare visivamente che tutte le parti del sistema di biosicurezza non siano danneggiate.
2. ➤ Controllare la corretta posizione di installazione degli anelli di tenuta del sistema di biosicurezza.
3. ➤ Sostituire le parti danneggiate del sistema di biosicurezza.
4. ➤ In caso di fessure, segni di fragilità o di usura, l'anello di tenuta in questione deve essere sostituito immediatamente. Per i coperchi con anelli di tenuta non sostituibili, è necessario sostituire l'intero coperchio.

Controllare che la camera centrifuga non presenti danni

- Controllare che la camera centrifuga non presenti danni.

Lubrificazione dell'albero motore

1. ➤ Rimuovere gli accessori.
2. ➤ Pulizia dell'albero motore.
3. ➤ Dopo l'uso di detergenti, rimuovere i residui dello stesso strofinando con un panno umido.
4. ➤ Lubrificazione dell'albero motore con il prodotto Hettich Tubenfett 4051.
5. ➤ Il lubrificante in eccesso nella camera di centrifuga deve essere rimosso.

Accessori con durata di utilizzo limitata

L'utilizzo di alcuni accessori è limitato nel tempo. Per motivi di sicurezza, gli accessori non devono più essere utilizzati quando è stato raggiunto il numero massimo di cicli di funzionamento indicato su di essi o la data di scadenza indicata su di essi.

- Il numero massimo di cicli di funzionamento consentiti o la data di scadenza sono riportati sugli accessori.

Sostituzione delle provette per centrifuga



ATTENZIONE

Rischio di lesioni a causa di schegge di vetro.

La rottura del vetro può causare la presenza di schegge di vetro e liquidi contaminati all'interno della centrifuga.

- Indossare guanti antitaglio.
- Indossare gli occhiali di sicurezza e una mascherina.

In caso di perdita o di rottura delle provette per centrifuga, le parti rotte della provetta, le schegge di vetro e il materiale centrifugo versato devono essere rimossi completamente. Le schegge di vetro rimanenti causano ulteriori rotture del vetro.

Gli inserti in gomma e le guaine in plastica dei rotori devono essere sostituiti dopo la rottura del vetro.

Se il materiale è infettivo, è necessario procedere alla disinfezione.

9 Risoluzione dei problemi

9.1 Descrizione dell'errore

Se il guasto non può essere eliminato in base alla tabella dei guasti, è necessario informare il servizio clienti. Indicare il tipo di centrifuga e il numero di serie. Entrambi i numeri sono riportati sulla targhetta della centrifuga.

Descrizione inconveniente	Causa	Rimedio
nessuna indicazione	Tensione assente. Fusibili di ingresso alla rete difettosi.	<ul style="list-style-type: none"> ■ Controllare la tensione di alimentazione. ■ Controllare il fusibile di ingresso alla rete. ■ Posizionare l'interruttore di rete sulla posizione [I].
-1-	Errore tachimetro. Guasto degli impulsi di velocità.	<ul style="list-style-type: none"> ■ Non spegnere l'unità mentre l'indicatore «Rotazione» è acceso e ruota. Attendere che compaia il simbolo «Coperchio chiuso» (dopo circa 100 secondi), quindi eseguire un RESET DI ALIMENTAZIONE.
-2-	Interruzione della rete elettrica durante la centrifugazione. Il ciclo di centrifugazione non è stato completato.	<ul style="list-style-type: none"> ■ Aprire il coperchio e premere il pulsante [START]. ■ All'occorrenza: Ripetere il ciclo di centrifugazione.
-3-	Squilibrio. Il rotore è caricato in modo non uniforme.	<ul style="list-style-type: none"> ■ Aprire il coperchio. ■ Controllare il carico del rotore. ■ Ripetere il ciclo di centrifugazione.
-4-	Comunicazione. Errore nella sezione di controllo o di potenza.	<ul style="list-style-type: none"> ■ Eseguire un RESET DI ALIMENTAZIONE.
-5-	Sovraccarico. Motore o controllo del motore difettoso.	<ul style="list-style-type: none"> ■ Eseguire un RESET DI ALIMENTAZIONE.
-6-	Sovratensione. Tensione di rete al di fuori delle tolleranze.	<ul style="list-style-type: none"> ■ Eseguire un RESET DI ALIMENTAZIONE. ■ Controllare la tensione di rete.
-7-	Sovravelocità. Errore nella sezione di alimentazione.	<ul style="list-style-type: none"> ■ Eseguire un RESET DI ALIMENTAZIONE.
-8-	Sottotensione. Tensione di rete al di fuori delle tolleranze.	<ul style="list-style-type: none"> ■ Eseguire un RESET DI ALIMENTAZIONE. ■ Controllare la tensione di rete.
-9-	Sovratemperatura. L'interruttore di sovratemperatura del motore è scattato.	<ul style="list-style-type: none"> ■ Aprire il coperchio con lo sblocco di emergenza. ■ Far raffreddare il motore.

Descrizione inconveniente	Causa	Rimedio
Version Error	Impostazione della versione della macchina errata. L'unità di controllo passa al menu di impostazione.	<ul style="list-style-type: none"> ■ Impostare la cifra 7 con i pulsanti [t]. ■ Premere il pulsante [STOP] per salvare le impostazioni. ■ Eseguire un RESET DI ALIMENTAZIONE.
nessuna indicazione della velocità. Versione della macchina impostata nell'indicatore dell'ora.	Version Error. Impostazione della versione della macchina errata. L'unità di controllo passa al menu di impostazione.	<ul style="list-style-type: none"> ■ Impostare la cifra 7 con i pulsanti [t]. ■ Premere il pulsante [STOP] per salvare le impostazioni. ■ Eseguire un RESET DI ALIMENTAZIONE.
-c-	Controller-Watchdog. Errore nella sezione di alimentazione.	<ul style="list-style-type: none"> ■ Eseguire un RESET DI ALIMENTAZIONE.
-d-	Errore blocco del coperchio.	<ul style="list-style-type: none"> ■ Eseguire un RESET DI ALIMENTAZIONE.
-E-	Cortocircuito nella sezione di controllo/alimentazione.	<ul style="list-style-type: none"> ■ Eseguire un RESET DI ALIMENTAZIONE.
-F-	Nessun rilevamento del rotore all'avvio. Rotore non inserito o tachimetro difettoso.	<ul style="list-style-type: none"> ■ Eseguire un RESET DI ALIMENTAZIONE.
rosso...	È stato rilevato un nuovo rotore.	<ul style="list-style-type: none"> ■ Premere il pulsante [START].
888888 Tutti i segmenti del display si illuminano.	-	<ul style="list-style-type: none"> ■ Notificare il servizio clienti.

9.2 Eseguire un RESET DI ALIMENTAZIONE

1. ➤ Posizionare l'interruttore di rete sulla posizione [0].
2. ➤ Attendere 10 secondi.
3. ➤ Posizionare l'interruttore di rete sulla posizione [I].

9.3 Sblocco di emergenza

In caso di interruzione di corrente, il coperchio non può essere sbloccato dal motore. È necessario procedere allo sblocco di emergenza a mano.



⚠️ AVVERTIMENTO

Rischio di scosse elettriche a causa di interventi di manutenzione e assistenza su un apparecchio sotto tensione.

- Scollegare l'unità dalla rete elettrica prima di effettuare interventi di manutenzione e riparazione.



⚠️ AVVERTIMENTO

Pericolo di taglio e schiacciamento a causa del rotore in movimento.

- Aprire il coperchio solo quando il rotore è fermo.

Personale:

- Utente formato

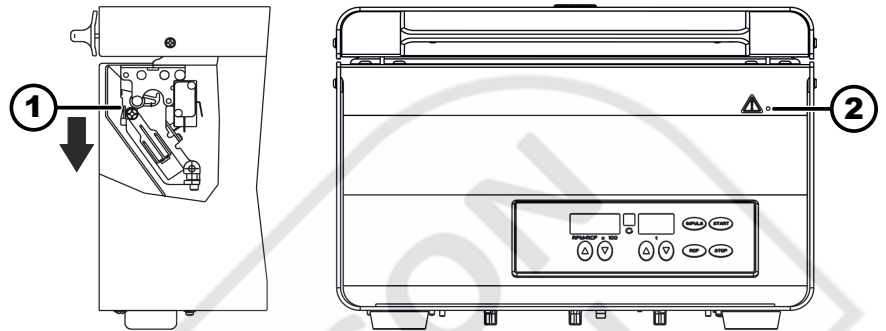

Fig. 20: Sblocco di emergenza

- 1 Perno di sblocco
- 2 Foro

1. Guardare attraverso la finestra del coperchio per assicurarsi che il rotore sia fermo.
2. Inserire il perno di sblocco (1) orizzontalmente nel foro (2). Spingere fino a quando l'impugnatura può essere ruotata verso l'alto quando il perno è premuto.
3. Aprire il coperchio.

9.4 Sostituzione del fusibile di ingresso della rete



! AVVERTIMENTO

Rischio di scosse elettriche a causa di interventi di manutenzione e assistenza su un apparecchio sotto tensione.

- Scollegare l'unità dalla rete elettrica prima di effettuare interventi di manutenzione e riparazione.

Personale:

- Utente formato

I fusibili di rete si trovano accanto all'interruttore di rete.

L'interruttore di rete è in posizione [O]

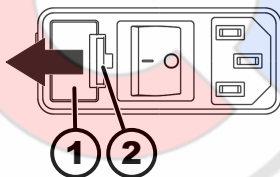

Fig. 21: Fusibile di ingresso della rete

- 1 Portafusibile
- 2 Chiusura a scatto

1. Scollegare il cavo di rete dalla spina dell'apparecchio.
2. Premere la chiusura a scatto (2) contro il portafusibili (1) ed estrarlo.
3. Sostituire i fusibili di ingresso alla rete difettosi.
Utilizzare solo fusibili con il valore nominale specificato per il tipo, vedere la tabella seguente.
4. Spingere il portafusibile (1) fino a quando la chiusura a scatto si innesta.
5. Ricollegare l'unità alla rete elettrica.

Modello	Tipo	Fusibile	Codice ordine
ROTOFIX 32 A	1206, 1206-34	T 3,15 AH/250 V	E997
ROTOFIX 32 A	1206-01, 1206-33	T 5 AH/250 V	E914

10 Smaltimento

10.1 Note generali



L'apparecchio può essere smaltito contattando il costruttore.

Per il reso richiedere sempre l'apposito modulo (RMA).

In caso di necessità contattare l'assistenza tecnica del costruttore.

- **Andreas Hettich GmbH & Co. KG**
- Föhrenstraße 12
- 78532 Tuttlingen, Germania
- Telefono: +49 7461 705 1400
- E-mail: service@hettichlab.com



! AVVERTIMENTO

Pericolo di inquinamento e contaminazione per l'uomo e l'ambiente

Uno smaltimento inappropriato o non conforme della centrifuga può essere causa di inquinamento o contaminazione per l'uomo e l'ambiente.

- Lo smontaggio e lo smaltimento devono essere effettuati esclusivamente da personale tecnico esperto e autorizzato.

L'apparecchio è destinato al settore commerciale ("Business to Business" - B2B).

Ai sensi della direttiva 2012/19/UE gli apparecchi non devono essere smaltiti insieme ai normali rifiuti.

Secondo lo Stiftung Elektro-Altgeräte Register (EAR) gli apparecchi vengono classificati nei seguenti gruppi:

- Gruppo 5 (Apparecchi di piccole dimensioni)

Il simbolo del bidone della spazzatura barrato indica che l'apparecchio non può essere smaltito insieme ai normali rifiuti. I regolamenti in materia di smaltimento dei singoli Paesi possono essere differenti. In caso di necessità contattare il fornitore.



Fig. 22: Divieto di smaltimento nei rifiuti domestici

11 Indice analitico

A

Accelerazione relativa della centrifuga	
RCF.	28
Accensione.	20
Accessori.	15
con un periodo di utilizzo limitato.	34
del rotore.	34
sistemi di biosicurezza.	32
superficie.	33
Apparecchio	
sistemi di biosicurezza.	32
superficie.	32
Attivazione/disattivazione.	30
Avvertenze di sicurezza.	7
Avvertenze di sicurezza generali.	7

C

Caricamento.	24
Centrifugazione	
con densità superiore.	29
con preselezione del tempo.	27
in funzionamento continuo.	26
Centrifugazione breve.	27
Collegamento della centrifuga.	19
Condizione di trasporto.	15
Condizioni di stoccaggio.	16
Controllare che la camera di centrifuga	
non presenti danni.	34
Controllo del	
sistema di biosicurezza.	34
Coperchio	
coperchio.	20
Cura	
Intervalli.	30

D

Disimballaggio.	17
Disinfezione.	32
Dispositivi di protezione.	6
Dispositivi di protezione individuale.	6
Dotazione.	15

E

Etichette	
sull'apparecchio.	13
sulla confezione.	12

F

Fissaggio della	
contaminanti radioattivi.	18
protezione di trasporto.	16
Formazione del personale.	7
Funzionamento continuo.	26

I

Installazione della centrifuga.	18
---	----

L

Lubrificazione	
guarnizione in gomma.	34
Lubrificazione dei	
perni di supporto.	33
Lubrificazione della	
guarnizione in gomma.	33

M

Manutenzione.	33
Intervalli.	30
Messaggi di errore.	35

P

Pezzi di ricambio.	15
Pezzi di ricambio originali.	15
Pulizia.	32
Pulizia dei	
sistemi di biosicurezza.	32
Pulizia e disinfezione	
Note.	31

Q

Qualifica del personale.	6
Qualifiche del personale.	6

R

RESET DI ALIMENTAZIONE.	36
Reso.	15
Responsabilità dell'operatore.	7
Riempimento.	24
Rilevamento del rotore.	29
Risoluzione dei problemi.	35

S

Simboli.	5
Smaltimento.	38
Smontaggio	
del rotore.	20
rotore.	24, 25
Sostituzione delle	
provette per centrifuga.	34
Spegnimento.	20
Sterilizzazione in autoclave.	33

T

Targhetta di identificazione.	11
Trouble shooting.	35











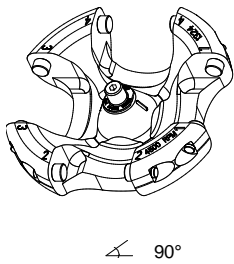
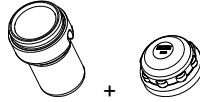



U



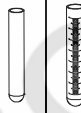







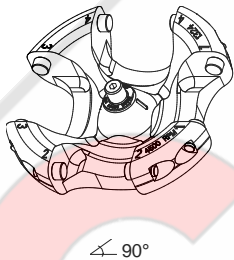





Uso improprio prevedibile.	6
Uso non previsto.	6
Uso previsto.	5



Rotoren und Zubehör / Rotors and accessories

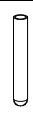





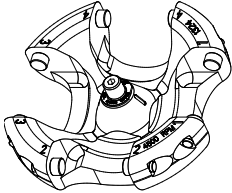
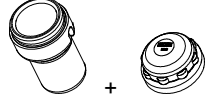

1324	1490 + 1492							
Ausschwingrotor 4-fach / Swing out rotor 4-times  ↙ 90°	 mit Bioabdichtung / with bio-containment 5)							
	---	0765		1329			1329	1330
	---							
	---	0534 4)	0535	---	---	---	---	---
---								
Kapazität / capacity	ml	30		9	15	9 - 10	10	25
Maße / dimensions	∅ x L	44 x 105		14 x 100	17 x 100	16 x 92	15 x 102	24 x 100
Anzahl p. Rotor / number p. rotor		4		16	16	16	16	4
Drehzahl / speed	RPM	4000		4000	4000	4000	4000	4000
RZB / RCF	³	2504		2504	2504	2504	2630	2397
Radius / radius	mm	140		140	140	140	147	134
 9 (97%)	sec	27						
 9	sec	30						
Probenerwärmung/Sample temp. rise	K 1)	10						

1324	1490 + 1492									
Ausschwingrotor 4-fach / Swing out rotor 4-times  ↙ 90°	 mit Bioabdichtung / with bio-containment 5)									
	1331	1339	1343	1347	1348					
										
	---	Rhesus	---	---	---	---	---	---	---	
---										
Kapazität / capacity	ml	50	1	3	4	15	10	8	4 - 4,5	4 - 7
Maße / dimensions	∅ x L	34 x 100	6 x 45	10 x 60	10 x 88	17 x 120	16 x 80	16 x 81	15 x 75	16 x 75
Anzahl p. Rotor / number p. rotor		4	108	36	4	16	16	16	16	16
Drehzahl / speed	RPM	4000	4000	4000	4000	4000	4000	4000	4000	4000
RZB / RCF	³⁾	2379	2558	2594	2630	2486	2486	2486	2486	2486
Radius / radius	mm	133	143	145	147	139	139	139	139	139
 9 (97%)	sec	27								
 9	sec	30								
Probenerwärmung/Sample temp. rise	K 1)	10								

- 1) Probenerwärmung bei maximaler Drehzahl und 1 Stunde Laufzeit (nur bei Zentrifuge ohne Kühlung)
- 3) Angaben des Röhrchenherstellers beachten.
- 4) nicht mit Stopfen zentrifugierbar, Skal. 10µl-300µl, 15ml, 30ml
- 5) Nach DIN EN 61010, Teil 2 – 020. Die Hinweise für Bio-Sicherheitssysteme in den Kapiteln "Sicherheitshinweise" und "Pflege und Wartung" beachten
- 7) Die Einlagen entfernen

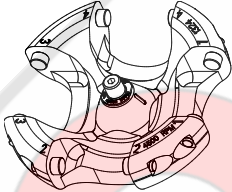









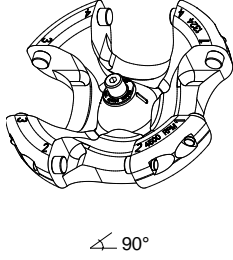
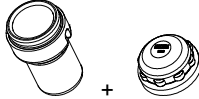





- 1) Sample temp. rise during maximum speed and 1 hour running time (only with centrifuges without cooling)
- 3) Observe the tube manufacturer's instructions.
- 4) can not be centrifugated when plug is attached, Scal. 10µl-300µl, 15ml, 30ml
- 5) in conformity with DIN EN 61010, part 2 – 020. Observe the notes for bio safety systems in chapters "Notes on safety" and "Maintenance and servicing".
- 7) Remove the inserts











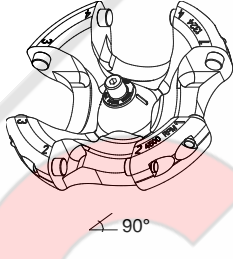

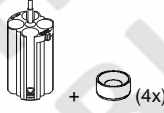

1324		1490 + 1492												
Ausschwingrotor 4-fach / Swing out rotor 4-times  $\angle 90^\circ$		 mit Bioabdichtung / with bio-containment 5)												
		1348		1351		1363		1365		1383				
		---		---		---		---		---				
Kapazität / capacity	ml	8,5 - 10	1,5	2,0	0,5	25	30	5	6	7	2,7 - 3			
Maße / dimensions $\varnothing \times L$	mm	16 x 100	11 x 38		10,7 x 36		25 x 90		25 x 110		12 x 75	12 x 82	12 x 100	11 x 66
Anzahl p. Rotor / number p. rotor		16	20		20		4		4		20		20	20
Drehzahl / speed	RPM	4000	4000		4000		4000		4000		4000		4000	4000
RZB / RCF	³⁾	2486	2415		2343		2308		2630		2522		2522	2522
Radius / radius	mm	139	135		131		129		147		141		141	141
 9 (97%)	sec	27												
 9	sec	30												
Probenerwärmung/Sample temp. rise	K ¹⁾	10												

1324		1490 + 1492							
Ausschwingrotor 4-fach / Swing out rotor 4-times  $\angle 90^\circ$		 mit Bioabdichtung / with bio-containment 5)							
		1383				1384		1396	1457
		---				---		---	---
Kapazität / capacity	ml	2,6 - 3,4	4,9	4,5 - 5	1,6 - 5	4 - 7	50	85	1,1 - 1,4
Maße / dimensions $\varnothing \times L$	mm	13 x 65	13 x 90	11 x 92	13 x 75	13 x 100	29 x 115	38 x 106	8 x 66
Anzahl p. Rotor / number p. rotor		20	20	20	20	20	4	4	28
Drehzahl / speed	RPM	4000	4000	4000	4000	4000	4000	4000	4000
RZB / RCF	³⁾	2522	2522	2522	2522	2522	2630	2576	2540
Radius / radius	mm	141	141	141	141	141	147	144	142
 9 (97%)	sec	27							
 9	sec	30							
Probenerwärmung/Sample temp. rise	K ¹⁾	10							

- 1) Probenerwärmung bei maximaler Drehzahl und 1 Stunde Laufzeit (nur bei Zentrifuge ohne Kühlung)
- 3) Angaben des Röhrchenherstellers beachten.
- 5) Nach DIN EN 61010, Teil 2 – 020. Die Hinweise für Bio-Sicherheitsysteme in den Kapiteln "Sicherheitshinweise" und "Pflege und Wartung" beachten











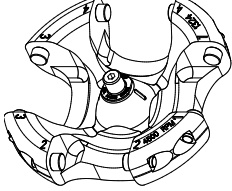

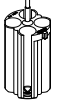
- 1) Sample temp. rise during maximum speed and 1 hour running time (only with centrifuges without cooling)
- 3) Observe the tube manufacturer's instructions.
- 5) in conformity with DIN EN 61010, part 2 – 020. Observe the notes for bio safety systems in chapters "Notes on safety" and "Maintenance and servicing".

1324	1490 + 1492									
Ausschwingrotor 4-fach / Swing out rotor 4-times  ∠ 90°	 mit Bioabdichtung / with bio-containment 5)									
	1459	4416	4417	6311	6318	1356	0761			
										
										
Kapazität / capacity	ml	4 – 5,5	7,5 – 8,2	50	30	12	50	15	100	
Maße / dimensions	∅ x L	mm	15 x 75	15 x 92	29 x 107	26 x 95	17 x 100	29 x 115	17 x 120	44 x 100
Anzahl p. Rotor / number p. rotor		16	16	4	4	4	4	12	4	
Drehzahl / speed	RPM	4000	4000	4000	4000	4000	4000	4000	4000	
RZB / RCF	³⁾	2540	2540	2594	2415	2630	2630	2630	2522	
Radius / radius	mm	142	142	145	135	147	147	147	141	
 9 (97%)	sec	27								
 9	sec	30								
Probenerwärmung/Sample temp. rise	K ¹⁾	10								

1324	1398									
Ausschwingrotor 4-fach / Swing out rotor 4-times  ∠ 90°	 ---									
	1482A + 4x 0716				1482A					
										
										
Kapazität / capacity	ml	2,6 – 3,4	4 – 4,5	9 – 10	10	12	4 - 7	8,5 – 10	9	
Maße / dimensions	∅ x L	mm	13 x 65	15 x 75	16 x 92	15 x 102	17 x 100	16 x 75	16 x 100	14 x 100
Anzahl p. Rotor / number p. rotor		16	16	16	16	16	16	16	16	
Drehzahl / speed	RPM	4000	4000	4000	4000	4000	4000	4000	4000	
RZB / RCF	³⁾	2272	2272	2522	2522	2522	2397	2397	2522	
Radius / radius	mm	127	127	141	141	141	134	134	141	
 9 (97%)	sec	27								
 9	sec	30								
Probenerwärmung/Sample temp. rise	K ¹⁾	10								











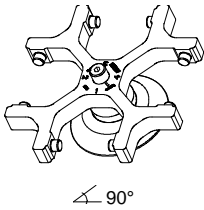

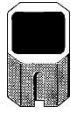



- 1) Probenerwärmung bei maximaler Drehzahl und 1 Stunde Laufzeit (nur bei Zentrifuge ohne Kühlung)
- 3) Angaben des Röhrchenherstellers beachten.
- 5) Nach DIN EN 61010, Teil 2 – 020. Die Hinweise für Bio-Sicherheitssysteme in den Kapiteln "Sicherheitshinweise" und "Pflege und Wartung" beachten
- 8) nicht mit Deckel 1492 verschließbar











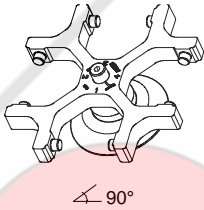

- 1) Sample temp. rise during maximum speed and 1 hour running time (only with centrifuges without cooling)
- 3) Observe the tube manufacturer's instructions.
- 5) in conformity with DIN EN 61010, part 2 – 020. Observe the notes for bio safety systems in chapters "Notes on safety" and "Maintenance and servicing".
- 7) not possible to close the lid 1492

1324		1398							
Ausschwingrotor 4-fach / Swing out rotor 4-times  		 ---							
		1482A	1483A	1484	1484	---	---	---	---
				 ohne / without E2110-A		---	---	---	---
---	---	---	Falcon®	---	---	---	---		
					---	---	---		
Kapazität / capacity	ml	15	15	50	50	---	---	---	---
Maße / dimensions	Ø x L	mm	17 x 100	17 x 120	29 x 115	29 x 115	---	---	---
Anzahl p. Rotor / number p. rotor		16	16	4	4	---	---	---	---
Drehzahl / speed	RPM	4000	4000	4000	4000	---	---	---	---
RZB / RCF	³⁾	2522	2612	2576	2576	---	---	---	---
Radius / radius	mm	141	146	144	144	---	---	---	---
 9 (97%)	sec	27			---	---	---	---	
 9	sec	30			---	---	---	---	
Probenerwärmung/Sample temp. rise	K ¹⁾	10			---	---	---	---	

- 1) Probenerwärmung bei maximaler Drehzahl und 1 Stunde Laufzeit (nur bei Zentrifuge ohne Kühlung)
 3) Angaben des Röhrchenherstellers beachten.

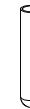









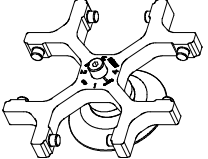
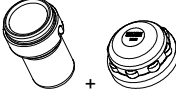





- 1) Sample temp. rise during maximum speed and 1 hour running time (only with centrifuges without cooling)
 3) Observe the tube manufacturer's instructions.











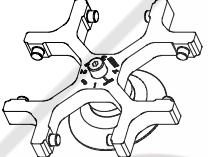
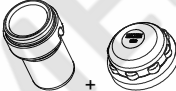



1624	---	1345	1346	1366					
Ausschwingrotor 4-fach / Swing out rotor 4-times  $\sphericalangle 90^\circ$	---								
	---	---	---	---					
	---	---	---	1326	1357	5277			
	---	---	---						
---	---	---	---	---	Rhe- sus	---	---	---	---
---									
Kapazität / capacity ml	---	45	20	4	0,4	1	3	1,5	2,0
Maße / dimensions \varnothing x L mm	---	31 x 100	21 x 100	12 x 60	6 x 45	10 x 60	11 x 38		
Anzahl p. Rotor / number p. rotor	---	4	8	48	120	36	36		
Drehzahl / speed RPM	---	4000	4000	4000	4000	4000	4000	4000	4000
RZB / RCF ³⁾	---	2361	2361	1932	1950	1968	1968	1968	1968
Radius / radius mm	---	132	132	108	109	110	110	110	110
 9 (97%) sec	22								
 9 sec	25								
Probenerwärmung/Sample temp. rise K ¹⁾	10								

1624	1369	1369-91	1369-92	1370	1372	---		
Ausschwingrotor 4-fach / Swing out rotor 4-times  $\sphericalangle 90^\circ$						---		
	---	---	---	---	---	---		
	---	---	---	---	---	---	---	
	---						---	
Kapazität / capacity ml	15	8,5 - 10	5	7	6	9	5	
Maße / dimensions \varnothing x L mm	17 x 100	16 x 100	12 x 75	12 x 100	12 x 82	14 x 100	12 x 75	
Anzahl p. Rotor / number p. rotor	16	16	16	16	16	20	68	
Drehzahl / speed RPM	4000	4000	4000	4000	4000	4000	4000	
RZB / RCF ³⁾	2308	2308	2057	2308	2308	2308	2164	
Radius / radius mm	129	129	115	129	129	129	121	
 9 (97%) sec	22							
 9 sec	25							
Probenerwärmung/Sample temp. rise K ¹⁾	10							

- 1) Probenerwärmung bei maximaler Drehzahl und 1 Stunde Laufzeit
 3) Angaben des Röhrchenherstellers beachten.

- 1) Sample temp. rise during maximum speed and 1 hour running time
 3) Observe the tube manufacturer's instructions.

1624		1481 + 1492								
Ausschwingrotor 4-fach / Swing out rotor 4-times  ↙ 90°		 mit Bioabdichtung / with bio-containment 5)								
		1329				1330		1331	1339	1347
										
		---	---	---	---	---	Rhesus	---		
										
Kapazität / capacity	ml	9	15	9 - 10	10	25	50	1	15	
Maße / dimensions	Ø x L mm	14 x 100	17 x 100	16 x 92	15 x 102	24 x 100	34 x 100	6 x 45	17 x 120	
Anzahl p. Rotor / number p. rotor		16	16	16	16	4	4	108	4	
Drehzahl / speed	RPM	4000	4000	4000	4000	4000	4000	4000	4000	
RZB / RCF	³⁾	2540	2540	2540	2540	2433	2415	2594	2665	
Radius / radius	mm	142	142	142	142	136	135	145	149	
 9 (97%)	sec	22								
 9	sec	25								
Probenerwärmung/Sample temp. rise	K ¹⁾	10								

1624		1481 + 1492							
Ausschwingrotor 4-fach / Swing out rotor 4-times  ↙ 90°		 mit Bioabdichtung / with bio-containment 5)							
		1348				1351		6311	6318
									
		---	---	---	---	---	---	Falcon®	
									
Kapazität / capacity	ml	10	4 - 7	8,5 - 10	8	1,5	2,0	0,5	12
Maße / dimensions	Ø x L mm	16 x 80	16 x 75	16 x 100	16 x 81	11 x 38	10,7 x 46	17 x 100	29 x 115
Anzahl p. Rotor / number p. rotor		16	16	16	16	20	20	4	4
Drehzahl / speed	RPM	4000	4000	4000	4000	4000	4000	4000	4000
RZB / RCF	³⁾	2522	2522	2522	2522	2451	2379	2665	2665
Radius / radius	mm	141	141	141	141	137	133	149	149
 9 (97%)	sec	22							
 9	sec	25							
Probenerwärmung/Sample temp. rise	K ¹⁾	10							

1) Probenerwärmung bei maximaler Drehzahl und 1 Stunde Laufzeit

3) Angaben des Röhrchenherstellers beachten.

5) Nach DIN EN 61010, Teil 2 – 020. Die Hinweise für Bio-Sicherheitsysteme in den Kapiteln "Sicherheitshinweise" und "Pflege und Wartung" beachten



7) Die Einlagen entfernen



1) Sample temp. rise during maximum speed and 1 hour running time

3) Observe the tube manufacturer's instructions.

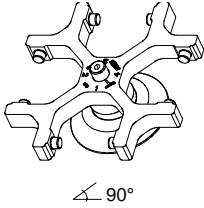
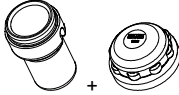
5) in conformity with DIN EN 61010, part 2 – 020. Observe the notes for bio safety systems in chapters "Notes on safety" and "Maintenance and servicing".

7) Remove the inserts

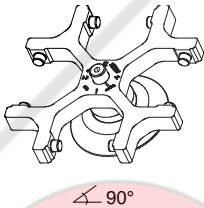
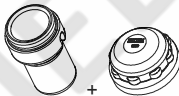
1624	1481 + 1492								
Ausschwingrotor 4-fach / Swing out rotor 4-times  $\angle 90^\circ$	 + mit Bioabdichtung / with bio-containment 5)								
	1383								
									
Kapazität / capacity	ml	6	7	4,9	4,5 - 5,0	2,7 - 3,0	2,6 - 2,9	1,6 - 5,0	5
Maße / dimensions \varnothing x L	mm	12 x 82	12 x 100	13 x 90	11 x 92	11 x 66	13 x 65	13 x 75	12 x 75
Anzahl p. Rotor / number p. rotor		20	20	20	20	20	20	20	20
Drehzahl / speed	RPM	4000	4000	4000	4000	4000	4000	4000	4000
RZB / RCF	³⁾	2558	2558	2558	2558	2558	2558	2558	2558
Radius / radius	mm	143	143	143	143	143	143	143	143
9 (97%)	sec	22							
9	sec	25							
Probenerwärmung/Sample temp. rise	K ¹⁾	10							

1624	1481 + 1492								
Ausschwingrotor 4-fach / Swing out rotor 4-times  $\angle 90^\circ$	 + mit Bioabdichtung / with bio-containment 5)								
	1383	1384	1396	1457	1343		1363	1365	
									
Kapazität / capacity	ml	4 - 7,0	50	85	1,1 - 1,4	3	4	25	30
Maße / dimensions \varnothing x L	mm	13 x 100	29 x 115	38 x 106	8 x 66	10 x 60	10 x 88	25 x 90	25 x 110
Anzahl p. Rotor / number p. rotor		20	4	4	28	36	36	4	4
Drehzahl / speed	RPM	4000	4000	4000	4000	4000	4000	4000	4000
RZB / RCF	³⁾	2558	2665	2612	2576	2630	2630	2343	2665
Radius / radius	mm	143	149	146	144	147	147	131	149
9 (97%)	sec	22							
9	sec	25							
Probenerwärmung/Sample temp. rise	K ¹⁾	10							

1) Probenerwärmung bei maximaler Drehzahl und 1 Stunde Laufzeit

5) Nach DIN EN 61010, Teil 2 – 020. Die Hinweise für Bio-Sicherheitssysteme in den Kapiteln "Sicherheitshinweise" und "Pflege und Wartung" beachten





3) Angaben des Röhrchenherstellers beachten.

1) Sample temp. rise during maximum speed and 1 hour running time

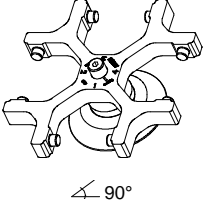
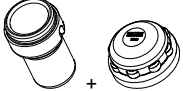
5) in conformity with DIN EN 61010, part 2 – 020. Observe the notes for bio safety systems in chapters "Notes on safety" and "Maintenance and servicing".

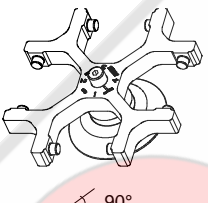
3) Observe the tube manufacturer's instructions.

1624		1481 + 1492					---	---			
Ausschwingrotor 4-fach / Swing out rotor 4-times  ↙ 90°		 +					---	---			
		mit Bioabdichtung / with bio-containment 5)									
		1459	4416	4417	0761	0765	1745	1746			
		---	---	---	---	0534 4)	0535	---	---		
Kapazität / capacity	ml	4,0 - 5,5	7,5 - 8,2	50	30	100	30	25	30	50	
Maße / dimensions	∅ x L	mm	15 x 75	15 x 92	29 x 107	26 x 95	44 x 10	44 x 105	24 x 100	26 x 95	34 x 100
Anzahl p. Rotor / number p. rotor		16	4	4	4	4	4	8	4		
Drehzahl / speed	RPM	4000	4000	4000	4000	4000	4000	4000	4000		
RZB / RCF	³⁾	2576	2630	2451	2558	2540	2540	2451	2451		
Radius / radius	mm	144	147	137	143	142	137	137	137		
9 (97%)	sec						22				
9	sec						25				
Probenerwärmung/Sample temp. rise	K ¹⁾						10				

1624		1741			1742			1739				
Ausschwingrotor 4-fach / Swing out rotor 4-times  ↙ 90°												

		0701	---	---	---	---	0716	---				
		---	---	---	---	---	---	---	---	---		
Kapazität / capacity	ml	9	1,1 - 1,4	4,9	15	15	1,6 - 5	4 - 7	2,6 - 2,9	4 - 5,5	4 - 7	
Maße / dimensions	∅ x L	mm	14 x 100	8 x 66	13 x 90	17 x 100	17 x 100	13 x 75	16 x 75	13 x 65	15 x 75	13 x 100
Anzahl p. Rotor / number p. rotor		40	40	40	28	28	28	28	28	28		
Drehzahl / speed	RPM	4000	4000	4000	4000	4000	4000	4000	4000	4000		
RZB / RCF	³⁾	2415	2415	2451	2451	2451	2325	2325	2325	2451		
Radius / radius	mm	135	135	137	137	137	130	130	130	137		
9 (97%)	sec						22					
9	sec						25					
Probenerwärmung/Sample temp. rise	K ¹⁾						10					

1) Probenerwärmung bei maximaler Drehzahl und 1 Stunde Laufzeit

4) nicht mit Stopfen zentrifugierbar, Skal. 10µl-300µl, 15ml, 30ml

5) Nach DIN EN 61010, Teil 2 – 020. Die Hinweise für Bio-Sicherheitssysteme in den Kapiteln "Sicherheitshinweise" und "Pflege und Wartung" beachten





3) Angaben des Röhrchenherstellers beachten.



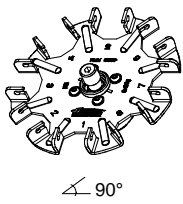

1) Sample temp. rise during maximum speed and 1 hour running time

4) can not be centrifugated when plug is attached, Scal. 10µl-300µl, 15ml, 30ml

5) in conformity with DIN EN 61010, part 2 – 020. Observe the notes for bio safety systems in chapters "Notes on safety" and "Maintenance and servicing".

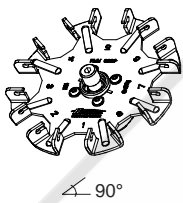





3) Observe the tube manufacturer's instructions.



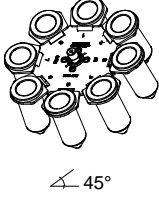

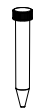

1611	1131-A						1132-A				
Ausschwingrotor 8-fach / Swing out rotor 8-times  ∠ 90°	---										
											
	---	---	---	---	---	---	---	---	---	---	
Kapazität / capacity	ml	5	6	2,7 - 3,0	2,6 - 2,9	1,6 - 5,0	10	4 - 5,5	4 - 7		
Maße / dimensions	∅ x L	mm	12 x 75	13 x 75	12 x 82	11 x 66	13 x 65	13 x 75	17 x 70	15 x 75	16 x 75
Anzahl p. Rotor / number p. rotor		8									
Drehzahl / speed	RPM	4000									
RZB / RCF	³⁾	1914									
Radius / radius	mm	107									
 9 (97%)	sec	22									
 9	sec	25									
Probenerwärmung/Sample temp. rise	K ¹⁾	6									

1611	1643					1644				
Ausschwingrotor 8-fach / Swing out rotor 8-times  ∠ 90°	---									
										
	---	---	---	---	---	---	---	---	---	---
Kapazität / capacity	ml	7	4 - 7	10	4,5 - 5	15	7,5 - 8,2	8,5 - 10	---	
Maße / dimensions	∅ x L	mm	12 x 100	13 x 100	13 x 100	11 x 92	17 x 100	15 x 92	16 x 100	---
Anzahl p. Rotor / number p. rotor		8								
Drehzahl / speed	RPM	4000								
RZB / RCF	³⁾	2415								
Radius / radius	mm	135								
 9 (97%)	sec	22								
 9	sec	25								
Probenerwärmung/Sample temp. rise	K ¹⁾	6								

- 1) Probenerwärmung bei maximaler Drehzahl und 1 Stunde Laufzeit
- 3) Angaben des Röhrenherstellers beachten.

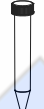









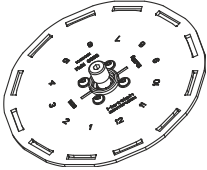

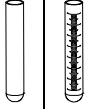

- 1) Sample temp. rise during maximum speed and 1 hour running time
- 3) Observe the tube manufacturer's instructions.







1617		---							
Ausschwingrotor 8-fach / Swing out rotor 8-times  45°		---	---	---	---	---	---	---	---
		1462-A	---	---	---	---	---	---	---
			---	---	---	---	---	---	---
		 	---	---	---	---	---	---	---
Kapazität / capacity	ml	15	50	---	---	---	---	---	
Maße / dimensions	Ø x L	mm	17 x 120	29 x 115	---	---	---	---	
Anzahl p. Rotor / number p. rotor		8	8	---	---	---	---	---	
Drehzahl / speed	RPM	4000	4000	---	---	---	---	---	
RZB / RCF	³⁾	2469	2469	---	---	---	---	---	
Radius / radius	mm	138		---	---	---	---	---	
 9 (97%)	sec	22		---	---	---	---	---	
 9	sec	25		---	---	---	---	---	
Probenerwärmung/Sample temp. rise	K ¹⁾	11		---	---	---	---	---	

1619		---							
Ausschwingrotor 6-fach / Swing out rotor 6-times  90°		---	---	---	---	---	---	---	
		1462-A	---	---	---	---	---	---	
			---	---	---	---	---	---	---
		 	---	---	---	---	---	---	---
Kapazität / capacity	ml	15	50	---	---	---	---	---	
Maße / dimensions	Ø x L	mm	17 x 120	29 x 115	---	---	---	---	
Anzahl p. Rotor / number p. rotor		6	6	---	---	---	---	---	
Drehzahl / speed	RPM	4000	4000	---	---	---	---	---	
RZB / RCF	³⁾	2701	2701	---	---	---	---	---	
Radius / radius	mm	151	151	---	---	---	---	---	
 9 (97%)	sec			22					
 9	sec			25					
Temperatur / temperature	°C ¹⁾			-					
Probenerwärmung/Sample temp. rise	K ²⁾			10					

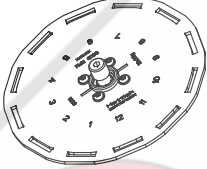
- 1) Tiefste erreichbare Temperatur bei maximaler Drehzahl, 1 h Laufzeit und 20°C Raumtemperatur (nur bei Kühlzentrifuge)
- 2) Probenerwärmung bei maximaler Drehzahl und 1 Stunde Laufzeit (nur bei Zentrifuge ohne Kühlung)
- 3) Angaben des Röhrchenherstellers beachten.









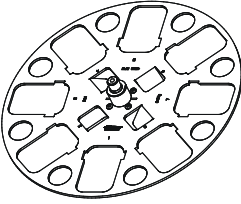

- 1) Lowest possible temperature during maximum speed, 1 h running time and 20°C ambient temperature (only with cooling centrifuges)
- 2) Sample temp. rise during maximum speed and 1 hour running time (only with centrifuges without cooling)
- 3) Observe the tube manufacturer's instructions.

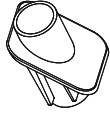



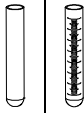
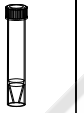

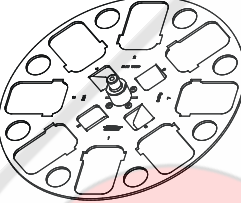

1628	1621			1122			1127-A	
Ausschwingrotor 12-fach / Swing out rotor 12-times  ↙ 80° mit / with 1621 ↙ 60° mit / with 1122 ↙ 55° mit / with 1127-A								
	---	---	---	---	---	---	---	---
	---	---	---	---	---	---	---	---
								
Kapazität / capacity ml	15	7,5 – 8,2	8,5 - 10	10	4 – 5,5	4 – 7	5	1,6 – 5,0
Maße / dimensions Ø x L mm	17 x 100	15 x 92	16 x 100	17 x 70	15 x 75	16 x 75	12/13 x 75	13 x 75
Anzahl p. Rotor / number p. rotor	12	12	12	12	12	12	12	12
Drehzahl / speed RPM	4000							
RZB / RCF ³⁾	2683	2683	2683	2254	2254	2254	2236	2236
Radius / radius mm	150	150	150	126	126	126	125	125
 9 (97%)	22							
 9	25							
Probenerwärmung/Sample temp. rise K ¹⁾	12							

1628	1127-A		---	---
Ausschwingrotor 12-fach / Swing out rotor 12-times  ↙ 55°			---	---
	---	---	---	---
	---	---	---	---
			---	---
Kapazität / capacity ml	2,7 – 3	2,6 – 2,9	---	---
Maße / dimensions Ø x L mm	11 x 66	13 x 65	---	---
Anzahl p. Rotor / number p. rotor	12		---	---
Drehzahl / speed RPM	4000		---	---
RZB / RCF ³⁾	2236		---	---
Radius / radius mm	125		---	---
 9 (97%)	16		---	---
 9	16		---	---
Probenerwärmung/Sample temp. rise K ²⁾	14		---	---

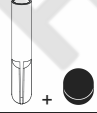
- 1) Probenerwärmung bei maximaler Drehzahl und 1 Stunde Laufzeit (nur bei Zentrifuge ohne Kühlung)
 3) Angaben des Röhrchenherstellers beachten.

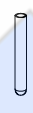
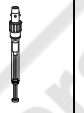
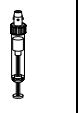
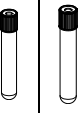









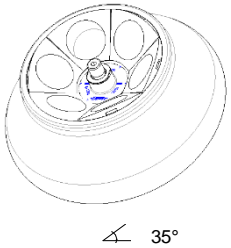
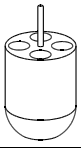

- 1) Sample temp. rise during maximum speed and 1 hour running time (only with centrifuges without cooling)
 3) Observe the tube manufacturer's instructions.





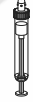





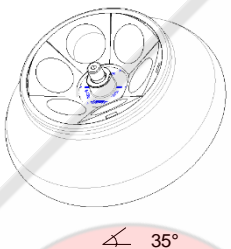





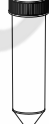

1418		1467				1468			
Winkelrotor 8-fach / Angle rotor 8-times  $\angle 45^\circ$									
		---				---			
		0716		E2109		---		---	
						---			
									
Kapazität / capacity	ml	15	9 - 10	12	15	50	50	50	---
Maße / dimensions $\varnothing \times L$	mm	17 x 100	16 x 92	17 x 100	17 x 120	29 x 107	29 x 115	29 x 115	---
Anzahl p. Rotor / number p. rotor		32	32	32	32	8	8	8	---
Drehzahl / speed	RPM	4000	4000	4000	4000	4000	4000	4000	---
RZB / RCF	³⁾	4000	4000	4000	2594	2486	2486	2486	---
Radius / radius	mm	2540	2540	2594	145	139	139	139	---
 9 (97%)	sec					36			
 9	sec					43			
Temperatur / temperature	$^\circ\text{C}$ ¹⁾					-			
Probenerwärmung/Sample temp. rise	K ²⁾					16			

1418		1467									
Winkelrotor 8-fach / Angle rotor 8-times  $\angle 45^\circ$											
		1054-A + 0701		1054-A				0716			
											
											
Kapazität / capacity	ml	4	5	1,1 - 1,4	2,7 - 3	2,6 - 2,9	1,6 - 5	4 - 7	8,5 - 10	12	
Maße / dimensions $\varnothing \times L$	mm	12 x 60	12 x 75 13 x 75	8 x 66	11 x 66	13 x 65	13 x 75	13 x 100	16 x 100	17 x 102	
Anzahl p. Rotor / number p. rotor		32	32	32	32	32	32	32	32	32	
Drehzahl / speed	RPM	4000	4000	4000	4000	4000	4000	4000	4000	4000	
RZB / RCF	³⁾	2129	2182	2182	2182	2182	2182	2540	2540	2540	
Radius / radius	mm	119	122	122	122	122	122	142	142	142	
 (97%)	sec					36					
 1	sec					43					
Probenerwärmung/Sample temp. rise	K ¹⁾					16					

- 1) Probenerwärmung bei maximaler Drehzahl und 1 Stunde Laufzeit (nur bei Zentrifuge ohne Kühlung)
3) Angaben des Röhrchenherstellers beachten.











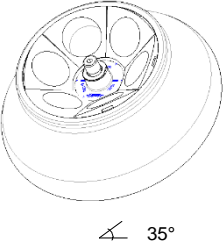

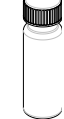

- 1) Sample temp. rise during maximum speed and 1 hour running time (only with centrifuges without cooling)
3) Observe the tube manufacturer's instructions.

1620A		1449			---			1451		
Winkelrotor 6-fach / Angle rotor 6-times  35°										
										
Kapazität / capacity	ml	1,5	2,0	0,5	3	15	7,5 – 8,2	9 - 10	10	8,5 - 10
Maße / dimensions	Ø x L mm	11 x 38	10,7 x 46	10 x 60	17 x 100	15 x 92	16 x 92	15 x 102	16 x 100	
Anzahl p. Rotor / number p. rotor		24			6					
Drehzahl / speed	RPM				6000					
RZB / RCF	³⁾	4105			3904					
Radius / radius	mm	102			97					
 9 (97%)	sec				19					
 9	sec				22					
Temperatur / temperature	°C ¹⁾									
Probenerwärmung/Sample temp. rise	K ²⁾				5					

1620A		---			---			---								
Winkelrotor 6-fach / Angle rotor 6-times  35°																
																
Kapazität / capacity	ml	85	15	50	30	50	85	50	50							
Maße / dimensions	Ø x L mm	38 x 106	17 x 120	29 x 115	26 x 95	29 x 107	38 x 101	35 x 105	34 x 100							
Anzahl p. Rotor / number p. rotor		6	6	3	6	6	6	6	6							
Drehzahl / speed	RPM				6000											
RZB / RCF	³⁾	4226	3985	3824	3824	4226	4146									
Radius / radius	mm	105	99	95	95	105	103									
 9 (97%)	sec				19											
 9	sec				22											
Probenerwärmung/Sample temp. rise	K ¹⁾				5											











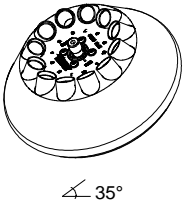

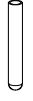



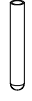

- 1) Probenerwärmung bei maximaler Drehzahl und 1 Stunde Laufzeit (nur bei Zentrifuge ohne Kühlung)
 3) Angaben des Röhrchenherstellers beachten.

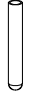





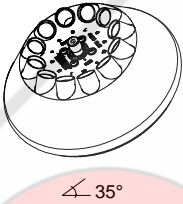

- 1) Sample temp. rise during maximum speed and 1 hour running time (only with centrifuges without cooling)
 3) Observe the tube manufacturer's instructions.

1620A		---			---			
Winkelrotor 6-fach / Angle rotor 6-times  \sphericalangle 35°	1448	1403	1646	SK 63.98				
				Set  +  + E1961 (6x)				
								
Kapazität / capacity	ml	10	4	50	5	6	1,6 - 5	2,6 - 3,4
Maße / dimensions \varnothing x L	mm	16 x 80	12 x 40	29 x 115	12/13 x 75	12 x 82	13 x 75	13 x 65
Anzahl p. Rotor / number p. rotor		12	24	6		12	12	12
Drehzahl / speed	RPM	6000						
RZB / RCF	³⁾	3904	4025	3985	3783	3783	3783	3783
Radius / radius	mm	97	100	99	94	94	94	94
 9 (97%)	sec	19						
 9	sec	22						
Probenerwärmung/Sample temp. rise	K ¹⁾	5						

- 1) Probenerwärmung bei maximaler Drehzahl und 1 Stunde Laufzeit
- 3) Angaben des Röhrchenherstellers beachten.











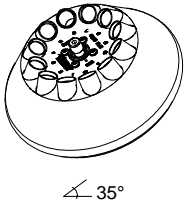

- 1) Sample temp. rise during maximum speed and 1 hour running time
- 3) Observe the tube manufacturer's instructions.

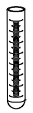
1613		---								
Winkelrotor 12-fach / Angle rotor 12-times  $\sphericalangle 35^\circ$		1054-A					1054-A /0701	---	---	
										
										
Kapazität / capacity	ml	5	1,6 – 5,0	6	2,6 – 2,9	2,7 – 3	1,1 – 1,4	4	8,5 - 10	8
Maße / dimensions \varnothing x L	mm	12/13 x 75	13 x 75	12 x 82	13 x 65	11 x 66	8 x 66	12 x 60	16 x 100	16 x 125
Anzahl p. Rotor / number p. rotor		12	12	12	12		12	12	12	6
Drehzahl / speed	RPM	6000	6000	6000	6000	6000	6000	6000	6000	6000
RZB / RCF	³⁾	3300	3300	3300	3300	3300	3300	3260	4146	4146
Radius / radius	mm	82	82	82	82	82	82	81	103	103
 9 (97%)	sec	13								
 9	sec	15								
Temperatur / temperature	$^\circ\text{C}^{1)}$									
Probenerwärmung/Sample temp. rise	K ²⁾	5								

1613		---							
Winkelrotor 12-fach / Angle rotor 12-times  $\sphericalangle 35^\circ$									
									
Kapazität / capacity	ml	4,5 - 5	4,9	7,5 – 8,2	9 – 10	---	---	---	---
Maße / dimensions \varnothing x L	mm	11 x 92	13 x 90	15 x 92	16 x 92	---	---	---	---
Anzahl p. Rotor / number p. rotor		12	12	12	12	12	---	---	---
Drehzahl / speed	RPM	6000	6000	6000	6000	---	---	---	---
RZB / RCF	³⁾	4146	4146	4146	4146	---	---	---	---
Radius / radius	mm	103	103	103	103	---	---	---	---
 9 (97%)	sec	13							
 9	sec	15							
Temperatur / temperature	$^\circ\text{C}^{1)}$								
Probenerwärmung/Sample temp. rise	K ²⁾	5							











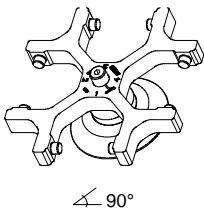
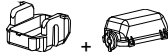

- 1) Probenerwärmung bei maximaler Drehzahl und 1 Stunde Laufzeit
- 3) Angaben des Röhrchenherstellers beachten.









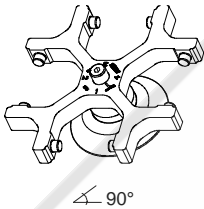

- 1) Sample temp. rise during maximum speed and 1 hour running time
- 3) Observe the tube manufacturer's instructions.

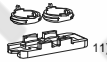
1613		---							
Winkelrotor 12-fach / Angle rotor 12-times  $\sphericalangle 35^\circ$	---	---	---	---	---	6305	1063-6		
					---				
	---	---	---	---	---	---	---	---	---
									
Kapazität / capacity	ml	4 – 7	15	15	---	4	0,5	1,5	2,0
Maße / dimensions	Ø x L mm	13 x 100	17 x 100	17 x 120	---	10 x 88	10,7 x 46	11 x 38	11 x 38
Anzahl p. Rotor / number p. rotor		12	12	6	---	6	12	12	12
Drehzahl / speed	RPM	6000	6000	6000	---	6000	6000	6000	6000
RZB / RCF	³⁾	4146	4146	4146	---	3502	2777	2737	2737
Radius / radius	mm	103	103	103	---	87	69	68	68
 9 (97%)	sec	13							
 9	sec	15							
Temperatur / temperature	°C ¹⁾								
Probenerwärmung/Sample temp. rise	K ²⁾	5							

- 1) Probenerwärmung bei maximaler Drehzahl und 1 Stunde Laufzeit
- 3) Angaben des Röhrchenherstellers beachten.

- 1) Sample temp. rise during maximum speed and 1 hour running time
- 3) Observe the tube manufacturer's instructions.

Ausschwingrotor 4-fach / Swing out rotor 4-times  $\angle 90^\circ$	 ---								
	1662 						1670  ¹¹⁾		
	1663	1664	1665	1666	1667	1668	1663	1664	
									
Kapazität / capacity	ml	1	2	4	8	3 x 2	4 x 1	1	2
Maße / dimensions \varnothing / A	mm ²	6,2 / 30	8,7 / 60	12,4 / 120	17,5 / 240	8,7 / 60	6,2 / 30	6,2 / 30	8,7 / 60
Anzahl p. Rotor / number p. rotor		4	4	4	4	4	4	4	4
Filterkarten / filter cards		1675	1675	1675	1676	1677	1678	1692	1692
Drehzahl / speed	RPM	4000							
RZB / RCF	³⁾	1646							
Radius / radius	mm	92							
 9 (97%)	sec	22							
 9	sec	25							
Probenerwärmung/Sample temp. rise	K ¹⁾	10							

Ausschwingrotor 4-fach / Swing out rotor 4-times  $\angle 90^\circ$	1660 + 1661 				---	1680 			
	1670  ¹¹⁾				---	1662 			
	1665	1666	1667	1668	---	1671	1672	1673	
					---				
Kapazität / capacity	ml	4	8	3 x 2	4 x 1	---	[1] 0,5	[1] 0,5	[1] 0,5
Maße / dimensions \varnothing / A	mm ²	12,4 / 120	17,5 / 240	8,7 / 60	6,2 / 30	---	6,2 / 30	8,7 / 60	12,4 / 120
Anzahl p. Rotor / number p. rotor		4	4	4	4	---	4	4	4
Filterkarten / filter cards		1692	1691	1694	1693	---	[1] 1696	[1] 1697	[1] 1698
Drehzahl / speed	RPM	4000	4000	4000	4000	---	4000	4000	4000
RZB / RCF	³⁾	1646	1646	1646	1646	---	1467	1467	1467
Radius / radius	mm	92	92	92	92	---	82	82	82
 9 (97%)	sec	22							
 9	sec	25							
Probenerwärmung/Sample temp. rise	K ¹⁾	10							

1) Probenerwärmung bei maximaler Drehzahl und 1 Stunde Laufzeit

6) Objektträger nur belastbar bis RZB 1100

3) Angaben des Röhrchenherstellers beachten.

11) Objektträger nur belastbar bis RZB 1100

[1] Einschritt-Methode











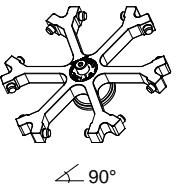

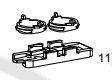
1) Sample temp. rise during maximum speed and 1 hour running time









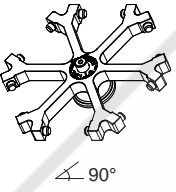

6) Object slide will not stand RCF values exceeding 1100

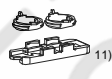
3) Observe the tube manufacturer's instructions.

11) Object slide will not stand RCF values exceeding 1100







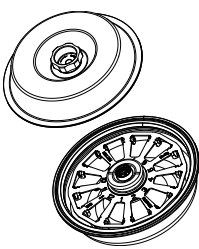

[1] One-step method

1626		1660 + 1661							
Ausschwingrotor 6-fach / Swing out rotor 6-times  ↙ 90°		 ---							
		1662				1670			
		 ---				 ¹⁾			
		1663	1664	1665	1666	1667	1668	1663	1664
									
Kapazität / capacity	ml	1	2	4	8	3 x 2	4 x 1	1	2
Maße / dimensions Ø / A	mm ²	6,2 / 30	8,7 / 60	12,4 / 120	17,5 / 240	8,7 / 60	6,2 / 30	6,2 / 30	8,7 / 60
Anzahl p. Rotor / number p. rotor		6	6	6	6	6	6	6	6
Filterkarten / filter cards		1675	1675	1675	1676	1677	1678	1692	1692
Drehzahl / speed	RPM	4000							
RZB / RCF	³⁾	2039							
Radius / radius	mm	114							
 9 (97%)	sec	22							
 9	sec	25							
Temperatur / temperature	°C ¹⁾								
Probenerwärmung/Sample temp. rise	K ²⁾	8							

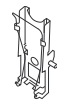
1626		1660 + 1661				---	1680		
Ausschwingrotor 6-fach / Swing out rotor 6-times  ↙ 90°		 ---				---			
		1670				---	1662		
		 ¹⁾				---			
		1665	1666	1667	1668	---	1671	1672	1673
						---			
Kapazität / capacity	ml	4	8	3 x 2	---		[1] 0,5	[1] 0,5	[1] 0,5
Maße / dimensions Ø / A	mm ²	12,4 / 120	17,5 / 240	8,7 / 60	---		6,2 / 30	8,7 / 60	12,4 / 120
Anzahl p. Rotor / number p. rotor		6	6	6	6	---	6	6	6
Filterkarten / filter cards		1692	1691	1694	1693	---	[1] 1696	[1] 1697	[1] 1698
Drehzahl / speed	RPM	4000	4000	4000	4000	---	4000	4000	4000
RZB / RCF	³⁾	2039	2039	2039	2039	---	1842	1842	1842
Radius / radius	mm	114	114	114	114	---	103	103	103
 9 (97%)	sec	22							
 0	sec	25							
Probenerwärmung/Sample temp. rise	K ¹⁾	8							

- 1) Probenerwärmung bei maximaler Drehzahl und 1 Stunde Laufzeit
- 3) Angaben des Röhrchenherstellers beachten.
- 6) Objektträger nur belastbar bis RZB 1100
- 11) Objektträger nur belastbar bis RZB 1100
- [1] Einschritt-Methode

- 1) Sample temp. rise during maximum speed and 1 hour running time
- 3) Observe the tube manufacturer's instructions.
- 6) Object slide will not stand RCF values exceeding 1100
- 11) Object slide will not stand RCF values exceeding 1100
- [1] One-step method

1515-A		1524						
Rotor 12-fach  								
		1531 / 1534 ¹²⁾	1532 ¹²⁾	1536 ¹²⁾	1538 ¹²⁾	---	---	---
		---	---	1537 ¹²⁾	1539 ¹²⁾	---	---	---
						---	---	---
Kapazität / capacity	ml	0,5	0,2	6 ¹³⁾	0,5	---	---	---
Maße / dimensions Ø / A	mm ²	6 / 28,3	6 / 28,3	-	6 / 28,3	---	---	---
Maße (L x B) / dimensions (L x W)	mm	---	---	13,4 x 22	---	---	---	---
Anzahl p. Rotor / number p. rotor		12						
Drehzahl / speed	RPM	2000						
RZB / RCF	³⁾	438						
Radius / radius	mm	98						
 9 (97%)	sec	19						
Probenerwärmung/sample temp. rise	K ¹⁾	3						

1) Probenerwärmung bei maximaler Drehzahl und 1 Stunde Laufzeit (nur bei Zentrifuge ohne Kühlung)

1) Sample temp. rise during maximum speed and 1 hour running time (only with centrifuges without cooling)

3) Angaben des Röhrchenherstellers beachten.

3) Observe the tube manufacturer's instructions.

12)	Bestell-Nr. / Cat. No.	Menge / Quantity	Bestell-Nr. / Cat. No.	Menge / Quantity
	1531, 1532	50 St. / 50 pcs.	1536, 1538	12 St. / 12 pcs.
	1534	500 St. / 500 pcs.	1539	200 St. / 200 pcs.
	1537	100 St. / 100 pcs.		

13) Dies ist das maximale Fassungsvermögen, die empfohlene Füllmenge der Kammern beträgt 4 ml.

13) This is the maximum capacity. The recommended quantity to be used per chamber is 4 ml.



LABORATORY EQUIPMENT MAINTENANCE, REPAIR, CALIBRATION AND SALES

Established in 1987, Henderson Biomedical is the UK's leading laboratory equipment sales and service provider. Our knowledgeable team can provide you with excellent sales advice on a range of different types of laboratory equipment including centrifuges, refrigerators, freezers and heat sealers.

Henderson Biomedical is also able to provide you with first class after-sales service and calibration of your laboratory equipment. We are an **ISO 17025 (UKAS) accredited calibration test laboratory** and our team of Field Service Engineers cover the whole of the United Kingdom.

Please contact us for more information on the types of equipment we supply and the different after-sales services we can offer.

Henderson Biomedical

Unit 3, Swan Close
Croydon CR0 2DZ
United Kingdom

Tel: 020 8663 4610

**For sales enquiries: sales@henderson-biomedical.co.uk
For all other enquiries: info@henderson-biomedical.co.uk
www.henderson-biomedical.co.uk**

