



# Sigma 3-16L Sigma 3-16L IVD

from serial no. 146284



## Operating Manual

Please retain for later use!





© Copyright by  
Sigma Laborzentrifugen GmbH  
An der Unteren Söse 50  
37520 Osterode am Harz  
Germany

Tel.: +49 (0) 5522 / 5007-0  
Fax: +49 (0) 5522 / 5007-12  
Web: [www.sigma-zentrifugen.de](http://www.sigma-zentrifugen.de)  
E-mail: [info@sigma-zentrifugen.de](mailto:info@sigma-zentrifugen.de)



<b>1</b>	<b>General information</b>	<b>9</b>
1.1	Importance of the operating manual	9
1.2	Intended use	9
1.3	Warranty and liability	9
1.4	Copyright	10
1.5	Standards and regulations	10
1.6	Scope of supply	10
<b>2</b>	<b>Layout and mode of operation</b>	<b>11</b>
2.1	Layout of the centrifuge	11
2.1.1	Functional and operating elements	11
2.1.2	Name plate	12
2.2	Mode of operation	13
2.2.1	Centrifugation principle	13
2.2.2	Area of application	13
2.2.2.1	Speed, radius, and relative centrifugal force	14
2.2.2.2	Density	14
<b>3</b>	<b>Safety</b>	<b>15</b>
3.1	Marking of the unit	15
3.2	Explanation of the symbols and notes	16
3.3	Responsibility of the operator	17
3.4	Operating personnel	17
3.5	Informal safety instructions	17
3.6	Safety instructions	18
3.6.1	Electrical safety	18
3.6.2	Mechanical safety	18
3.6.3	Fire prevention	19
3.6.4	Chemical and biological safety	19
3.6.5	Safety instructions for centrifugation	20
3.6.6	Resistance of plastics	20
3.6.7	Safety of rotors and accessories	21
3.6.7.1	Service life	21
3.7	Safety devices	22
3.7.1	Lid lock device	22
3.7.2	Standstill monitoring system	22
3.7.3	System check	22
3.7.4	Earth conductor check	22
3.7.5	Imbalance monitoring system	22
3.7.6	Rotor monitoring system	22
3.8	Measures in the event of hazards and accidents	23
3.9	Remaining hazards	23

## Table of contents

<b>4</b>	<b>Storage and transport</b>	<b>24</b>
4.1	Dimensions and weight	24
4.2	Storage conditions	24
4.3	Notes on transport	24
4.4	Packaging	25
4.5	Transport safety device	25
<b>5</b>	<b>Set-up and connection</b>	<b>26</b>
5.1	Installation site	26
5.2	Power supply	26
5.2.1	Type of connection	26
5.2.2	Customer-provided fuses	27
<b>6</b>	<b>Using the centrifuge</b>	<b>28</b>
6.1	Initial start-up	28
6.2	Switching the centrifuge on	28
6.2.1	Opening and closing the lid	28
6.2.2	Installation of rotors and accessories	29
6.2.2.1	Installation of a standard rotor	29
6.2.2.2	Installation of a standard angle rotor with a hermetic lid	29
6.2.2.3	Installing a rotor with the g-lock® system	30
6.2.2.4	Installation of accessories	31
6.2.2.5	Adapters	32
6.2.2.6	Vessels	32
6.3	Control system "Spincontrol L"	33
6.3.1	User interface	33
6.3.2	Manual mode	34
6.3.2.1	Starting a centrifugation run	34
6.3.2.2	Interrupting a centrifugation run	34
6.3.2.3	Interrupting a deceleration process	34
6.3.2.4	Selection, display, and modification of data	34
6.3.2.5	Speed / relative centrifugal force (RCF)	35
6.3.2.6	Runtime	35
6.3.2.7	Rotor selection	37
6.3.2.8	Acceleration and deceleration curves	38
6.3.2.9	Automatic lid opening function ("AutoOpen")	39
6.3.2.10	Sound signal ("Buzzer")	39
6.3.2.11	Program lock ("ProgLock")	40
6.3.2.12	Cycle display ("Cycles")	40
6.3.2.13	Input lock	41
6.3.3	Program mode	42
6.3.3.1	Saving a program	42
6.3.3.2	Loading a program	43
6.4	Switching the centrifuge off	43

**Table of contents**

<b>7</b>	<b>Malfunctions and error correction</b> .....	<b>44</b>
7.1	General malfunctions .....	44
7.1.1	Emergency lid release .....	45
7.2	Table of error codes.....	46
7.3	Service contact .....	47
<b>8</b>	<b>Maintenance and service</b> .....	<b>48</b>
8.1	Maintenance .....	48
8.1.1	Centrifuge .....	48
8.1.2	Accessories .....	49
8.1.2.1	Plastic accessories .....	49
8.1.3	Rotors, buckets and carriers .....	50
8.1.4	Load bearing bolts .....	51
8.1.5	Glass breakage .....	52
8.2	Sterilisation and disinfection of the rotor chamber and accessories .....	52
8.2.1	Autoclaving .....	53
8.3	Service .....	54
8.4	Return of defective centrifuges or parts .....	55
<b>9</b>	<b>Disposal</b> .....	<b>57</b>
9.1	Disposal of the centrifuge .....	57
9.2	Disposal of the packaging.....	57
<b>10</b>	<b>Technical data</b> .....	<b>58</b>
10.1	Ambient conditions .....	59
10.2	Technical documentation .....	59
<b>11</b>	<b>Appendix</b> .....	<b>60</b>
11.1	Range of accessories .....	60
11.1.1	Rotor radii.....	60
11.2	Speed-gravitational-field-diagram .....	61
11.3	Acceleration and deceleration curves .....	62
11.4	Table of the service life of rotors and accessories.....	63
11.5	Resistance data.....	64
11.6	EC declaration of conformity.....	69
11.7	Declaration of conformity – China RoHS 2.....	73
<b>12</b>	<b>Index</b> .....	<b>75</b>

**Table of contents**

---





## 1 General information

### 1.1 Importance of the operating manual

A fundamental requirement for the safe and trouble-free operation of the centrifuge is to be familiar with the fundamental safety instructions and all possible hazards.

The operating manual includes important information concerning the safe operation of the centrifuge.

This operating manual and, in particular, the notes on safety and hazards must be observed by all persons operating the centrifuge.

In addition, the local rules and regulations for the prevention of accidents must be complied with.

### 1.2 Intended use

The laboratory centrifuge is suitable for the separation of constituents of different densities in mixtures with a maximum density of 1.2 g/cm<sup>3</sup>.

The laboratory centrifuge that is marked with IVD is intended for human biological samples, including donated blood and tissue, in conjunction with diagnostic in-vitro applications. This means that it is a medical product in accordance with the IVD directive 98/79/EC.

Only trained, specialised personnel are authorised to use the centrifuge in closed laboratories.

The intended use also includes:

- observation of all of the notes and instructions that are included in the operating manual and
- compliance with the inspection and maintenance instructions.

Sigma Laborzentrifugen GmbH cannot be held liable for any damage resulting from non-compliance.

### 1.3 Warranty and liability

The warranty and liability are subject to our "General Conditions" that were distributed to the operator upon the conclusion of the contract.

Warranty and liability claims are excluded if they are due to:

- improper use.
- non-compliance with the safety instructions and hazard warnings in the operating manual.
- improper installation, start-up, operation, or maintenance of the centrifuge.

## 1 General information

---

### 1.4 Copyright

The copyright concerning the operating manual remains with Sigma Laborzentrifugen GmbH.

The operating manual is solely intended for the operator and their personnel. It includes instructions and information that must not be

- duplicated,
- distributed, or
- communicated in any other way.

Non-compliance may be prosecuted under criminal law.

### 1.5 Standards and regulations

EC declaration of conformity  
(see chapter 11.6 - "EC declaration of conformity")

### 1.6 Scope of supply

**The centrifuge comprises:**

- 1 power cord with an IEC C13 connector
- 1 rotor wrench Part no. 930 100
- 1 tube (30 g) heavy-duty grease for load-bearing bolts Part no. 71 401

#### **Documentation**

Operating manual incl. EC declaration of conformity  
(see chapter 11.6 - "EC declaration of conformity")

#### **Accessories**

According to your order, our order confirmation, and your delivery note.

## 2 Layout and mode of operation

### 2.1 Layout of the centrifuge

#### 2.1.1 Functional and operating elements

- 1 Lid
- 2 User interface (see chapter 6.3.1 - "User interface")
- 3 Mains switch



Fig. 1: Total view of the centrifuge

- 4 Name plate (see chapter 2.1.2 - "Name plate")
- 5 Mains power input



Fig. 2: Rear view of the centrifuge

## 2 Layout and mode of operation

### 2.1.2 Name plate

- 1 Manufacturer
- 2 Power consumption
- 3 Max. speed
- 4 Max. kinetic energy
- 5 Serial number
- 6 Part number
- 7 Type
- 8 Nominal voltage
- 9 CE mark in compliance with the directive 2006/42/EC
- 10 Symbol for special disposal (see chapter 9 - "Disposal")
- 11 Consult operating manual
- 12 Date of manufacture
- 13 IVD mark (if applicable)
- 14 Max. permissible density

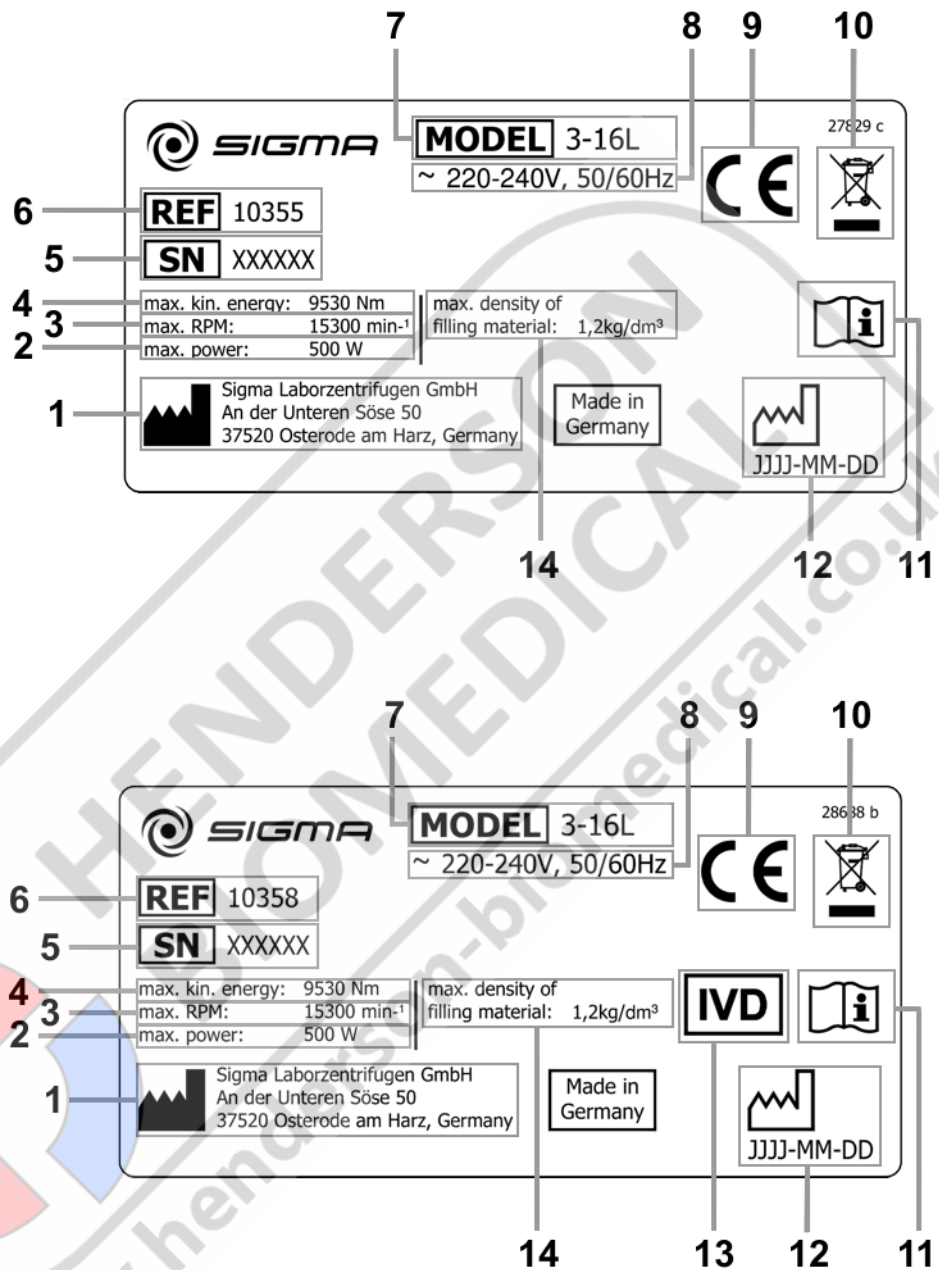

Fig. 3: Example of a name plate

## 2.2 Mode of operation

### 2.2.1 Centrifugation principle

Centrifugation is a process for the separation of heterogeneous mixtures of substances (suspensions, emulsions, or gas mixtures) into their components. The mixture of substances, which rotates on a circular path, is subject to centripetal acceleration that is several times greater than the gravitational acceleration.

Centrifuges use the mass inertia inside the rotor chamber for separating the substances. Due to their higher inertia, particles or media with a higher density travel outwards. In doing so, they displace the components with a lower density, which in turn travel towards the centre.

The centripetal acceleration of an object inside a centrifuge, as the effect of centripetal force, depends on the distance between the object and the axis of rotation as well as on the angular velocity. It increases linearly as a function of the distance with regard to the axis of rotation and quadratically as a function of the angular velocity. The bigger the radius in the rotor chamber is and the higher the speed is, the higher the centripetal acceleration is. However, the forces acting on the rotor also increase.

### 2.2.2 Area of application

Depending on the area of application of the centrifuge and also on the particle size, solids content, and volume throughput of the mixture of substances that is to be centrifuged, there are different types of centrifuges.

The areas of application go from household use as a salad spinner or honey separator up to specialised technical applications in the clinical, biological, or biochemical context:

- For numerous clinical examinations, cellular material must be separated from the liquid to be analysed. The normal separation process can be sped up considerably by using laboratory centrifuges.
- In the metal-working industry, centrifuges are used for separating oil from metal cuttings. Dairies use centrifuges in order to separate cow's milk into cream and low-fat milk.
- Particularly big centrifuges are used in the sugar industry for separating the syrup from the crystalline sugar.
- Ultracentrifuges are predominantly used in biology and biochemistry in order to isolate particles, e.g. viruses. They are specifically designed for high speeds up to 500,000 rpm. The rotor moves in a vacuum in order to avoid air friction.

## 2 Layout and mode of operation

---

### 2.2.2.1 Speed, radius, and relative centrifugal force

The acceleration  $g$ , which the samples are subject to, can be increased by increasing the radius in the rotor chamber and by increasing the speed. These three parameters are interdependent and linked with each other via the following formula:

$$\text{Relative centrifugal force RCF} = 11.18 \times 10^{-6} \times r \times n^2$$

$r$  = radius in cm

$n$  = speed in rpm

RCF without any dimension

If two values are entered, the third value is determined by way of the stated formula. If, afterwards, the speed or the radius is changed, the resulting relative centrifugal force will be recalculated automatically by the control unit. If the RCF is changed, the speed will be adapted while the specified radius is maintained.

The speed-gravitational-field-diagram provides an overview of the relationship between speed, radius, and RCF (see chapter 11.2 - "Speed-gravitational-field-diagram").

### 2.2.2.2 Density

The laboratory centrifuge is suitable for the separation of constituents of different densities in mixtures with a maximum density of  $1.2 \text{ g/cm}^3$ . All information concerning the speed of rotors and accessories refers to liquids with a density corresponding to this specification. If the density is above this value, the maximum permissible speed of the centrifuge must be reduced based on the following formula:















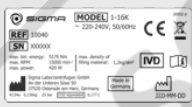



$$n = n_{\max} \times \sqrt{1.2 / \text{Rho}}$$

$\text{Rho}$  = density in  $\text{g/cm}^3$

### 3 Safety

#### 3.1 Marking of the unit

The following symbols are used for all types of centrifuges manufactured by Sigma:

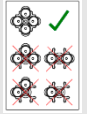
	Dangerous voltage		On (Power)
	Hot surface		Off (Power)
	Caution! Risk of bruising		Name plate (see chapter 2.1.2 - "Name plate")
	Protective earth (ground)		CE mark in compliance with the directive 2006/42/EC
	Earth (ground)		Do not dispose as part of domestic waste
	Unplug the mains plug		Do not dispose as part of domestic waste
	g-lock <sup>®</sup> system installed		GS mark (tested safety; only for Germany)
	Arrow indicating the direction of rotation		NRTL mark (only for the USA and Canada)
	4°C Guarantee		RCM mark (only for Australia)
	Centrifuge with heating system		Medical product in accordance with the IVD directive 98/79/EC (In-vitro diagnostica)
	Rotor loading information (see chapter 6.2.2.4 - "Installation of accessories")		

### 3 Safety



Safety indications on the centrifuge must be kept readable at all times. If necessary, they must be replaced.



Not all of the symbols/labels are used for this centrifuge type.

### 3.2 Explanation of the symbols and notes

In this operating manual, the following names and symbols to indicate hazards are used:



This symbol stands for a **direct** hazard to the life and health of persons.

Non-observance of these symbols **causes** serious health problems up to life-endangering injuries.



This symbol stands for a **direct** hazard to the life and health of persons due to electrical voltage.

Non-observance of these symbols **causes** serious health problems up to life-endangering injuries.



This symbol stands for a **potential** hazard to the life and health of persons.

Non-observance of these symbols **can** cause serious health problems up to life-endangering injuries.



This symbol indicates a potentially hazardous situation

Non-observance of these notes can cause minor injuries or damage to property.



This symbol indicates important information.



### 3.3 Responsibility of the operator

The operator undertakes to authorise only trained, specialised personnel to work on the centrifuge (see chapter 3.4 - "Operating personnel").

The areas of responsibility of the personnel concerning the operation, maintenance, and care of the unit must be clearly defined.

The safety-conscious work of the personnel in compliance with the operating manual and the relevant EC health and safety directives, and the national laws concerning health and safety and the prevention of accidents must be checked at regular intervals (e.g. every month).

Under the international rules for health and safety at work, the operator is obliged to:

- take measures in order to prevent danger to life or health during work.
- ensure that the centrifuges are used properly and entirely as intended (see chapter 1.2 - "Intended use").
- take protective measures against fire and explosion when working with hazardous substances.
- take measures for the safe opening of the centrifuges.

The operator must perform a risk assessment concerning potential accidents in connection with the centrifuge and take design-related countermeasures, if necessary.

The centrifuge has to be maintained regularly (see chapter 8 - "Maintenance and service").

Components that are not in a perfect state must be replaced immediately.

### 3.4 Operating personnel

Only trained, specialised personnel are authorised to operate the unit. The persons operating the unit must

- be familiar with the fundamental health, safety, and accident prevention regulations.
- have read and understood this operating manual, in particular the safety sections and warning notes, and confirmed this with their signature.

### 3.5 Informal safety instructions

- This operating manual is a part of the product.
- The operating manual must be kept at the location of use of the centrifuge. Ensure that it is accessible at all times.
- The operating manual must be handed over to any subsequent owner or operator of the centrifuge.
- Any changes, additions or updates received must be added to the operating manual.
- In addition to the operating manual, the general and local rules and regulations concerning the prevention of accidents and the protection of the environment must also be supplied.
- Safety and danger indications on the centrifuge must be kept readable at all times. If necessary, they must be replaced.

### 3 Safety

## 3.6 Safety instructions

### 3.6.1 Electrical safety

To reduce the risk of electrical shock, the centrifuge uses a three-wire electrical cord and plug to connect the equipment to earth-ground. To preserve this safety feature:



**DANGER**

- Ensure that the wall socket is properly wired and grounded.
- Check that the mains voltage agrees with the nominal voltage listed on the name plate.
- Do not place vessels containing liquid on the centrifuge lid or within the safety distance of 30 cm around the centrifuge. Spilled liquids may get into the centrifuge and damage electrical or mechanical components.
- Only qualified and specialised personnel are authorised to perform service tasks or repairs of the electrical system for which the housing needs to be removed.
- Inspect the electrical equipment of the unit regularly. Defects such as loose or burnt cables must be eliminated immediately.
- Following the completion of any type of repair or service, the qualified and specialised personnel must perform final inspection and testing in compliance with the relevant standards.

### 3.6.2 Mechanical safety

In order to ensure the safe operation of the centrifuge, observe the following:



**WARNING**

- Do not open the lid when the rotor is in motion!
- Do not reach into the rotor chamber when the rotor is in motion!
- Do not use the centrifuge if it was installed incorrectly.
- Do not use the centrifuge without panels.
- Do not use the centrifuge if the rotors and inserts show signs of corrosion or other defects.
- Only use the centrifuge with rotors and accessories that have been approved by the manufacturer. In case of doubt, contact the manufacturer (see chapter 7.3 - "Service contact").
- Do not hold your fingers between the lid and the housing when closing the lid. Risk of crushing!
- Defective lid relieving devices could cause the centrifuge lid to fall (contact the service department, if necessary). Risk of crushing!
- Do not hit or move the centrifuge during its operation.
- Do not lean against or rest on the centrifuge during its operation.
- Do not spin any substances that could damage the material of the rotors and buckets of the centrifuge in any way. Highly corrosive substances, for example, damage the material and affect the mechanical strength of the rotors and buckets.
- Stop the centrifuge immediately in the event of a malfunction. Eliminate the malfunction (see chapter 7 - "Malfunctions and error correction") or inform the service department of the manufacturer (see chapter 7.3 - "Service contact").

**WARNING**

- Ensure that all repairs are performed only by authorised and specialised personnel.
- Prior to any start-up, check the centrifuge, rotor, and accessories for signs of damage that can be discerned from the outside. Special attention must be paid to all of the rubber parts (e.g. motor cover, lid seal, and adapters) in terms of visible structural changes. Defective parts must be replaced immediately.
- Open the centrifuge when it is not in use so that moisture can evaporate.

### 3.6.3 Fire prevention

**DANGER**

- Do not spin explosive or inflammable substances.
- Do not use the centrifuge within hazardous locations.

### 3.6.4 Chemical and biological safety

If pathogenic, toxic, or radioactive samples are intended to be used in the centrifuge, it is in the responsibility of the user to ensure that all necessary safety regulations, guidelines, precautions, and practices are adhered to accordingly.

**DANGER**

- Infectious, toxic, pathogenic, and radioactive substances may only be used in special, certified containment systems with a bio-seal in order to prevent the material from being released.
- Take suitable precautions for your own safety if there is a risk of toxic, radioactive, or pathogenic contamination
- Materials that chemically react with each other with a high level of energy are prohibited.

**WARNING**

- Keep informed about local measures to avoid harmful emissions (depending on the substances to be centrifuged).
- Protective clothing is not required for the operation of the centrifuge. The materials to be centrifuged may, however, require special safety measures (e.g. centrifugation of infectious, toxic, radioactive, or pathogenic substances).

### 3 Safety

#### 3.6.5 Safety instructions for centrifugation

For safe operation, observe the following before starting the centrifuge:



**WARNING**

- Ensure that the centrifuge was set up properly (see chapter 5 - "Set-up and connection").
- Maintain a safety distance of at least 30 cm (12 inches) around the centrifuge.
- Do not store any dangerous goods in the centrifuge area.
- Do not stay in the safety area longer than what is absolutely necessary for the operation of the centrifuge.
- Only use the centrifuge with rotors and accessories that have been approved by the manufacturer. We explicitly warn against the use of equipment of poor quality. Breaking glass or bursting vessels can cause dangerous imbalances at high speeds
- Ensure that rotor and buckets are correctly fitted (see chapter 6.2.2.1 - "Installation of a standard rotor").
- Observe the instructions on the installation of accessories (see chapter 6.2.2.4 - "Installation of accessories").
- The rotor must be loaded in a rotationally symmetrical manner at equal weights.
- If liquids with a density  $> 1.2 \text{ g/cm}^3$  are used, reduce the speed (see chapter 2.2.2.2 - "Density").
- Do not use the centrifuge if the rotor is loaded asymmetrically.
- Do not use the centrifuge with tubes that are excessively long.

#### 3.6.6 Resistance of plastics

Chemical influences have a strong effect on the polymeric chains of plastics, and, therefore, on their physical properties. Plastic parts can be damaged if solvents, acids, or alkaline solutions are used.



**NOTE**

- Refer to the resistance data (see chapter 11.5 - "Resistance data")!

### 3.6.7 Safety of rotors and accessories

#### 3.6.7.1 Service life

The rotors and accessories have a limited service life.



**WARNING**

- Perform regular checks (at least once per month) for safety reasons!
- Pay special attention to changes, such as corrosion, cracks, material abrasion, etc.
- After 10 years, they must be inspected by the manufacturer.
- After 50,000 cycles, the rotor must be scrapped for reasons of safety.
- If other data concerning the service life are engraved on the rotor or bucket, these data shall apply accordingly. For example, a bucket with the engraving "max. cycles = 10,000" has a service life of 10,000 cycles, and a rotor with the engraving "Exp. date 01/27" must be scrapped in January 2027 at the latest (see figure).
- If a specification concerning the maximum number of cycles **and** a specification concerning the service life (i.e. a date) are provided, the specification that occurs first shall apply.

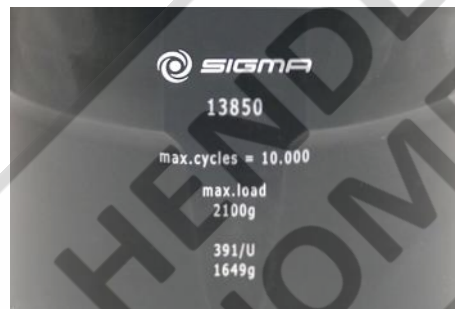

Fig. 4: Different service life – engraving on the bucket/rotor



**NOTE**

- Refer to the table of rotors and accessories with a different service life (see chapter 11.4 - " Table of the service life of rotors and accessories ")!

### 3 Safety

---

## 3.7 Safety devices

### 3.7.1 Lid lock device

The centrifuge can only be started when the lid is properly closed. The electrical lock must be locked. The lid can only be opened when the rotor has stopped. If the lid is opened by way of the emergency release system during operation, the centrifuge will immediately switch off and decelerate brakeless. If the lid is open, the drive is completely separated from the mains power supply, i.e. the centrifuge cannot be started (see chapter 7.1.1 - "Emergency lid release").

### 3.7.2 Standstill monitoring system

Opening of the centrifuge lid is only possible if the rotor is at a standstill. This standstill is checked by the microprocessor.

### 3.7.3 System check

An internal system check monitors the data transfer and sensor signals with regard to plausibility. The system continuously performs a self-check and identifies malfunctions. Error messages are displayed as "Error" followed by a code number (see chapter 7.2 - "Table of error codes").

### 3.7.4 Earth conductor check

An earth conductor check can be carried out by authorised and specialised personnel using a suitable measuring instrument. Please contact the Sigma service department (see chapter 7.3 - "Service contact").

### 3.7.5 Imbalance monitoring system

The indication "Imbalance" in the rotor field and, in some cases, also a sound signal indicate that the centrifuge is in the impermissible imbalance range. The drive will be switched off in the acceleration phase or during the run.

### 3.7.6 Rotor monitoring system

When a rotor number and, if applicable, a bucket number are selected, the computer will automatically check whether the entered speed or the entered gravitational field are permissible for the selected rotor.

### 3.8 Measures in the event of hazards and accidents



**DANGER**

- If an emergency arises, switch off the centrifuge immediately!
- If in doubt, call the emergency doctor!

### 3.9 Remaining hazards

The centrifuge was built in accordance with the state of the art and in compliance with the generally recognized safety rules. However, danger to life and limb of the operator, or of third parties, or impairments of the unit or other material assets cannot be completely excluded when the unit is being used.

- Use the unit only for the purpose that it was originally intended for (see chapter 1.2 - "Intended use").
- Use the unit only if it is in a perfect running state.
- Immediately eliminate any problems that can affect safety.

## 4 Storage and transport

# 4 Storage and transport

### 4.1 Dimensions and weight

	Sigma 3-16L, 3-16L IVD
Height:	355 mm
Height with open lid:	770 mm
Width:	460 mm
Depth:	600 mm
Weight:	48 kg

### 4.2 Storage conditions

The centrifuge can be stored in its original packaging for up to a year.

- Store the centrifuge only in dry rooms.
- The permissible storage temperature is between -20°C and +60°C.
- If you would like to store it for more than one year, or if you intend to ship it overseas, please contact the manufacturer.

### 4.3 Notes on transport

- Install the transport safety device (see chapter 4.5 - "Transport safety device")
- Always lift the centrifuge with a lifting device or with a sufficient number of people helping you.
- When lifting the centrifuge, always reach under the centrifuge from the side.



**CAUTION**

The centrifuge weighs approx. 48 kg!

- For transport use suitable packaging and, if at all possible, the original packaging (see chapter 4.4 - "Packaging").



## 4.4 Packaging

The centrifuge is packaged in a slip-lid box.

- Take off the lid.
- Remove the box containing the accessories and the packaging material.
- Remove the slip-lid box.
- Lift the centrifuge upwards with a lifting device or with a sufficient number of people to lift it safely. When lifting the centrifuge, always reach under the centrifuge from the side.



**CAUTION**

The centrifuge weighs approx. 48 kg!

- Retain the packaging for any possible future transport of the centrifuge.

## 4.5 Transport safety device

The transport safety device consists of a foamed plastic piece in the rotor chamber.



**CAUTION**

The transport safety device must be removed prior to start-up because the screws lock the motor bearings!

### Removal

- Open the lid by pressing the lid key. If the centrifuge is not connected to the power supply, use the emergency release of the lid (see chapter 7.1.1 - "Emergency lid release").
- Remove the foamed plastic piece (see figure, item 1) from the rotor chamber, by lifting it carefully on one side.



*Fig. 5: Removal of the transport safety device*

- Retain the transport safety device for the possibility of the return of the centrifuge.

## 5 Set-up and connection

# 5 Set-up and connection

## 5.1 Installation site

Operate the centrifuge only in closed and dry rooms.

All the energy supplied to the centrifuge is converted into heat and emitted to the ambient air.

- Ensure sufficient ventilation.
- Keep a safety distance of at least 30 cm around the centrifuge so that the vents in the centrifuge remain fully effective.
- Do not subject the centrifuge to thermal stress, e.g. by positioning it near heat generators.
- Avoid direct sunlight (UV radiation).
- The table must be stable and have a solid, even surface.
- Attention: During transport from cold to warmer places, condensational water will collect inside the centrifuge. It is important to allow sufficient time for drying (min. 24 h) before the centrifuge can be used again.

## 5.2 Power supply

### 5.2.1 Type of connection



**DANGER**

The operating voltage on the name plate must correspond to the local supply voltage!



**CAUTION**

The mains power plug is an isolating device which is why it must be accessible at all times.

Sigma centrifuges are units of protection class I. The centrifuges of this model series have a three-wire power cord with an IEC C13 connector.



**NOTE**

The removable power cord must not be longer than 3 m!  
The power cord must not be replaced with a power cord of inadequate rating!

The centrifuges are equipped with a mains power switch with an integrated thermal circuit breaker.

- Switch the unit off by actuating the mains power switch.
- If it has tripped, let the circuit breaker cool for approximately 2 minutes.
- Switch the unit on.

The centrifuge is now ready for operation.

**5.2.2 Customer-provided fuses**

Typically, the centrifuge must be protected with 16 Amp L or B fuses that are to be provided by the customer.



To ensure safe disconnection in the event of a fault, an AC/DC-sensitive RCD (residual current device) must be integrated in the wiring system of the building.



## 6 Using the centrifuge

# 6 Using the centrifuge

## 6.1 Initial start-up



**DANGER**

- Before the initial start-up, please ensure that your centrifuge is properly set up and installed (see chapter 5 - "Set-up and connection").

## 6.2 Switching the centrifuge on

- Press the mains power switch.  
The display then illuminates. The centrifuge is ready for operation.

### 6.2.1 Opening and closing the lid

The lid can be opened if the centrifuge is at a standstill and if the lid key is illuminated.

- Press the lid key in order to open the lid.  
The centrifuge cannot be started if the lid is opened.
- To close, press with both hands slightly on the lid until the lock is audibly locked.



**WARNING**

Do not place your fingers between the lid and the housing when closing the lid. Risk of crushing!

## 6.2.2 Installation of rotors and accessories

### 6.2.2.1 Installation of a standard rotor

- Open the centrifuge lid by pressing the lid key.
- Unscrew the rotor tie-down screw from the motor shaft (counter-clockwise).
- Lower the rotor with its central bore straight down onto the motor shaft.
- Tighten the rotor tie-down screw clockwise with the supplied rotor wrench with 7.5 Nm. In doing so, hold the rotor at its outer rim.

**WARNING**

Once a day or after 20 cycles, the rotor tie-down screw must be loosened by some turns, and the rotor must be lifted and fastened again. This ensures a proper connection between the rotor and the motor shaft.

**CAUTION**

When using rotors for microtiter plate formats:

Ensure that the plate holders are inserted together with the plates into the buckets.

**NOTE**

The lid screw serves for the fastening of the lid onto the rotor only, not for the fastening of the rotor onto the motor shaft.

- Follow the safety instructions and hazard warnings (see chapter 3 - "Safety")!

### 6.2.2.2 Installation of a standard angle rotor with a hermetic lid

- Open the centrifuge lid by pressing the lid key.
- Unscrew the rotor tie-down screw from the motor shaft (counter-clockwise).
- Screw the rotor lid onto the rotor and tighten it.
- Lower the rotor with the lid with its central bore straight down onto the motor shaft.
- Insert the rotor tie-down screw into the motor shaft. Tighten the rotor tie-down screw clockwise with the supplied rotor wrench with 7.5 Nm. In doing so, hold the rotor at its outer rim.
- Follow the safety instructions and hazard warnings (see chapter 3 - "Safety")!

**NOTE**

The rotor can also be used without a cover.

## 6 Using the centrifuge



The lid screw serves for the fastening of the lid onto the rotor only, not for the fastening of the rotor onto the motor shaft.

### Removal of a rotor

- Unscrew the rotor tie-down screw (counter-clockwise) and remove the rotor with the lid.
- Open the lid by turning it counter-clockwise and remove the lid.

- 1 Rotor tie down screw
- 2 Lid
- 3 Rotor

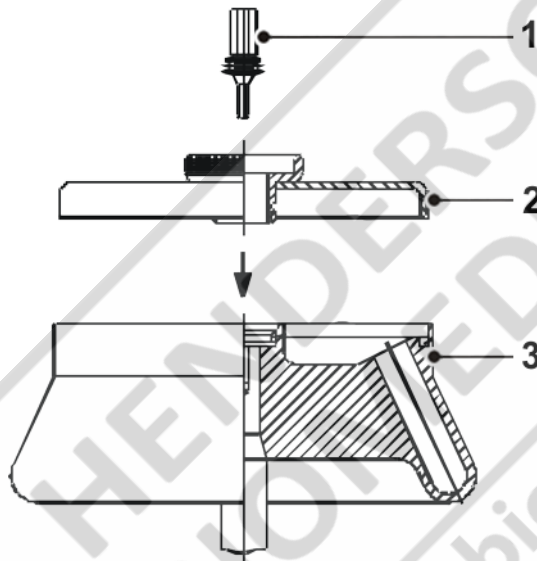

Fig. 6: Angle rotor with a hermetic lid

### 6.2.2.3 Installing a rotor with the g-lock® system

The handling of a rotor with the g-lock® system is described in a separate instruction manual.



See the separate instruction manual concerning the g-lock® rotor quick-lock system!

**6.2.2.4 Installation of accessories**

- Only use vessels that are suitable for the rotor.
- In the case of swing-out rotors, all of the compartments must be equipped with buckets.
- Always load opposite compartments of the rotors with the same accessories and fill to avoid imbalance.

**Centrifugation with vessels of various sizes**

Working with vessel of various sizes is possible. In this case, however, it is very important that the rotationally symmetrical inserts are identical.

correct

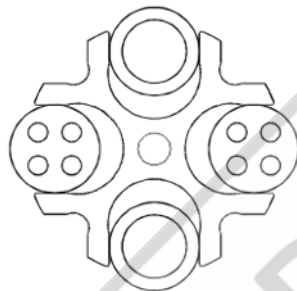

incorrect

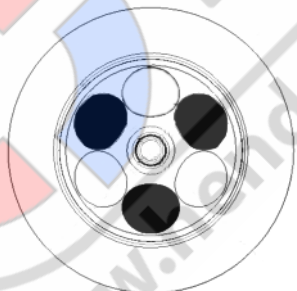

Fig. 7: Permissible and impermissible loading of a swing-out rotor with vessels of various sizes (example illustration)

**Centrifugation with low capacity**

- Install the sample vessels in a rotationally symmetrical manner so that the buckets and their suspensions are loaded evenly.
- It is not permissible to load angle rotors on only one axis.

correct



incorrect

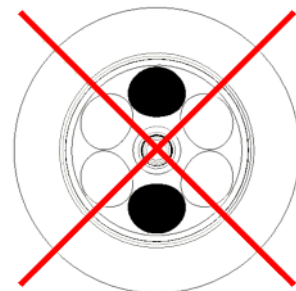

Fig. 8: Permissible and impermissible loading of an angle rotor and a swing-out rotor (example illustrations)

## 6 Using the centrifuge



Pay attention to the marking of the centrifuge (see the illustration below)! Safety indications on the centrifuge must be kept readable at all times. If necessary, they must be replaced.

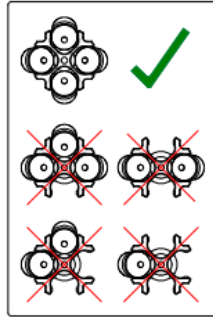

Fig. 9: Safety indication on the centrifuge: Loading of a swing-out rotor

### 6.2.2.5 Adapters

In order to ensure easy handling, even if vessels of various sizes are used, carrier systems were developed.

- Load the opposite adapters with the same number of vessels and with the same weights in order to avoid imbalance.
- If all of the compartments of a carrier are not used, the buckets must be loaded evenly. Loading the edges of a bucket only is not permissible.

### 6.2.2.6 Vessels

- Load the vessels outside of the centrifuge. Liquids in the buckets or multiple carriers cause corrosion.
- Fill the vessels carefully and arrange them according to their weight. Imbalances result in the excessive wear of the bearings.
- Always fill the tubes up to their useful volume (= the volume that is stated for the tube).
- Follow the safety instructions and hazard warnings (see chapter 3 - "Safety")!

#### Maximum speed for tubes

Some tubes, such as centrifuge glass tubes, microtubes, culture tubes, fluoropolymer tubes and especially high-volume tubes can be used in our rotors, buckets, and adapters at higher speeds than their breaking limit.



When using glass vessels, the maximum value of 4,000 x g must not be exceeded (except special high-strength glass tubes; please refer to the information provided by the manufacturer).



## 6.3 Control system "Spincontrol L"

### 6.3.1 User interface

The centrifuge is operated via three buttons with integrated light-emitting diodes and one function knob. The display is divided into several different fields. The various functions of the system can be called up by pressing and turning the function knob.

- 1 Start key
- 2 Function knob
- 3 Display
- 4 Stop key
- 5 Lid key

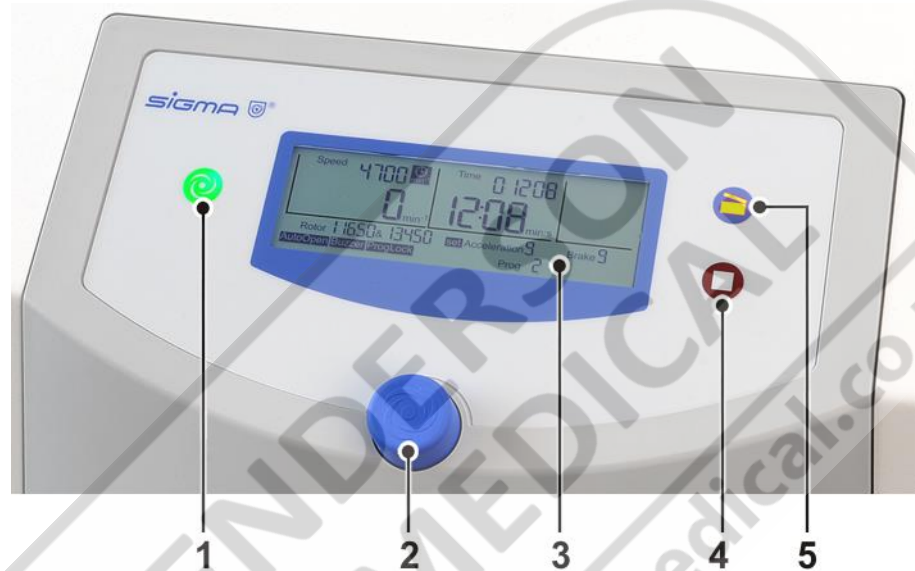

Fig. 10: User interface of the "Spincontrol L" control system

#### Display

The centrifuge display has the following display fields:

- 1 Speed/rcf field
- 2 Various display fields (e.g. for rotor, curve, or program selection)
- 3 Time field



Fig. 11: Display of the "Spincontrol L" control system

## 6 Using the centrifuge

---

### 6.3.2 Manual mode

#### 6.3.2.1 Starting a centrifugation run

The centrifuge is ready for operation when the start key is illuminated.

- Press the start key in order to start a centrifugation run.

#### 6.3.2.2 Interrupting a centrifugation run

- Press the stop key in order to interrupt a centrifugation run. The centrifugation run will be terminated prematurely.

##### Quick stop

- Press the stop key for more than two seconds.

The centrifuge decelerates with the maximum deceleration curve.

After a quick stop, the centrifuge lid must be opened before a new centrifugation run can be started.

A quick stop can also be triggered during a normal deceleration, e.g. in order to speed up the deceleration.

When a quick stop is triggered, "fast" will be displayed in the lower right-hand corner of the display.

#### 6.3.2.3 Interrupting a deceleration process

- Press the start key during a deceleration process in order to interrupt it and to restart the centrifuge.

#### 6.3.2.4 Selection, display, and modification of data

- Turn the function knob in order to select a field. The selected field will be preceded by the indication "set", "run", or "save".
- Press the function knob. The indication ("set", "run", or "save") flashes and the modification mode is active.
- Turn the function knob in order to modify the set value of the selected field.
- Press the function knob again to confirm the input and to quit the modification mode
- The process will be interrupted if the stop key is pressed or after 60 seconds without any further input.

### 6.3.2.5 Speed / relative centrifugal force (RCF)

The set speed of the centrifuge is displayed in the upper area of the Speed/RCF field. The actual value is displayed right below. The speed is stated as the number of revolutions per minute ( $\text{min}^{-1} = \text{rpm}$ ) and the RCF values as a multiple of the gravitational acceleration ( $\times g$ ). The values are interdependent (see chapter 2.2.2.1 - "Speed, radius, and relative centrifugal force"). The maximum speed/RCF values depend on the rotor that is used.

The parameters speed and RCF can be changed during the centrifugation.



Fig. 12: Setting the speed value or the RCF value

### 6.3.2.6 Runtime

The set runtime is displayed in the upper section of this field, with the remaining runtime shown below. The runtime is counted down from the set value, starting with the start of the centrifuge and ending with the start of the deceleration phase. The maximum runtime is 99 h:59 min:59 sec. As of 59 min:59 sec, the unit switches from "h:min" to "min:s".

The parameter runtime can be changed during the centrifugation.



If the runtime is changed during an active centrifugation run, the time that has already elapsed will not be taken into consideration. The centrifuge will perform a complete run with the new runtime.

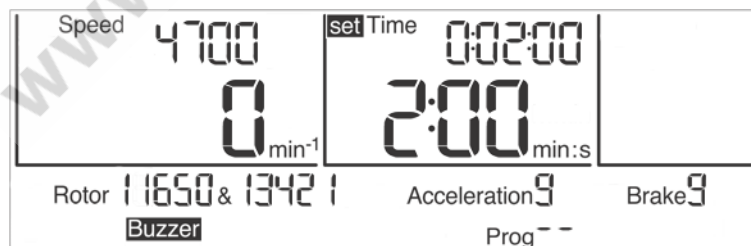

Fig. 13: Setting the runtime, here in the time unit "min:s"

## 6 Using the centrifuge

### Runtime as of the set speed

If the runtime is to be counted as of the moment when the set speed is reached, the symbol (see the illustration) behind the set speed value must be activated:

- Select the clock symbol with the cursor and confirm the selection. The symbol and the bar under the symbol start to flash.
- Activate the function by turning the function knob. The symbol remains displayed in a permanent manner and the bar continues to flash.
- Further turning of the function knob will deactivate the function. In this case, the symbol disappears but the bar continues to flash.
- Press the function knob in order to activate the desired setting. The bar remains visible as long as the cursor is placed on the symbol.



Fig. 14: The function "Runtime as of the set speed" is activated

### Continuous run

During the continuous run, the runtime of the centrifuge is unlimited and must be stopped manually. The centrifuge accelerates during the continuous run until the set speed is reached.

- Select the "Time" field and press the function knob. The indication "set" flashes in the activated status.
- Turn the function knob from the time 0:00:10 anti-clockwise or from the time 99:59:59 clockwise. The indication "Cont" will be displayed in the "Time" field. During the centrifugation run, the elapsed time will be displayed.
- Deactivate the continuous run by pressing the stop key or by entering a specific runtime.

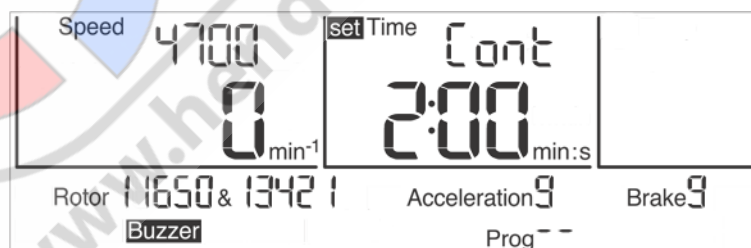

Fig. 15: Indication "Cont" during a continuous run

### Short run

A short run can be started if no run is active.

- Keep the start key pressed during the short run.

During the short run, the centrifuge accelerates with the acceleration curve 9 (maximum) until the maximum permissible speed of the rotor is reached. The runtime is counted and in the "Time" field the indication "Short" is displayed.

When the start key is released, the centrifuge decelerates to a standstill based on the maximum deceleration curve.

When the short run is completed, the original parameters (curves, runtime, and final speed) are restored and displayed.



Fig. 16: Indication "Short" during a short run

### 6.3.2.7 Rotor selection

This field shows the rotor that is currently being used.

**i**  
NOTE

The rotor selection can only be changed when the centrifuge is at a standstill.

- Select the "Rotor" field and confirm the selection. The indication "set" flashes in the activated status.
- Select the desired rotor. If there are rotors with several different types of possible buckets, the various combinations will be displayed one after the other.
- Confirm the input. The selected rotor or rotor/bucket combination will be adopted.



Fig. 17: Preselection of a rotor or a rotor/bucket combination

## 6 Using the centrifuge

### Automatic rotor identification system<sup>1</sup>

If the centrifuge is equipped with an automatic rotor identification system, the input mode will be activated automatically if the system detects a different rotor with several different types of possible buckets than the rotor that is set. The bucket that is displayed is the bucket with the lowest maximum speed. You can only select different types of buckets for the identified rotor. If the input mode is aborted, this bucket will be stored nonetheless.

This prevents the maximum permissible speed from being exceeded.

### 6.3.2.8 Acceleration and deceleration curves

#### Acceleration

This function is used to select an acceleration curve. The system offers 10 fixed, programmed acceleration curves (curves 0-9).

#### Brake

This function is used in order to select a curve that decelerates the centrifuge to a standstill. Deceleration curves are inverted images of the acceleration curves and are labelled with identical numbers. Deceleration curve no. 0 represents a brakeless deceleration.



Fig. 18: Preselection of a curve; here: preselection of an acceleration curve

<sup>1</sup> not available for Sigma 4-5L

### 6.3.2.9 Automatic lid opening function ("AutoOpen")

The automatic lid opening function must be activated so that the lid opens automatically at the end of the operation.

In order to activate the automatic lid opening function:

- Select the "Auto Open" symbol with the cursor and confirm the selection. The symbol and the bar under the symbol start to flash.
- Activate the function by turning the function knob. The symbol remains displayed in a permanent manner and the bar continues to flash.
- Turning the function knob further will deactivate the function. In this case, the symbol disappears but the bar continues to flash.
- Press the function knob in order to activate the desired setting. The bar remains visible as long as the cursor is placed over the symbol.



Fig. 19: The automatic lid opening function "Auto Open" is activated

### 6.3.2.10 Sound signal ("Buzzer")

This function is used to set an acoustic warning signal that sounds at the end of the centrifugation run and also in the event of an imbalance or error message.

In order to activate the sound signal:

- Select the "Buzzer" symbol with the cursor and confirm the selection. The symbol and the bar under the symbol start to flash.
- Activate the function by turning the function knob. The symbol remains displayed in a permanent manner and the bar continues to flash.
- Turning the function knob further will deactivate the function. In this case, the symbol disappears but the bar continues to flash.
- Press the function knob in order to activate the desired setting. The bar remains visible as long as the cursor is placed over the symbol.



Fig. 20: The sound signal "Buzzer" is activated

## 6 Using the centrifuge

### 6.3.2.11 Program lock ("ProgLock")

When the program lock is active, it is impossible to save any new programs. In this case, the function "save program" is disabled.

In order to activate the program lock:

- Select the "ProgLock" symbol with the cursor and confirm the selection. The symbol and the bar under the symbol start to flash.
- Activate the function by turning the function knob. The symbol remains displayed in a permanent manner and the bar continues to flash.
- Turning the function knob further will deactivate the function. In this case, the symbol disappears but the bar continues to flash.
- Press the function knob in order to activate the desired setting. The bar remains visible as long as the cursor is placed over the symbol.



Fig. 21: The program lock "ProgLock" is activated

### 6.3.2.12 Cycle display ("Cycles")

In order to activate the cycle display:

- Select the "Cycles" symbol with the cursor and confirm the selection. The symbol is displayed and "set" flashes in front of the rotor display.
- All of the rotors and buckets can be selected by turning the function knob. The cycles of the selected rotor and, if applicable, also of the selected bucket are displayed.
- Press the function knob in order to quit the cycle display.

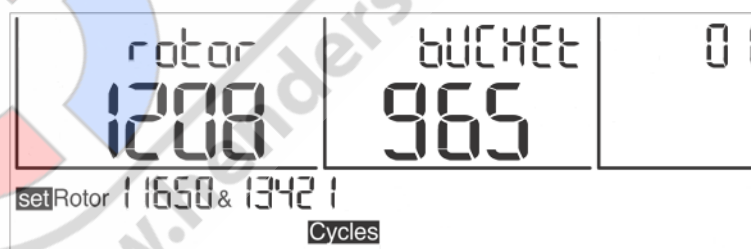

Fig. 22: Cycle display for rotor 11650 and bucket 13421

### Reaching the maximum number of cycles

When the maximum number of cycles is reached for a rotor or bucket, a corresponding warning signal will be displayed every time that the centrifuge is started: the start key, lid key, and entire display will flash.





Fig. 23: Display when the maximum number of cycles is reached (flashing)

When the start key is pressed, "CYCLES" will be displayed. The centrifuge will not be started and the display will not return to its normal state until the start key is pressed again.



**WARNING**

When the maximum number of cycles of the rotor or bucket is reached, the parts must be replaced immediately for safety reasons (see chapter 3.6.7.1 - "Service life").

The cycle display will be reset after the rotor and buckets have been replaced by the service department of Sigma Laborzentrifugen GmbH (see chapter 7.3 - "Service contact").

### 6.3.2.13 Input lock

In order to prevent the centrifuge from being manipulated by unauthorised persons, inputs can be disabled via the menu. Inputs via the keypad, i.e. for starting or stopping a centrifugation run or for opening the lid, are enabled.

#### Activating a simple input lock:

- Position the cursor over the symbol "🔒" in the lower right-hand corner of the display.

As long as the symbol is displayed, the parameters of the centrifuge cannot be changed.

#### Activating a permanent input lock:

- Press the start key three times and hold for approximately 2 seconds when pressing it for the third time.

After the activation of this function, the padlock symbol flashes. The input lock is activated.

- Proceed in the same manner in order to deactivate the permanent input lock.



Fig. 24: "Padlock" symbol indicating an activated input lock

## 6 Using the centrifuge

### 6.3.3 Program mode

A program contains all the data that are required for a centrifuge run. Certain sedimentation results can be repeated under identical conditions. Programs can be saved, loaded, executed, and edited, when the centrifuge is at a standstill.

A maximum of 50 programs can be stored under the numbers 1 - 50.

"--" means that the values that are currently set are not a stored program.

The programs can be protected against unauthorised use, modification, or deletion with the aid of an input lock (see chapter 6.3.2.13 - "Input lock").

#### 6.3.3.1 Saving a program



This function is only available if the centrifuge is at a standstill.

- Enter the parameters that are to be included in the program.
- Select the menu item "save Prog" and confirm the selection. The indication "save" flashes in the activated status.
- Select a random storage location from the program selection list. Free storage locations are indicated by a flashing display. Any storage locations that are already occupied will be overwritten during the saving process.
- Save the program in the desired location.

The program is now saved.



The functions "Auto Open", "Buzzer", "ProgLock", and "Cycles" cannot be entered as part of a program.



Fig. 25: Saving a program

**6.3.3.2 Loading a program**

- Select the menu item "run Prog" and confirm the selection. The indication "run" flashes in the activated status.
- Select the desired program and confirm the selection by pressing the function knob.

The program is now loaded.



Fig. 26: Loading a program

**6.4 Switching the centrifuge off**

- Open the centrifuge when it is not in use so moisture can evaporate.
- Switch the centrifuge off by pressing the mains power switch.

## 7 Malfunctions and error correction

# 7 Malfunctions and error correction

## 7.1 General malfunctions

Error messages are displayed as "Error" followed by a code number. If the acoustic signal is activated, it sounds when the error message is displayed.

- Eliminate the source of the problem (see table below).
- Acknowledge the error messages by pressing the lid key.



Error messages can be eliminated by pressing the lid key. The error itself will not be eliminated, but the centrifuge can be operated again.

Type of error	Possible reason	Correction
No indication on the display	No power in the mains supply	Check fuse in the mains supply
	Power cord is not plugged in	Plug in power cord correctly
	Fuses have tripped	Reactivate temperature fuse (see chapter 5.2.1 - "Type of connection")
	Mains power switch off	Switch mains power switch on
Centrifuge cannot be started: start key LED is not illuminated	Several possible causes	Power off/on. If the error occurs again, contact service
Centrifuge cannot be started: lid key LED flashes	The lid lock is not closed correctly	Open and close the lid. If the error occurs again, contact service
Centrifuge decelerates during operation	Brief mains power failure	Press start key in order to restart the centrifuge
	System error	Power off/on. If the error occurs again, contact service
Centrifuge decelerates during operation, imbalance message is displayed	– Improper loading	Balance load and restart the centrifuge. If the error occurs again, contact service (see chapter 7.1.1 - "Emergency lid release")
	– Centrifuge is inclined	
	– Drive problem	
	– Centrifuge was moved during run	
Lid cannot be opened	– Ungreased load-bearing bolts	Clean and grease load-bearing bolts
	Lid lock has not released	Unlock the lid manually and contact service
Lid cannot be opened	Lid seal sticks	Clean the lid seal and apply talcum powder
	Temperature value cannot be reached (only for refrigerated centrifuges)	Condenser dirty (only air-cooled units)

### 7.1.1 Emergency lid release

In the event of a power failure, it is possible to manually open the centrifuge lid.

- Switch off the mains power switch and disconnect the power cord from the socket.
- Remove the stopper (see figure, item 1) from the opening at the side panel, e.g. with a screwdriver.



Fig. 27: Position of the opening for the emergency lid release

- The stopper is connected with a string. Pull the string in order to release the lid.
- Then, reinsert the stopper into the opening.



**WARNING**

Do not unlock or open the lid unless the rotor is at a standstill.

If the lid is opened via the emergency lid release system during a centrifuge run, the centrifuge will be switched off immediately and decelerate in an unbraked manner.

## 7 Malfunctions and error correction

### 7.2 Table of error codes

Error no.	Kind of error	Measures	Note
1-9	System error	<ul style="list-style-type: none"> <li>Allow to slow down</li> <li>Power off/on</li> </ul>	All these errors stop the centrifuge or cause it to decelerate brakeless
10-19	Speedometer error	<ul style="list-style-type: none"> <li>Allow to slow down</li> <li>Power off/on</li> </ul>	
20-29	Motor error	<ul style="list-style-type: none"> <li>Power off</li> <li>Ensure ventilation</li> </ul>	
30-39	EEPROM error	<ul style="list-style-type: none"> <li>Allow to slow down</li> <li>Power off/on</li> </ul>	With error 34, 35, and 36, the centrifuge will stop; with error 37 and 38 only an error message will be given
40-45	Temperature error (only for refrigerated centrifuges)	<ul style="list-style-type: none"> <li>Allow to slow down</li> <li>Power off</li> <li>Allow to cool down</li> <li>Provide better ventilation (only air cooled centrifuges)</li> <li>Provide sufficient water throughput (only water cooled centrifuges)</li> </ul>	
46-49	Imbalance error (only for centrifuges with imbalance monitoring system)	<ul style="list-style-type: none"> <li>Allow to slow down</li> <li>Power off</li> <li>Eliminate the imbalance</li> </ul>	
50-59	Lid error	<ul style="list-style-type: none"> <li>Press lid key</li> <li>Close lid</li> <li>Remove foreign matter from the opening of the lid lock device</li> </ul>	With error 50 and 51, the centrifuge will stop
60-69	Process error	<ul style="list-style-type: none"> <li>Allow to slow down</li> <li>Power off/on</li> </ul>	With error 60, the message "power failure during run" will be displayed, with error 61, the message "stop after power on" will be displayed
70-79	Communication error	<ul style="list-style-type: none"> <li>Allow to slow down</li> <li>Power off/on</li> </ul>	
80-89	Parameter error	<ul style="list-style-type: none"> <li>Power off</li> <li>Allow to cool down</li> <li>Provide for better ventilation</li> </ul>	With error 83, error message only
90-99	Other errors	<ul style="list-style-type: none"> <li>Check connections</li> <li>Provide sufficient water throughput (only water cooled centrifuges)</li> </ul>	



If it is impossible to eliminate the errors, contact the service!

### 7.3 Service contact

In the event of queries, malfunctions, or spare part enquiries:

**From Germany:**

Contact

Sigma Laborzentrifugen GmbH  
An der Unteren Söse 50  
37520 Osterode (Germany)  
Tel. +49 (0) 55 22 / 50 07-44 44  
E-mail: support.lab@sigma-zentrifugen.de

**Outside Germany:**

Contact our agency in your country. All agencies are listed at  
[www.sigma-zentrifugen.de](http://www.sigma-zentrifugen.de) → [Sales Partners]



- If you would like to utilise our service, please state the type of your centrifuge and its serial number.

## 8 Maintenance and service

### 8 Maintenance and service

The centrifuge, rotor, and accessories are subject to high mechanical stress. Thorough maintenance performed by the user extends the service life and prevents premature failure.



#### CAUTION

If corrosion or other damage occurs due to improper care, the manufacturer cannot be held liable or subject to any warranty claims.

- Use soap water or other water-soluble, mild cleaning agents with a pH value between 6 and 8 for cleaning the centrifuge and accessories (see also chapter 8.2 - "Sterilisation and disinfection of the rotor chamber and accessories").
- Avoid corrosive and aggressive substances.
- Do not use solvents.
- Do not use agents with abrasive particles.
- Do not expose the centrifuge and rotors to intensive UV radiation or thermal stress (e.g. by heat generators).

#### 8.1 Maintenance

##### 8.1.1 Centrifuge

- Unplug the mains power plug before cleaning.
- Carefully remove all liquids, including water and particularly all the solvents, acids, and alkaline solutions from the rotor chamber using a cloth in order to avoid damage to the motor bearings.
- If the centrifuge has been contaminated with toxic, radioactive, or pathogenic substances, clean the rotor chamber immediately with a suitable decontamination agent (depending on the type of contamination).



#### WARNING

Take suitable precautions for your own safety if there is a risk of toxic, radioactive, or pathogenic contamination.

- After every cleaning process, grease the motor shaft slightly with a small amount of heavy-duty grease for load-bearing bolts (part no. 71401) and distribute the grease with a cloth so that it forms a thin layer.



**8.1.2 Accessories****CAUTION**

For the care of the accessories, special safety measures must be considered as these are measures that will ensure operational safety at the same time!

- Immediately rinse off the rotor, buckets, or accessories under running water if they have come into contact with any liquids that may cause corrosion. Use a brush for test tubes in order to clean the bores of angle rotors. Turn the rotor upside down and allow it to dry completely.
- Clean the accessories outside the centrifuge once a week or preferably after each use. Adapters should be removed, cleaned and dried.

**CAUTION****Do not clean the accessories in a dishwasher!**

Cleaning in a dishwasher removes the anodised coating; the result is cracking in areas that are subject to stress.

- If the rotors or accessories have been contaminated with toxic, radioactive, or pathogenic substances, clean them immediately with a suitable decontamination agent (depending on the type of contamination). Take suitable precautions for your own safety if there is a risk of toxic, radioactive, or pathogenic contamination.
- Dry the accessories with a soft cloth or in a drying chamber at approx. 50°C.

**8.1.2.1 Plastic accessories**

The chemical resistance of plastic decreases with rising temperatures (see chapter 11.5 - "Resistance data").

- If solvents, acids, or alkaline solutions have been used, clean the plastic accessories thoroughly.

**WARNING**

Plastic accessories must not be greased!

## 8 Maintenance and service

---

### 8.1.3 Rotors, buckets and carriers

Rotors, buckets and carriers are produced with the highest precision, in order to withstand the permanent high stress from high gravitational fields. Chemical reactions as well as stress-corrosion (combination of oscillating pressure and chemical reaction) can affect or destroy the metals. Barely detectable cracks on the surface can expand and weaken the material without any visible signs.

- Check the material regularly (at least once a month) for
  - cracks
  - visible damage of the surface
  - pressure marks
  - signs of corrosion
  - other changes.
- Check the bores of the rotors and multiple carriers.
- Replace any damaged components immediately for your own safety.
- After every cleaning process, grease the rotor tie-down screw slightly with a small amount of heavy-duty grease for load-bearing bolts (part no. 71401) and distribute the grease with a cloth so that it forms a thin layer.

### 8.1.4 Load bearing bolts

Only greased load-bearing bolts ensure a uniform swing-out of the buckets and, therefore, the smooth operation of the centrifuge. Load-bearing bolts that are insufficiently greased may cause the centrifuge to stop due to an imbalance.

- Clean the load-bearing bolts and bucket groove in order to remove the old grease.
- Apply a small amount of heavy-duty grease for load-bearing bolts (ref. no. 71401, see the following picture) to both load-bearing bolts of a bucket.



Fig. 28: Sufficient quantity of grease for one bolt

- Install the bucket and swing it manually back and forth once in order to distribute the grease.
- Repeat this process with all the other buckets.

## 8 Maintenance and service

### 8.1.5 Glass breakage



#### CAUTION

In the case of glass breakage, immediately remove all glass particles (e.g. with a vacuum cleaner). Replace the rubber cushions since even thorough cleaning will not remove all glass particles.

Glass particles will damage the surface coating (e.g. anodising) of the buckets, which will then lead to corrosion.

Glass particles in the rubber cushions of the buckets will cause glass breakage again.

Glass particles on the pivot bearing of the load-bearing bolts prevent the buckets and carriers from swinging evenly, which will cause an imbalance.

Glass particles in the rotor chamber will cause metal abrasion due to the strong air circulation. This metal dust will not only pollute the rotor chamber, rotor, and materials to be centrifuged but also damage the surfaces of the accessories, rotors, and rotor chamber.

#### **In order to completely remove the glass particles and metal dust from the rotor chamber:**

- Grease the upper third of the rotor chamber with e.g. Vaseline.
- Then, let the rotor rotate for a few minutes at a moderate speed (approx. 2000 rpm). The glass and metal particles will now collect at the greased part.
- Remove the grease with the glass and metal particles with a cloth.
- If necessary, repeat this procedure.

### 8.2 Sterilisation and disinfection of the rotor chamber and accessories

- Use commercially-available disinfectants such as, for example, Sagrotan®, Buraton®, or Terralin® (available at chemist's shops or drugstores).
- The centrifuge and the accessories consist of various materials. A possible incompatibility must be considered.
- Before using cleaning or decontamination agents that were not recommended by us, contact the manufacturer to ensure that such a procedure will not damage the centrifuge.
- For autoclaving, consider the continuous heat resistance of the individual materials (see chapter 8.2.1 - "Autoclaving").

Please contact us if you have any queries (see chapter 7.3 - "Service contact").



#### DANGER

If dangerous materials (e.g. infectious and pathogenic substances) are used, the centrifuge and accessories must be disinfected.

### 8.2.1 Autoclaving

The service life of the accessories essentially depends on the frequency of autoclaving and use.

- Replace the accessories immediately when the parts show changes in colour or structure or in the occurrence of leaks etc.
- During autoclaving, the caps of the tubes must not be screwed on in order to avoid the deformation of the tubes.



It cannot be excluded that plastic parts, e.g. lids or carriers, may deform during autoclaving.

Accessories	Max. temp. (°C)	Min. time (min)	Max. time (min)	Max. cycles
Aluminium buckets	134-138	3	5	-
Aluminium rotors	134-138	3	5	-
Glass tubes	134-138	3	40	-
Polyallomer / polycarbonate rectangular carriers	115-118	30	40	-
Polyallomer / polycarbonate round carriers	115-118	30	40	-
Polyamide buckets	115-118	30	40	10
Polycarbonate / polyallomer lids for angle rotors	115-118	30	40	20
Polycarbonate tubes	115-118	30	40	20
Polyphenylsulfone (PPSU) caps for buckets	134-138	3	5	100
Polypropylene balance adapter for blood-bag systems	115-118	30	40	n.s.
Polypropylene copolymer tubes	115-121	30	40	20
Polypropylene rectangular carriers	115-118	30	40	-
Polypropylene rotors	115-118	30	40	20
Polypropylene round carriers	115-118	30	40	-
Polysulfone caps for buckets	134-138	3	5	100
Polysulfone lids for angle rotors	134-138	3	5	100
Rubber adapters	115-118	30	40	-
Stainless-steel balance weight for blood-bag systems	121	30	30	n.s.
Teflon tubes	134-138	3	5	100

## 8 Maintenance and service

### 8.3 Service



**DANGER**

In the event of service work that requires the removal of the panels, there is a risk of electric shock or mechanical injury.

- Only qualified specialist personnel is authorised to perform this service work.
- Following the completion of any type of service, the qualified and specialised personnel must perform final inspection and testing in compliance with the relevant standards.

The centrifuge is subject to high mechanical stress. In order to be able to withstand this high level of stress, high-quality components were used during the production of the centrifuge. Nevertheless, wear cannot be excluded and it may not be visible from the outside. Especially the rubber parts that are – among other things – part of the motor suspension, are subject to ageing.

This is why we recommend having the centrifuge checked by the manufacturer during an inspection once per year in the operating state and once every three years in the dismantled state. Rubber parts should be replaced after three years.

Information and appointments:

#### **In Germany:**

Contact  
Sigma Laborzentrifugen GmbH  
An der Unteren Söse 50  
37520 Osterode (Germany)  
Tel. +49 (0) 55 22 / 50 07-44 44  
E-mail: support.lab@sigma-zentrifugen.de

#### **Outside Germany:**

Contact our agency in your country. All agencies are listed at [www.sigma-zentrifugen.de](http://www.sigma-zentrifugen.de) → [Sales Partners]



**NOTE**

- If you would like to utilise our service, please state the type of your centrifuge and its serial number.

## 8.4 Return of defective centrifuges or parts

Although we exercise great care during the production of our products, it may be necessary to return a unit or accessory to the manufacturer.

In order to ensure the quick and economical processing of returns of centrifuges, spare parts, or accessories, we require complete and extensive information concerning the process. Please fill in the following forms completely, sign them, enclose them with the return package, and send them together with the product to:

Sigma Laborzentrifugen GmbH  
An der Unteren Söse 50  
37520 Osterode (Germany)

### 1. Declaration of decontamination

As a certified company and due to the legal regulations for the protection of our employees and of the environment, we are obliged to certify the harmlessness of all incoming goods. For this purpose, we require a declaration of decontamination.

- The form must be filled in completely and signed by authorised and specialised personnel only.
- Affix the original form in a clearly visible manner to the outside of the packaging.



We will return the part/unit if no declaration of decontamination is provided!

### 2. Form for the return of defective parts

This form is for the product-related data. They facilitate the assignment, and they enable the quick processing of the return. If several parts are returned together in one packaging, please enclose a separate problem description for every defective part.

- A detailed problem description is necessary in order to perform the repair quickly and economically.



If the form does not include a description of the malfunction, neither a refund nor a credit note can be issued. In this case, we reserve the right to return the part/unit to you at your expense.

- Upon request, we will prepare and submit to you a cost estimate prior to performing the repair. Please confirm such cost estimate within 14 days. If the cost estimate has still not been confirmed after 4 weeks, we will return the defective part/unit. Please note that you must bear the incurred costs.

## 8 Maintenance and service



The defective part/unit must be packaged in a transport-safe manner. Please use the original packaging for the unit, if at all possible. If the product is dispatched to us in unsuitable packaging, you will be charged the cost for returning it to you in new packaging.

The forms can be downloaded online from  
[www.sigma-zentrifugen.de](http://www.sigma-zentrifugen.de) → [Service] → [Overhaul and repair].





## 9 Disposal

### 9.1 Disposal of the centrifuge



In accordance with the directive 2012/19/EU, SIGMA centrifuges are marked with the symbol shown to the left. This symbol means that it is not permissible to dispose of the unit among household waste.

- You can return these centrifuges free of cost to Sigma Laborzentrifugen GmbH.
- Ensure that the unit is decontaminated. Fill in a declaration of decontamination (see chapter 8.4 - "Return of defective centrifuges or parts").
- Comply with any other applicable local rules and regulations.

### 9.2 Disposal of the packaging

- Use the packaging to return the centrifuge for disposal or
- dispose of the packaging, after having separated the individual materials.
- Comply with all local rules and regulations.

## 10 Technical data

### 10 Technical data

<b>Manufacturer</b>	<b>Sigma Laborzentrifugen GmbH An der Unteren Söse 50 37520 Osterode (Germany)</b>	
Type:	3-16L	3-16L IVD
Part no.:	10355, 10356, 10357	10358, 10359
<u>Connection requirements</u>		
Electr. connection:	see name plate	
Protection class:	I	
IP code:	20	
Power consumption (kW):	0.50 (at 220-240 V / 50/60 Hz) 0.50 (at 120 V / 60 Hz) 0.55 (at 100 V / 50/60 Hz)	
Thermal circuit breaker (A):	4.0 (at 220-240 V / 50/60 Hz) 8.0 (at 120 V / 60 Hz) 10.0 (at 100 V / 50/60 Hz)	
<u>Performance data</u>		
Max. speed (rpm):	15,300	
Max. capacity (ml):	1,600 (4 x 400)	
Max. gravitational field (x g):	21,475	
Max. kin. energy (Nm):	9,530	
<u>Other parameters</u>		
Time range:	10 sec – 99 h 59 min, short run, continuous run	
Storage locations:	50	
<u>Physical data</u>		
Height (mm):	355	
Height with open lid (mm):	770	
Width (mm):	460	
Depth (mm):	600	
Weight (kg):	48	
Noise level (dB(A)):	57 (at maximum speed)	

## 10.1 Ambient conditions

- The figures are valid for an ambient temperature of +23°C and a nominal voltage  $\pm 10\%$ .



At a nominal voltage of 100V or 200V, a tolerance of +10% / -5% applies.

- For indoor use only.
- Allowable ambient temperature +5°C to +40°C.
- Max. allowable relative humidity of air 80% from 5°C up to 31°C with a linear decrease to 50% relative humidity of air at 40°C.
- Maximum altitude 2,000 m above sea level.

## 10.2 Technical documentation

For environmental reasons, the comprehensive technical documentation of the centrifuge (e.g. circuit diagrams) and the safety data sheets of the manufacturers of refrigerants and lubricants are not attached to this documentation.

You can order these documents from our service department.

## 11 Appendix

# 11 Appendix

## 11.1 Range of accessories

The complete list of accessories can be downloaded from [www.sigma-zentrifugen.de](http://www.sigma-zentrifugen.de).

### 11.1.1 Rotor radii

The information in the accessories table concerning the radius refers to the values of the respective rotor as shown below. The radius calculation is described in chapter 2.2.2.1 - "Speed, radius, and relative centrifugal force".

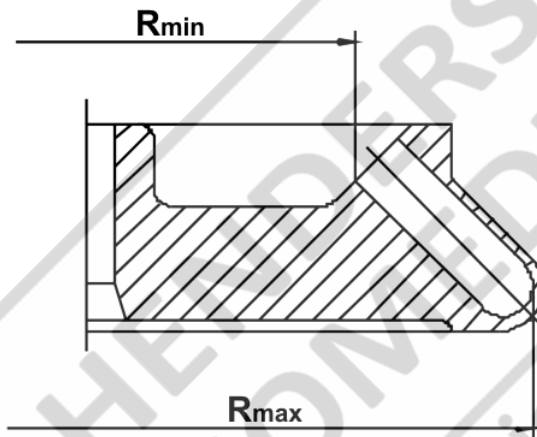

Fig. 29: Minimum and maximum radius of an angle rotor

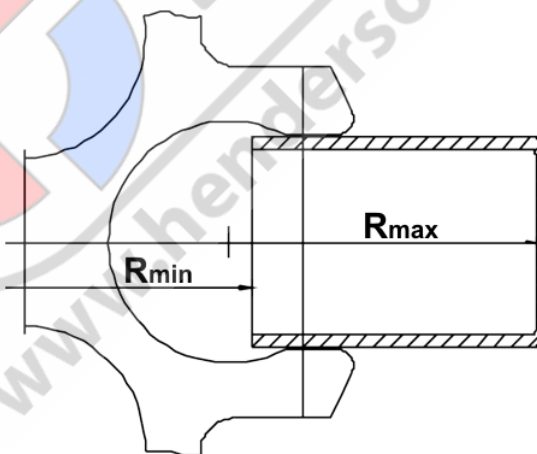

Fig. 30: Minimum and maximum radius of a swing-out rotor

## 11.2 Speed-gravitational-field-diagram

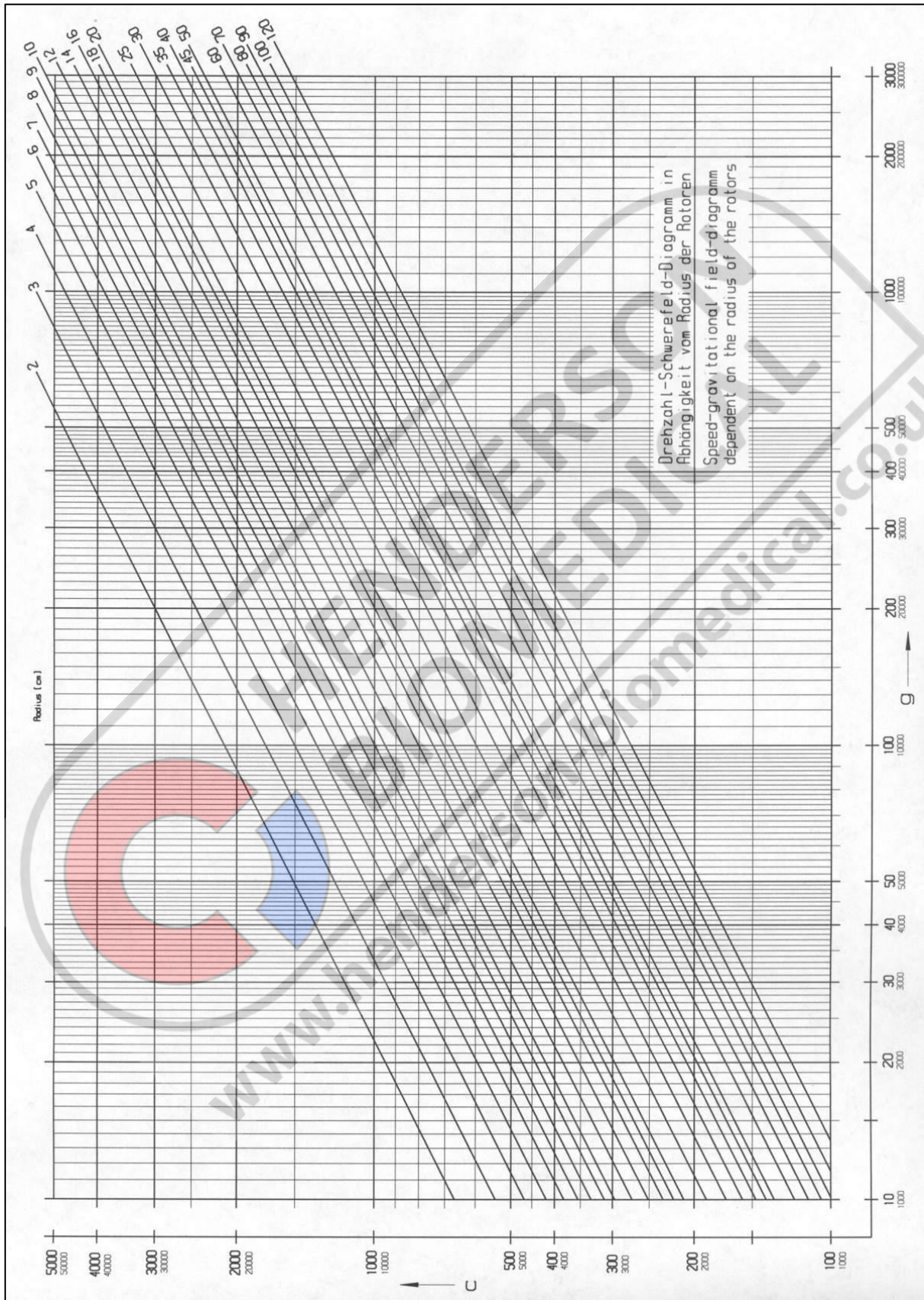

Fig. 31: Speed-gravitational-field-diagram

## 11 Appendix

### 11.3 Acceleration and deceleration curves

Linear curves are numbered in the direction of increasing acceleration (from right to left).

The deceleration curves are inverted images of the acceleration curves and are assigned the same numbers. An exception is curve 0. It decelerates brakeless (spin-out).

In general, the runtime, until the set speed is reached, depends on the moment of inertia of the rotor.

#### Linear curves

The slope of the fixed acceleration curves defines the time that is required to accelerate the rotor by 1,000 rpm.

Curve 9 is a special case compared to the other curves. The centrifuge accelerates with maximum power. The runtime, until the set speed is reached, depends solely on the moment of inertia of the rotor.

Linear curve no.	Slope
0	4 [rpm/sec]
1	6 [rpm/sec]
2	8 [rpm/sec]
3	17 [rpm/sec]
4	25 [rpm/sec]
5	33 [rpm/sec]
6	50 [rpm/sec]
7	100 [rpm/sec]
8	200 [rpm/sec]
9	1.000 [rpm/sec]

Fig. 32: Slope of linear curves

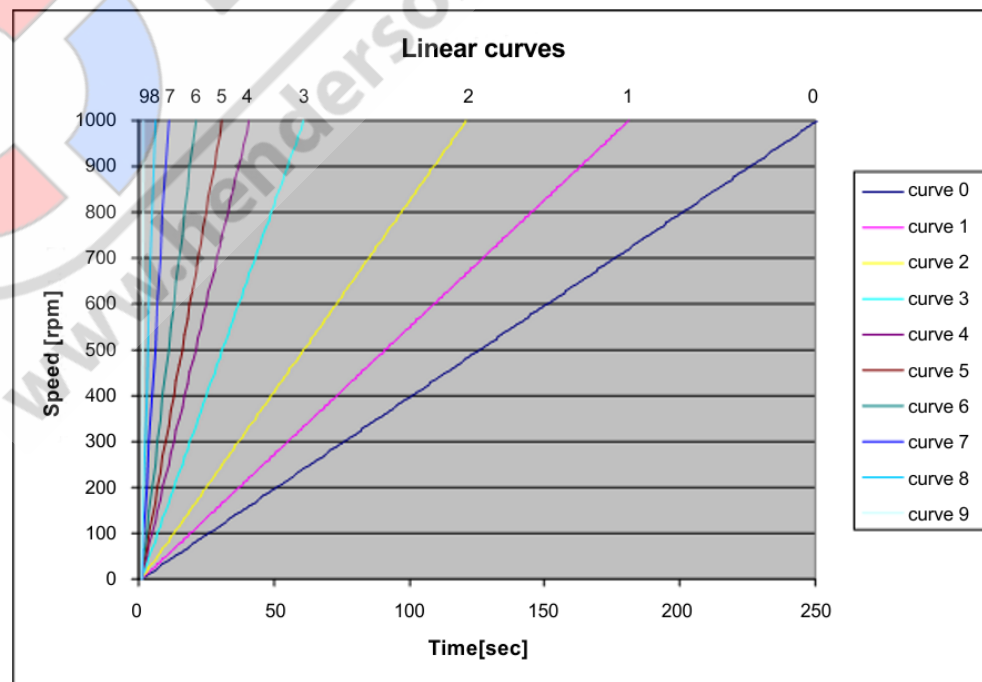

Fig. 33: Diagram of linear curves

## 11.4 Table of the service life of rotors and accessories

- If no other data concerning the service life are engraved on the rotor or accessory, rotors and buckets must be checked by the manufacturer after 10 years.
- If a specification concerning the maximum number of cycles **and** a specification concerning the service life (i.e. a date) are provided, the specification that occurs first shall apply.
- After 50,000 cycles, rotors must be scrapped for safety reasons.

Rotor / bucket	Cycles	Service life ("Exp.Date")	Autoclaving	Suitable for centrifuge	Remarks
9100	15,000			4-15C, 4K15C, 4-16, 4-16S, 4-16K, 4-16KS, 6-15, 6K15, 6-16, 6-16K	without engraving, only "spincontrol professional" and "spincontrol S"
11026		7 years		1-14, 1-14K	
11805 / 13850	10,000	10 years		8K, 8KB, 8KS, 8KBS	
11805 / 13860	10,000	10 years		8K, 8KB, 8KS, 8KBS	
11806		10 years		8K, 8KB, 8KS, 8KBS	
12033		5 years		1-16 Edition, 1-16K Edition	
12082		7 years		1-14, 1-14K	
12083		7 years		1-14, 1-14K	
12084		7 years		1-14, 1-14K	
12085		7 years		1-14, 1-14K	
12092		5 years	20x	1-14, 1-14K	
12093		5 years	20x	1-14, 1-14K	
12094		5 years	20x	1-14, 1-14K	
12096		5 years	20x	1-14, 1-14K	
12097		5 years	20x	1-14, 1-14K	
12101		5 years	20x	1-15, 1-15K, 1-15P, 1-15PK	
12124		5 years	20x	1-15, 1-15K, 1-15P, 1-15PK	
12126		5 years	20x	1-15, 1-15K, 1-15P, 1-15PK	
12134		5 years	20x	1-16, 1-16K	
12135		5 years	20x	1-16, 1-16K	
12137		5 years	20x	1-16, 1-16K	
12500		7 years		6-15, 6K15, 6-16, 6-16K	
12600		7 years		6-16S, 6-16KS	
13218	20,000			4-16, 4-16S, 4-16K, 4-16KS, 6-16, 6-16S, 6-16K, 6-16KS	
13296	35,000	5 years	10x	2-6, 2-6E, 2-7, 2-16P, 2-16KL, 2-16KHL	
13299		5 years	10x	2-6, 2-6E, 2-7, 2-16P, 2-16KL, 2-16KHL	
13635	25,000			6-16, 6-16K, 6-16S, 6-16KS	
13650	20,000			4-5L, 4-16S, 4-16KS, 4-16KHS, 6-16S, 6-16HS, 6-16KS, 6-16KHS	
13845	20,000			8K, 8KB, 8KS, 8KBS	
13850	10,000*	10 years		8K, 8KB, 8KS, 8KBS	*in combination with rotor 11805
13860	15,000*	10 years		8K, 8KB, 8KS, 8KBS	*in combination with rotor 11805
13864	1,000			8K, 8KB, 8KS, 8KBS	without engraving
13865	1,000			8K, 8KB, 8KS, 8KBS	without engraving
13866	1,000			8K, 8KB, 8KS, 8KBS	without engraving
13867	2,500			8K, 8KB, 8KS, 8KBS	without engraving
13868	5,000			8K, 8KB, 8KS, 8KBS	without engraving
13869	5,000			8K, 8KB, 8KS, 8KBS	without engraving
13870	5,000			8K, 8KB, 8KS, 8KBS	without engraving

## 11 Appendix

### 11.5 Resistance data



The data refer to resistance at 20°C.

Medium	Formula	Concentration [%]	High Density Polyethylene	Polyamide	Polycarbonate	Polyoxymethylene	Polypropylene	Polysulfone	Polyvinyl chloride, hard	Polyvinyl chloride, soft	Polytetrafluoroethylene	Acrylonitrile-butadiene-caoutchouc	Aluminium
			HDPE	PA	PC	POM	PP	PSU	PVC	PVC	PTFE	NBR	AL
- no data 1 resistant 2 practically resistant 3 partially resistant 4 not resistant													
Acetaldehyde	C <sub>2</sub> H <sub>4</sub> O	40	3	2	4	2	3	4	4	-	1	4	1
Acetamide	C <sub>2</sub> H <sub>5</sub> NO	saturated	1	1	4	1	1	4	4	-	1	-	1
Acetone	C <sub>3</sub> H <sub>6</sub> O	100	1	1	4	1	1	4	4	-	1	4	1
Acrylonitrile	C <sub>3</sub> H <sub>3</sub> N	100	1	1	4	3	3	4	4	4	1	4	1
Allyl alcohol	C <sub>3</sub> H <sub>6</sub> O	96	1	3	3	2	2	2	2	4	1	1	1
Aluminium chloride	AlCl <sub>3</sub>	saturated	1	3	2	4	1	-	1	-	1	1	4
Aluminium sulfate	Al <sub>2</sub> (SO <sub>4</sub> ) <sub>3</sub>	10	1	1	1	3	1	1	1	1	1	1	1
Ammonium chloride	(NH <sub>4</sub> )Cl	aqueous	1	1	1	2	1	1	1	1	1	1	3
Ammonium hydroxide	NH <sub>3</sub> + H <sub>2</sub> O	30	1	3	4	1	1	2	1	-	1	-	1
Aniline	C <sub>6</sub> H <sub>7</sub> N	100	1	3	4	1	2	4	4	4	1	4	1
Anisole	C <sub>7</sub> H <sub>8</sub> O	100	3	4	4	1	4	4	2	-	1	4	1
Antimony trichloride	SbCl <sub>3</sub>	90	1	4	1	4	1	-	1	-	1	-	4
Benzaldehyde	C <sub>7</sub> H <sub>6</sub> O	100	1	3	4	1	1	3	4	4	1	4	1
Benzene	C <sub>6</sub> H <sub>6</sub>	100	3	2	4	1	3	4	4	-	1	4	1
Boric acid	H <sub>3</sub> BO <sub>3</sub>	aqueous	1	3	1	2	1	-	-	-	1	1	1
Butyl acrylate	C <sub>7</sub> H <sub>12</sub> O <sub>2</sub>	100	1	2	4	2	3	4	4	4	1	-	1
Butyl alcohol, normal	C <sub>4</sub> H <sub>10</sub> O	100	1	1	2	1	1	2	2	4	1	1	1
Calcium chloride	CaCl <sub>2</sub>	alcoholic	1	4	2	3	1	-	-	4	1	1	3
Carbon disulfide	CS <sub>2</sub>	100	4	3	4	2	4	4	4	4	1	3	1
Carbon tetrachloride (TETRA)	CCl <sub>4</sub>	100	4	4	4	2	4	4	4	4	1	3	1
Chlorine	Cl <sub>2</sub>	100	4	4	4	4	4	4	4	4	1	-	3
Chlorine water	Cl <sub>2</sub> x H <sub>2</sub> O		3	4	4	4	3	-	3	3	1	-	4
Chlorobenzene	C <sub>6</sub> H <sub>5</sub> Cl	100	3	4	4	1	3	4	4	4	1	4	1
Chloroform	CHCl <sub>3</sub>	100	3	3	4	4	3	4	4	4	1	4	3



**11 Appendix**

- no data 1 resistant 2 practically resistant 3 partially resistant 4 not resistant		Concentration	High Density Polyethylene	Polyamide	Polycarbonate	Polyoxymethylene	Polypropylene	Polysulfone	Polyvinyl chloride, hard	Polyvinyl chloride, soft	Polytetrafluorethylene	Acrylonitrile-butadiene-caoutchouc	Aluminium	
			Medium	Formula	[%]	HDPE	PA	PC	POM	PP	PSU	PVC	PVC	PTFE
	Chromic acid	CrO <sub>3</sub>	10	1	4	2	4	1	4	1	-	1	4	1
	Chromic potassium sulphate	KCr(SO <sub>4</sub> ) <sub>2</sub> x 12H <sub>2</sub> O	saturated	1	2	1	3	1	-	1	-	1	-	3
	Citric acid	C <sub>6</sub> H <sub>8</sub> O <sub>7</sub>	10	1	1	1	2	1	1	1	1	1	1	1
	Citric acid	C <sub>6</sub> H <sub>8</sub> O <sub>7</sub>	50	1	3	1	2	1	-	-	-	1	1	1
	Copper sulphate	CuSO <sub>4</sub> x 5H <sub>2</sub> O	10	1	1	1	1	1	1	1	1	1	1	4
	Cyclohexanol	C <sub>6</sub> H <sub>12</sub> O	100	1	1	3	1	1	1	1	4	1	2	1
	Decane	C <sub>10</sub> H <sub>22</sub>	100	-	1	2	1	3	-	-	-	1	2	1
	Diaminoethane	C <sub>2</sub> H <sub>8</sub> N <sub>2</sub>	100	1	1	3	1	1	-	3	4	1	1	1
	Diesel fuel	—	100	1	1	3	1	1	-	1	3	1	1	1
	Dimethyl formamide (DMF)	C <sub>3</sub> D <sub>7</sub> NO	100	1	1	4	1	1	4	3	-	1	3	1
	Dimethyl sulfoxide (DMSO)	C <sub>2</sub> H <sub>6</sub> SO	100	1	2	4	1	1	4	4	-	1	-	1
	Dimethylaniline	C <sub>8</sub> H <sub>11</sub> N	100	-	3	4	2	4	-	-	-	1	-	1
	Dioxane	C <sub>4</sub> H <sub>8</sub> O <sub>2</sub>	100	2	1	4	1	3	2	3	4	1	3	1
	Dipropylene glycol (mono)methyl ether	C <sub>4</sub> H <sub>10</sub> O	100	3	1	4	1	4	4	4	4	1	-	1
	Ethyl acetate	C <sub>4</sub> H <sub>8</sub> O <sub>2</sub>	100	1	1	4	1	1	4	4	4	1	4	1
	Ethylene chloride	C <sub>2</sub> H <sub>4</sub> Cl <sub>2</sub>	100	3	3	4	1	3	4	4	4	1	-	1
	Ferrous chloride	FeCl <sub>2</sub>	saturated	1	3	1	3	1	1	1	1	1	-	4
	Formaldehyde solution	CH <sub>2</sub> O	30	1	3	1	1	1	-	-	-	1	2	1
	Formic acid	CH <sub>2</sub> O <sub>2</sub>	100	1	4	3	4	1	3	3	1	1	2	1
	Furfural	C <sub>5</sub> H <sub>4</sub> O <sub>2</sub>	100	1	3	3	2	4	-	-	-	1	4	1
	Gasoline	C <sub>5</sub> H <sub>12</sub> - C <sub>12</sub> H <sub>26</sub>	100	2	1	3	1	3	3	2	-	1	1	1
	Glycerol	C <sub>3</sub> H <sub>8</sub> O <sub>3</sub>	100	1	1	3	1	1	1	1	2	1	1	1
	Heptane, normal	C <sub>7</sub> H <sub>16</sub>	100	2	1	1	1	2	1	2	4	1	1	1
	Hexane, n-	C <sub>6</sub> H <sub>14</sub>	100	2	1	2	1	2	1	2	4	1	1	1
	Hydrogen chloride	HCl	5	1	4	1	4	1	1	1	-	1	2	4
	Hydrogen chloride	HCl	concentrated	1	4	4	4	1	1	2	3	1	4	4
	Hydrogen peroxide	H <sub>2</sub> O <sub>2</sub>	3	1	3	1	1	1	1	1	-	1	3	3
	Hydrogen peroxide	H <sub>2</sub> O <sub>2</sub>	30	1	4	1	4	1	1	1	-	1	3	3
	Hydrogen sulphide	H <sub>2</sub> S	10	1	1	1	1	1	1	1	3	1	3	1
	Iodine, tincture of	I <sub>2</sub>		1	4	3	1	1	-	4	4	1	1	1

## 11 Appendix

- no data 1 resistant 2 practically resistant 3 partially resistant 4 not resistant		Concentration	High Density Polyethylene	Polyamide	Polycarbonate	Polyoxymethylene	Polypropylene	Polysulfone	Polyvinyl chloride, hard	Polyvinyl chloride, soft	Polytetrafluorethylene	Acrylonitrile-butadiene-caoutchouc	Aluminium	
			Medium	Formula	[%]	HDPE	PA	PC	POM	PP	PSU	PVC	PVC	PTFE
	Isopropyl alcohol	C <sub>3</sub> H <sub>8</sub> O	100	1	1	1	1	1	1	1	4	1	-	2
	Lactic acid	C <sub>3</sub> H <sub>6</sub> O <sub>3</sub>	3	1	3	1	2	1	1	2	-	1	1	1
	Magnesium chloride	MgCl <sub>2</sub>	10	1	1	1	1	1	1	1	1	1	1	1
	Mercuric chloride	HgCl <sub>2</sub>	10	1	4	1	3	1	1	1	1	1	1	4
	Mercury	Hg	100	1	1	1	1	1	1	1	3	1	1	3
	Methyl acetate	C <sub>3</sub> H <sub>6</sub> O <sub>2</sub>	100	1	1	4	2	1	-	4	4	1	-	1
	Methyl alcohol	CH <sub>4</sub> O	100	1	2	4	1	1	3	1	3	1	2	1
	Methyl benzene	C <sub>7</sub> H <sub>8</sub>	100	3	1	4	1	3	4	4	4	1	4	1
	Methyl ethyl ketone (MEK)	C <sub>4</sub> H <sub>8</sub> O	100	1	1	4	1	1	4	4	4	1	4	1
	Methylene chloride	CH <sub>2</sub> Cl <sub>2</sub>	100	4	3	4	3	3	4	4	4	1	-	1
	Mineral oil	—	100	1	1	1	1	1	1	1	-	1	1	1
	Nitric acid	HNO <sub>3</sub>	10	1	4	1	4	1	1	1	-	1	4	3
	Nitric acid	HNO <sub>3</sub>	100	4	4	4	4	4	-	4	-	1	4	1
	Nitrobenzene	C <sub>6</sub> H <sub>5</sub> NO <sub>2</sub>	100	3	4	4	3	2	4	4	4	1	4	1
	Oleic acid	C <sub>18</sub> H <sub>34</sub> O <sub>2</sub>	100	1	1	1	2	1	-	1	-	1	3	1
	Oxalic acid	C <sub>2</sub> H <sub>2</sub> O <sub>4</sub> x 2H <sub>2</sub> O	100	1	3	1	4	1	1	1	1	1	2	1
	Ozone	O <sub>3</sub>	100	3	4	1	4	3	1	1	-	1	4	2
	Petroleum	—	100	1	1	3	1	1	1	1	3	1	1	1
	Phenol	C <sub>6</sub> H <sub>6</sub> O	10	1	4	4	4	1	4	1	3	1	3	1
	Phenol	C <sub>6</sub> H <sub>6</sub> O	100	2	4	4	4	1	3	4	3	1	3	1
	Phosphoric acid	H <sub>3</sub> PO <sub>4</sub>	20	1	4	2	4	1	-	-	-	1	2	4
	Phosphorus pentachloride	PCl <sub>5</sub>	100	-	4	4	4	1	-	4	4	1	-	1
	Potassium hydrogen carbonate	CHKO <sub>3</sub>	saturated	1	1	2	1	1	-	-	-	1	-	4
	Potassium hydroxide	KOH	30	1	1	4	3	1	1	1	1	1	-	4
	Potassium hydroxide	KOH	50	1	1	4	3	1	1	1	1	1	-	4
	Potassium nitrate	KNO <sub>3</sub>	10	1	1	1	1	1	-	-	-	1	1	1
	Potassium permanganate	KMnO <sub>4</sub>	100	1	4	1	1	1	-	1	-	1	3	1
	Pyridine	C <sub>5</sub> H <sub>5</sub> N	100	1	1	4	1	3	4	4	4	1	4	1
	Resorcinol	C <sub>6</sub> H <sub>6</sub> O <sub>2</sub>	5	1	4	2	3	1	4	2	-	1	-	2
	Silver nitrate	AgNO <sub>3</sub>	100	1	1	1	1	1	1	1	1	1	2	4

**11 Appendix**

Medium	Formula	Concentration [%]	- no data 1 resistant 2 practically resistant 3 partially resistant 4 not resistant										
			High Density Polyethylene HDPE	Polyamide PA	Polycarbonate PC	Polyoxymethylene POM	Polypropylene PP	Polysulfone PSU	Polyvinyl chloride, hard PVC	Polyvinyl chloride, soft PVC	Polytetrafluorethylene PTFE	Acrylonitrile-butadiene-caoutchouc NBR	Aluminium AL
Sodium bisulphite	NaHSO <sub>3</sub>	10	1	1	2	4	1	-	-	-	1	1	1
Sodium carbonate	Na <sub>2</sub> CO <sub>3</sub>	10	1	1	1	1	1	-	-	-	1	-	3
Sodium chloride	NaCl	30	1	1	1	1	1	1	1	1	1	1	3
Sodium hydroxide	NaOH	30	1	1	4	1	1	1	1	1	1	2	4
Sodium hydroxide	NaOH	50	1	1	4	1	1	1	1	-	1	2	4
Sodium sulfate	Na <sub>2</sub> SO <sub>4</sub>	10	1	1	1	1	1	1	1	1	1	1	1
Spirits	C <sub>2</sub> H <sub>6</sub> O	96	1	1	1	1	1	1	1	3	1	-	1
Styrene	C <sub>8</sub> H <sub>8</sub>	100	4	1	4	1	3	-	4	4	1	4	1
Sulphuric acid	H <sub>2</sub> SO <sub>4</sub>	6	1	4	1	4	1	1	1	-	1	2	3
Sulphuric acid	H <sub>2</sub> SO <sub>4</sub>	fuming	4	4	4	4	4	4	4	4	1	4	3
Tallow	—	100	1	1	1	1	1	-	1	1	1	1	1
Tetrahydrofuran (THF)	C <sub>4</sub> H <sub>8</sub> O	100	3	1	4	1	3	4	4	4	1	3	1
Tetrahydronaphthalene	C <sub>10</sub> H <sub>12</sub>	100	3	1	4	1	4	4	4	4	1	-	1
Thionyl chloride	Cl <sub>2</sub> SO	100	4	4	4	2	4	4	4	4	1	-	3
Tin chloride	SnCl <sub>2</sub>	10	1	4	2	2	1	-	-	-	1	1	4
Transformer oil	—	100	1	1	3	3	1	1	1	-	1	1	1
Trichloroethane	C <sub>2</sub> H <sub>3</sub> Cl <sub>3</sub>	100	3	3	4	2	4	4	4	4	1	4	4
Urea	CH <sub>4</sub> N <sub>2</sub> O	10	1	1	1	1	1	-	-	-	1	1	1
Urine	—	100	1	1	1	1	1	-	1	1	1	-	2
Vinegar	C <sub>2</sub> H <sub>4</sub> O <sub>2</sub>	10	1	4	1	1	1	1	1	1	1	2	1
Vinegar	C <sub>2</sub> H <sub>4</sub> O <sub>2</sub>	90	1	4	4	4	1	3	1	4	1	-	1
Wax	—	100	-	1	1		1	-	-	-	1	-	1
Wines	—	100	1	1	1	2	1	1	1	1	1	-	4
Xylene	C <sub>8</sub> H <sub>10</sub>	100	3	1	4	1	4	4	4	4	1	4	1

**11 Appendix**

---



## 11.6 EC declaration of conformity



### EC – DECLARATION OF CONFORMITY

The product named hereinafter was developed, designed, and manufactured in compliance with the relevant, fundamental safety and health requirements of the listed EC directives and norms.

In the event of modifications that were not authorised by us or if the product is used in a manner that is not in line with the intended purpose, this declaration will be rendered void.

<i>Product name:</i>	Laboratory centrifuge
<i>Product type:</i>	Sigma 3-16L
<i>Order number:</i>	10355, 10356, 10357
<i>Directives:</i>	2006/42/EC      Machinery Directive 2014/35/EU      Low Voltage Directive 2014/30/EU      EMC Directive (EU) 2015/863    RoHS Directive
<i>Normes:</i>	EN 61010-2-020:2017 EN IEC 61000-3-2:2019 EN 61000-3-3:2013 EN 61326-1:2013

**Sigma Laborzentrifugen GmbH**  
 An der Unteren Söse 50  
 37520 Osterode  
 Germany

Osterode, 07/04/2020

  
 General Manager

Authorised representative  
 for CE matters:  
 Eckhard Tödteberg

CE\_3-16L\_2020-04-07\_en
Page 1 / 1

**11 Appendix**

---





## EC – DECLARATION OF CONFORMITY

The product named hereinafter was developed, designed, and manufactured in compliance with the relevant, fundamental safety and health requirements of the listed EC directives and norms.

In the event of modifications that were not authorised by us or if the product is used in a manner that is not in line with the intended purpose, this declaration will be rendered void.

Product name:	Laboratory centrifuge
Product type:	Sigma 3-16L IVD
Order number:	10358, 10359
Directives:	98/79/EC In vitro Diagnostica (EU) 2015/863 RoHS Directive
Normes:	EN 61010-2-101:2017 EN 61010-2-020:2017 EN IEC 61000-3-2:2019 EN 61000-3-3:2013 EN 61326-1:2013

**Sigma Laborzentrifugen GmbH**  
 An der Unteren Söse 50  
 37520 Osterode  
 Germany

Authorised representative  
 for CE matters:  
 Eckhard Tödteberg

Osterode, 07/04/2020

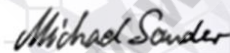

General Manager

**11 Appendix**

---





## 11.7 Declaration of conformity – China RoHS 2



### DECLARATION OF CONFORMITY

#### China RoHS 2 (Administrative Measures for the Restriction of the Use of Hazardous Substances in Electrical and Electronic Products)

Laboratory centrifuge models: Sigma 1-14, 1-14K, 1-7, 1-16, 1-16K, 2-7, 2-16P, 2-16KL, 2-16KHL, 3-16L, 3-16KL, 3-18KS, 3-18KHS, 3-30KS, 3-30KHS, 4-5L, 4-5KRL, 4-16S, 4-16KS, 4-16KHS, 4-16KRL, 6-16S, 6-16HS, 6-16KS, 6-16KHS, 6-16KRL, 8KS, 8KBS

Sigma Laborzentrifugen GmbH has made reasonable effort to avoid the use of hazardous substances in the products it manufactures (laboratory centrifuges).

A Product Conformity Assessment (PCA) was performed in order to determine whether the concentration of harmful substances in all homogeneous materials of the component parts is above or below the MCV limit (Maximum Concentration Value limit) as defined in GB/T 26572:

Mercury and its compounds: 0.1 %      Cadmium (Cd) and its compounds: 0.01 %  
Lead (Pb) and its compounds: 0.1 %      Hexavalent chromium (Cr (VI)) and its compounds: 0.1 %  
Polybrominated biphenyls (PBB): 0.1 %      Polybrominated diphenyl ethers (PBDE): 0.1 %

表1 产品中有害物质的名称及含量  
Table 1: Name and content of hazardous substances in the product

部件名称 Component part (PCA)	有害物质 Hazardous substance					
	铅 Lead (Pb)	汞 Mercury (Hg)	镉 Cadmium (Cd)	六价铬 Hexavalent Chromium (Cr (VI))	多溴联苯 Poly-brominated biphenyls (PBB)	多溴二苯醚 Polybrominated diphenyl ethers (PBDE)
Electronic PCB, cables	X <sup>1)</sup>	○	○	○	○	○
Display	○	○	○	○	○	○
Housing	X <sup>2)</sup>	○	○	○	○	○
Base, metal, accessories	X <sup>2)</sup>	○	○	○	○	○

本表格依据SJ/T 11364的规定编制。  
This table is made according to SJ/T 11364.

## 11 Appendix



O: 表示该有害物质在该部件所有均质材料中的含量均在GB/T 26572规定的限量要求以下。  
Indicates that the content of the harmful substance in all homogeneous materials of the component part is below the limit as defined in GB/T 26572.)

X: 表示该有害物质至少在该部件的某一均质材料中的含量超出GB/T 26572规定的限量要求。(企业可在此处, 根据实际情况对上表打“X”的技术原因进行进一步说明。)  
Indicates that the content of the harmful substance in at least one homogeneous material of the component part exceeds the limit as defined in GB/T 26572. (Contact the manufacturer for further technical information according to the actual situation.)

1) Contains parts in compliance with exemptions 6c, 7c.I, 7c.II and 37 of 2011/65/EU RoHS.

2) Contains parts in compliance with exemptions 6a, 6b and 6c of 2011/65/EU RoHS.

Apart from the exemptions given in this table, none of the substances listed above have been intentionally added to the product or metallic coatings.

### Sigma Laborzentrifugen GmbH

An der Unteren Söse 50  
37520 Osterode

Germany

Osterode, 20/11/2017



General Manager

## 12 Index

<b>A</b>	
Acceleration .....	38
Acceleration curves.....	38, 62
Accessories, cleaning and care.....	49
Acid.....	20, 48, 49
Activating the modification mode.....	34
Adapters .....	32, 49
Alkaline solutions .....	20, 48, 49
Ambient conditions.....	59
Ambient temperature .....	59
Anodised coating .....	49
Application examples .....	13
Autoclaving .....	53
Automatic lid opening function .....	39
AutoOpen .....	39
<b>B</b>	
Brake .....	38
Brief mains power failure.....	44
Bucket.....	32
Buckets, cleaning and care .....	50
Buzzer .....	39
<b>C</b>	
Capacity.....	58
Carrier.....	32
Carrier systems.....	32
Carriers, cleaning and care .....	50
CE mark in compliance with the directive 2006/42/EC .....	15
Centrifugation of infectious, toxic, radioactive, or pathogenic substances.....	19
Centrifugation principle .....	13
Centrifugation with low capacity .....	31
Centrifugation with vessels of various sizes	31
Centrifuge cannot be started.....	44
Centrifuge decelerates during operation ....	44
Centrifuge is inclined.....	44
Centrifuge was moved during run .....	44
Centrifuge, cleaning and care .....	48
Changes in colour.....	53
Changes in structure.....	53
Chemical and biological safety.....	19
Chemical resistance of plastic.....	49
China RoHS 2 – Declaration of conformity .	73
Cleaning agents .....	52
Cleaning the bores of angle rotors .....	49
Cleaning the centrifuge .....	48
Closing the lid .....	18, 28
Communication error .....	46
Condensation.....	26
Condenser dirty .....	44
Contamination.....	19, 49
Continuous heat resistance.....	52
Continuous run .....	36
Control system.....	33
Copyright .....	10
Corrosion .....	18, 21, 32, 48, 49, 50, 52
Cost estimate.....	55
Cracking .....	49
Cracks .....	50
Customer-provided fuses .....	27
Cycle display (Cycles).....	40
Cycles.....	29
Cycles (cycle display) .....	40
<b>D</b>	
Damage of the surface.....	50
Dangerous goods.....	20
Dangerous materials.....	52
Date of manufacture .....	12
Deceleration curves .....	38, 62
Declaration of conformity .....	10, 69
Declaration of conformity – China RoHS 2 .	73
Declaration of decontamination.....	55, 57
Decontamination agent .....	49, 52
Deformation of tubes.....	53
Density.....	12, 20
Different service life of rotors and accessories .....	21, 63
Dimensions .....	24
Direct hazard to the life and health.....	16
Directive 2002/96/EC .....	57
Disinfectants .....	52

## Index

Disinfection of the rotor chamber and accessories .....	52	Initial start-up .....	28
Display .....	33	Input lock .....	41
Disposal of the centrifuge.....	57	Inspection by the manufacturer .....	54
Disposal of the packaging .....	57	Installation of a standard angle rotor with a hermetic lid.....	29
Documentation.....	10	Installation of a standard rotor.....	29
Drive problem .....	44	Installation of accessories .....	31
<b>E</b>		Installation of rotors and accessories .....	29
Earth conductor check .....	22	Installation site .....	26
EC declaration of conformity .....	10, 69	Installing a rotor with the g-lock® system ...	30
EEPROM error.....	46	Insufficiently greased load-bearing bolts ....	51
Electrical connection .....	58	Intended use .....	9
Electrical safety.....	18	Interrupting a centrifugation run .....	34
Emergency lid release .....	45	Interrupting a deceleration process .....	34
Error correction .....	44	IP code .....	58
Error message .....	44	<b>K</b>	
Explanation of the symbols and notes.....	16	Kinetic energy .....	12, 58
Explosive substances .....	19	<b>L</b>	
<b>F</b>		Layout of the centrifuge.....	11
Fire preventions .....	19	Leaks .....	53
Form for the return of defective parts .....	55	Lid cannot be opened .....	44
Functional and operating elements .....	11	Lid error .....	46
Fuses have tripped .....	44	Lid lock device .....	22
<b>G</b>		Lid lock has not released .....	44
General conditions .....	9	Lid seal sticks .....	44
Glass breakage.....	52	Linear curves .....	62
Glass particles .....	52	Loading a program.....	43
Gravitational field .....	58	<b>M</b>	
Grease for load-bearing bolts.....	48, 51	Mains power switch off.....	44
<b>H</b>		Mains switch .....	11
Hazard warnings .....	9, 29, 32	Mains voltage.....	18
Heavy-duty grease for load-bearing bolts...	51	Maintenance .....	48
Highly corrosive substances .....	18	Malfunctions and error correction.....	44
<b>I</b>		Manual mode .....	34
Imbalance .....	31, 32	Manufacturer.....	58
Imbalance error.....	46	Marking of the unit .....	15
Imbalance monitoring system .....	22	Maximum number of cycles .....	40
Importance of the operating manual.....	9	Maximum speed for tubes.....	32
Important information .....	16	Measures in the event of hazards and accidents .....	23
Improper loading.....	44	Mechanical safety .....	18
Infectious substances .....	52	Mode of operation.....	13
Inflammable substances .....	19	Motor error .....	46
Informal safety instructions .....	17	Motor shaft.....	29, 48

Multiple carrier .....	32	Removal of the transport safety device .....	25
<b>N</b>		Remove glass particles and metal dust from the rotor chamber .....	52
Name plate .....	11, 12	Responsibility of the operator .....	17
No indication on the display .....	44	Return of centrifuges, spare parts, or accessories .....	55
No power in the mains supply .....	44	Return of defective parts .....	55
Noise level .....	58	Risk of electrical shock .....	18
Nominal voltage .....	12	Rotor chamber .....	48
Notes on safety and hazards .....	9	Rotor monitoring system .....	22
Notes on transport .....	24	Rotor radii .....	60
<b>O</b>		Rotor selection .....	37
Online download of forms .....	56	Rotor tie-down screw .....	29, 50
Opening the lid .....	28	Rotor with the g-lock® system, installation ..	30
Operating personnel .....	17	Rotor wrench .....	29
Operating voltage .....	26	Rotors and accessories with a different service life .....	21, 63
Operational safety .....	49	Rotors for microtiter plate formats .....	29
Overseas shipping .....	24	Rotors, cleaning and care .....	50
<b>P</b>		Runtime .....	35
Packaging .....	25	Runtime as of the set speed .....	36
Parameter error .....	46	<b>S</b>	
Pathogenic substances .....	19, 48, 52	Safety area .....	20
Plastic accessories, cleaning and care .....	49	Safety devices .....	22
Potential hazard to the life and health .....	16	Safety distance .....	18, 20, 26
Potentially hazardous situation .....	16	Safety instructions .....	9, 29, 32
Power consumption .....	12, 58	Safety instructions for centrifugation .....	20
Power cord is not plugged in .....	44	Safety of rotors and accessories .....	21
Power supply .....	26	Safety, chemical and biological .....	19
Preselection of a curve .....	38	Safety, electrical .....	18
Pressure marks .....	50	Safety, mechanical .....	18
Prevention of accidents .....	9	Safety-conscious work .....	17
Problem description .....	55	Saving a program .....	42
Process error .....	46	Scope of supply .....	10
ProgLock program lock .....	40	Selection, display, and modification of data ..	34
Program lock (ProgLock) .....	40	Serial number .....	12, 47, 54
Protection class .....	26, 58	Service .....	54
<b>Q</b>		Service contact .....	47
Quick stop .....	34	Service life .....	48
Quitting the modification mode .....	34	Service life of rotors and accessories ..	21, 63
<b>R</b>		Service life of the accessories .....	53
Radioactive substances .....	19, 48	Service work .....	54
Radius .....	14	Set-up and connection .....	26
Reaching the maximum number of cycles ..	40	Short run .....	37
Relative centrifugal force (RCF) .....	14, 35	Solvents .....	20, 48, 49
Removal of a rotor .....	30		

## Index

Sound signal (buzzer) .....	39	Technical data .....	58
Spare part enquiries.....	47	Technical documentation .....	59
Speed .....	12, 14, 35, 58	Temperature error.....	46
Speed-gravitational-field-diagram .....	61	Temperature value not reached .....	44
Speedometer error.....	46	Thermal circuit breaker .....	58
Standards and regulations .....	10	Thermal stress .....	48
Standstill monitoring system .....	22	Time range.....	58
Starting a centrifugation run .....	34	Toxic substances .....	19, 48
Sterilisation of the rotor chamber and accessories .....	52	Transport safety device.....	25
Stopping of the centrifuge due to an imbalance.....	51	Tubes.....	32
Storage and transport .....	24	Type.....	12, 58
Storage conditions .....	24	Type of connection.....	26
Storage locations .....	58	Type of the centrifuge .....	47, 54
Stress-corrosion		<b>U</b>	
see		Ungreased load-bearing bolts .....	44
corrosion .....	50	Useful volume	
Structural changes .....	19	- volume that is stated for the tube .....	32
Supply voltage .....	26	User interface .....	33
Switching the centrifuge off .....	43	UV radiation .....	26, 48
Switching the centrifuge on .....	28	<b>V</b>	
System check .....	22	Vents .....	26
System error .....	44, 46	Vessels .....	32
<b>T</b>		<b>W</b>	
Table of error codes.....	46	Warranty and liability.....	9
Table of rotors and accessories with a different service life .....	21, 63	Wear.....	54
		Weight .....	24



**LABORATORY EQUIPMENT MAINTENANCE, REPAIR, CALIBRATION AND SALES**

Established in 1987, Henderson Biomedical is the UK's leading laboratory equipment sales and service provider. Our knowledgeable team can provide you with excellent sales advice on a range of different types of laboratory equipment including centrifuges, refrigerators, freezers and heat sealers.

Henderson Biomedical is also able to provide you with first class after-sales service and calibration of your laboratory equipment. We are an **ISO 17025 (UKAS) accredited calibration test laboratory** and our team of Field Service Engineers cover the whole of the United Kingdom.

Please contact us for more information on the types of equipment we supply and the different after-sales services we can offer.

**Henderson Biomedical**

Unit 3, Swan Close  
Croydon CR0 2DZ  
United Kingdom

**Tel: 020 8663 4610**

For sales enquiries: [sales@henderson-biomedical.co.uk](mailto:sales@henderson-biomedical.co.uk)  
For all other enquiries: [info@henderson-biomedical.co.uk](mailto:info@henderson-biomedical.co.uk)  
[www.henderson-biomedical.co.uk](http://www.henderson-biomedical.co.uk)

